

GENERAL DESCRIPTION

The SGM2037 is a low noise, low dropout voltage linear regulator which is designed using CMOS technology. It provides 500mA output current capability. The operating input voltage range is from 0.8V to 5.5V and bias supply voltage range is from 2.5V to 5.5V. The output voltage range is from 0.8V to 3.6V.

Other features include logic-controlled shutdown mode, short-circuit current limit and thermal shutdown protection. The SGM2037 has automatic discharge function to quickly discharge V_{OUT} in the disabled status.

The SGM2037 is suitable for applications which need low noise, fast transient response and low I_Q consumption, such as battery-powered equipment and smartphones, etc.

The SGM2037 is available in Green SOT-23-5, SOT-23-6 and UTDFN-1.2×1.2-6L packages. It operates over an ambient temperature range of -40°C to $+125^{\circ}\text{C}$.

APPLICATIONS

- Portable Equipment
- Smartphone
- Industrial and Medical Equipment

TYPICAL APPLICATION

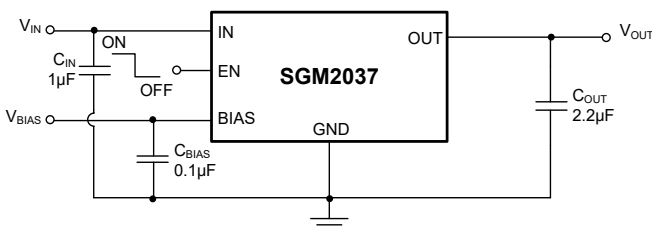

Figure 1. Fixed Voltage Typical Application Circuit

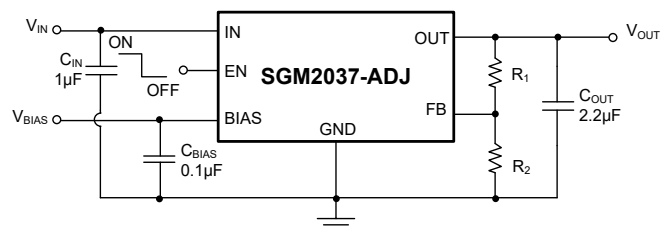

Figure 2. Adjustable Voltage Typical Application Circuit

FEATURES

- 500mA Nominal Output Current
- Input Voltage Range: 0.8V to 5.5V
- Bias Voltage Range: 2.5V to 5.5V
- Fixed Output Voltages: 0.8V, 0.9V, 1.0V, 1.05V, 1.1V, 1.15V, 1.2V, 1.25V, 1.3V, 1.5V, 1.8V, 2.5V, 2.8V, 3.0V, 3.3V, and 3.6V
- Adjustable Output Voltage Range: 0.8V to 3.6V
- Output Voltage Accuracy: $\pm 0.8\%$ at $+25^{\circ}\text{C}$
- Low Dropout Voltage: 120mV (TYP) at 500mA
- Very Low Bias Input Current: 37 μA (TYP)
- Very Low Bias Input Current in Shutdown: 0.01 μA (TYP)
- Low Noise: 25 μV_{RMS} (TYP)
- Over-Current and Over-Temperature Protections
- Fast Load Transient Response
- Logic Level Enable Input for ON/OFF Control
- -40°C to $+125^{\circ}\text{C}$ Operating Temperature Range
- Available in Green SOT-23-5, SOT-23-6 and UTDFN-1.2×1.2-6L Packages

PACKAGE/ORDERING INFORMATION

MODEL	PACKAGE DESCRIPTION	SPECIFIED TEMPERATURE RANGE	ORDERING NUMBER	PACKAGE MARKING	PACKING OPTION
SGM2037-0.8	SOT-23-5	-40°C to +125°C	SGM2037-0.8XN5G/TR	GP6XX	Tape and Reel, 3000
SGM2037-0.9	SOT-23-5	-40°C to +125°C	SGM2037-0.9XN5G/TR	GV1XX	Tape and Reel, 3000
SGM2037-1.0	SOT-23-5	-40°C to +125°C	SGM2037-1.0XN5G/TR	GV2XX	Tape and Reel, 3000
SGM2037-1.05	SOT-23-5	-40°C to +125°C	SGM2037-1.05XN5G/TR	GV3XX	Tape and Reel, 3000
SGM2037-1.1	SOT-23-5	-40°C to +125°C	SGM2037-1.1XN5G/TR	GV4XX	Tape and Reel, 3000
SGM2037-1.15	SOT-23-5	-40°C to +125°C	SGM2037-1.15XN5G/TR	GV5XX	Tape and Reel, 3000
SGM2037-1.2	SOT-23-5	-40°C to +125°C	SGM2037-1.2XN5G/TR	GV6XX	Tape and Reel, 3000
SGM2037-1.25	SOT-23-5	-40°C to +125°C	SGM2037-1.25XN5G/TR	GV7XX	Tape and Reel, 3000
SGM2037-1.3	SOT-23-5	-40°C to +125°C	SGM2037-1.3XN5G/TR	GV8XX	Tape and Reel, 3000
SGM2037-1.5	SOT-23-5	-40°C to +125°C	SGM2037-1.5XN5G/TR	GV9XX	Tape and Reel, 3000
SGM2037-1.8	SOT-23-5	-40°C to +125°C	SGM2037-1.8XN5G/TR	GVAXX	Tape and Reel, 3000
SGM2037-2.5	SOT-23-5	-40°C to +125°C	SGM2037-2.5XN5G/TR	GVBXX	Tape and Reel, 3000
SGM2037-2.8	SOT-23-5	-40°C to +125°C	SGM2037-2.8XN5G/TR	GVCXX	Tape and Reel, 3000
SGM2037-3.0	SOT-23-5	-40°C to +125°C	SGM2037-3.0XN5G/TR	GVDXX	Tape and Reel, 3000
SGM2037-3.3	SOT-23-5	-40°C to +125°C	SGM2037-3.3XN5G/TR	GVEXX	Tape and Reel, 3000
SGM2037-3.6	SOT-23-5	-40°C to +125°C	SGM2037-3.6XN5G/TR	M35XX	Tape and Reel, 3000
SGM2037-ADJ	SOT-23-6	-40°C to +125°C	SGM2037-ADJXN6G/TR	GVFXX	Tape and Reel, 3000
SGM2037-0.8	UTDFN-1.2×1.2-6L	-40°C to +125°C	SGM2037-0.8XUDX6G/TR	36 XX	Tape and Reel, 5000
SGM2037-0.9	UTDFN-1.2×1.2-6L	-40°C to +125°C	SGM2037-0.9XUDX6G/TR	Z9 XX	Tape and Reel, 5000
SGM2037-1.0	UTDFN-1.2×1.2-6L	-40°C to +125°C	SGM2037-1.0XUDX6G/TR	ZA XX	Tape and Reel, 5000
SGM2037-1.05	UTDFN-1.2×1.2-6L	-40°C to +125°C	SGM2037-1.05XUDX6G/TR	ZB XX	Tape and Reel, 5000
SGM2037-1.1	UTDFN-1.2×1.2-6L	-40°C to +125°C	SGM2037-1.1XUDX6G/TR	ZC XX	Tape and Reel, 5000
SGM2037-1.15	UTDFN-1.2×1.2-6L	-40°C to +125°C	SGM2037-1.15XUDX6G/TR	ZD XX	Tape and Reel, 5000
SGM2037-1.2	UTDFN-1.2×1.2-6L	-40°C to +125°C	SGM2037-1.2XUDX6G/TR	ZE XX	Tape and Reel, 5000
SGM2037-1.25	UTDFN-1.2×1.2-6L	-40°C to +125°C	SGM2037-1.25XUDX6G/TR	ZF XX	Tape and Reel, 5000
SGM2037-1.3	UTDFN-1.2×1.2-6L	-40°C to +125°C	SGM2037-1.3XUDX6G/TR	00 XX	Tape and Reel, 5000
SGM2037-1.5	UTDFN-1.2×1.2-6L	-40°C to +125°C	SGM2037-1.5XUDX6G/TR	01 XX	Tape and Reel, 5000
SGM2037-1.8	UTDFN-1.2×1.2-6L	-40°C to +125°C	SGM2037-1.8XUDX6G/TR	02 XX	Tape and Reel, 5000
SGM2037-2.5	UTDFN-1.2×1.2-6L	-40°C to +125°C	SGM2037-2.5XUDX6G/TR	03 XX	Tape and Reel, 5000

PACKAGE/ORDERING INFORMATION (continued)

MODEL	PACKAGE DESCRIPTION	SPECIFIED TEMPERATURE RANGE	ORDERING NUMBER	PACKAGE MARKING	PACKING OPTION
SGM2037-2.8	UTDFN-1.2×1.2-6L	-40°C to +125°C	SGM2037-2.8XUDX6G/TR	04 XX	Tape and Reel, 5000
SGM2037-3.0	UTDFN-1.2×1.2-6L	-40°C to +125°C	SGM2037-3.0XUDX6G/TR	05 XX	Tape and Reel, 5000
SGM2037-3.3	UTDFN-1.2×1.2-6L	-40°C to +125°C	SGM2037-3.3XUDX6G/TR	06 XX	Tape and Reel, 5000
SGM2037-3.6	UTDFN-1.2×1.2-6L	-40°C to +125°C	SGM2037-3.6XUDX6G/TR	37 XX	Tape and Reel, 5000
SGM2037-ADJ	UTDFN-1.2×1.2-6L	-40°C to +125°C	SGM2037-ADJXUDX6G/TR	07 XX	Tape and Reel, 5000

MARKING INFORMATION

NOTE: XX = Date Code.

SOT-23-6/SOT-23-5

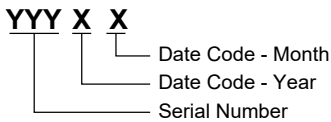

UTDFN-1.2×1.2-6L

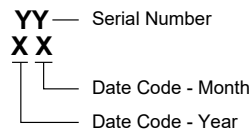

Green (RoHS & HSF): SG Micro Corp defines "Green" to mean Pb-Free (RoHS compatible) and free of halogen substances. If you have additional comments or questions, please contact your SGMICRO representative directly.

ABSOLUTE MAXIMUM RATINGS

- IN, BIAS, EN to GND -0.3V to 6V
- OUT, FB to GND -0.3V to (V_{IN} + 0.3V)
- Power Dissipation, P_D @ T_A = +25°C
- SOT-23-5 584mW
- SOT-23-6 641mW
- UTDFN-1.2×1.2-6L 612mW
- Package Thermal Resistance
- SOT-23-5, θ_{JA} 214°C/W
- SOT-23-6, θ_{JA} 195°C/W
- UTDFN-1.2×1.2-6L, θ_{JA} 204°C/W
- Junction Temperature +150°C
- Storage Temperature Range..... -65°C to +150°C
- Lead Temperature (Soldering, 10s)..... +260°C
- ESD Susceptibility
- HBM..... 8000V
- MM..... 400V
- CDM 1000V

RECOMMENDED OPERATING CONDITIONS

- Operating Input Voltage Range, V_{IN}..... 0.8V to 5.5V
- Operating Bias Voltage Range, V_{BIAS}..... 2.5V to 5.5V
- BIAS Effective Capacitance, C_{BIAS}..... 0.1µF (MIN)
- Input Effective Capacitance, C_{IN} 0.5µF (MIN)
- Output Effective Capacitance, C_{OUT}..... 1µF to 10µF
- Operating Temperature Range -40°C to +125°C

OVERSTRESS CAUTION

Stresses beyond those listed in Absolute Maximum Ratings may cause permanent damage to the device. Exposure to absolute maximum rating conditions for extended periods may affect reliability. Functional operation of the device at any conditions beyond those indicated in the Recommended Operating Conditions section is not implied.

ESD SENSITIVITY CAUTION

This integrated circuit can be damaged if ESD protections are not considered carefully. It recommends that all integrated circuits be handled with appropriate precautions. Failure to observe proper handling and installation procedures can cause damage. ESD damage can range from subtle performance degradation to complete device failure. Precision integrated circuits may be more susceptible to damage because even small parametric changes could cause the device not to meet the published specifications.

DISCLAIMER

We reserve the right to make any change in circuit design, or specifications without prior notice.

PIN CONFIGURATIONS

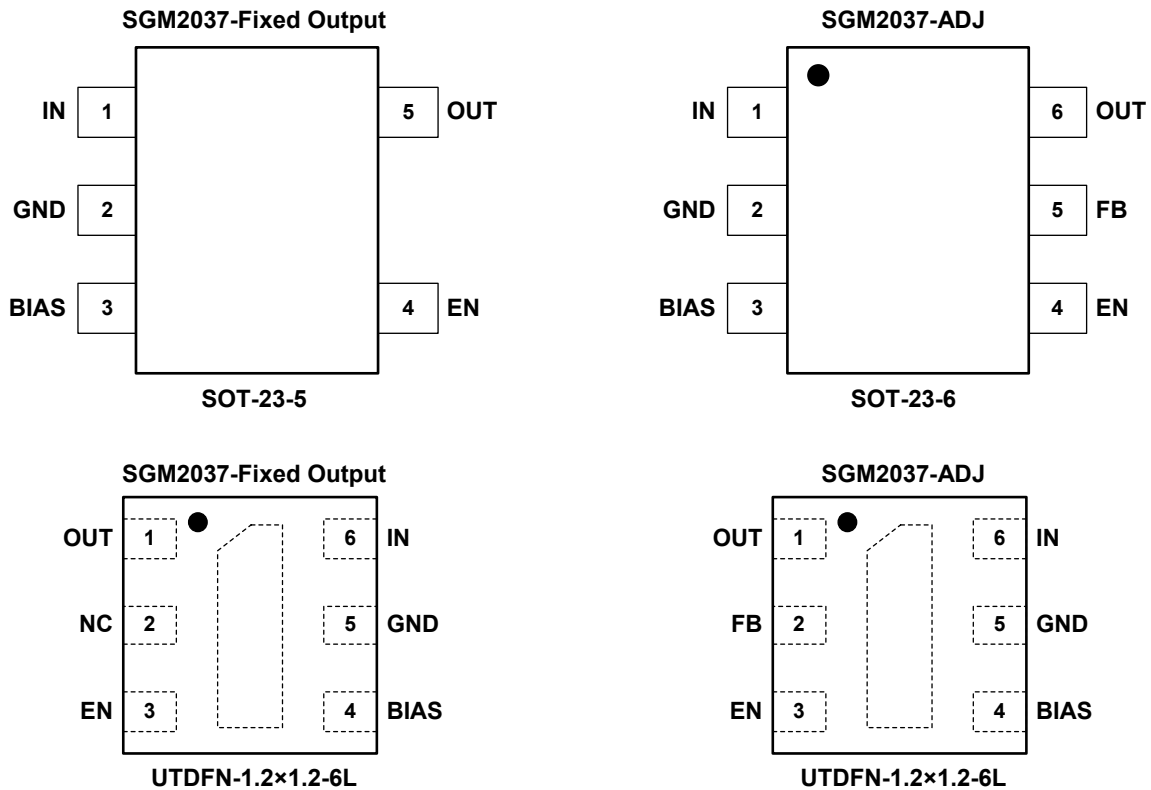

PIN DESCRIPTION

PIN			NAME	FUNCTION
SOT-23-5	SOT-23-6	UTDFN-1.2x1.2-6L		
1	1	6	IN	Input Voltage Supply Pin.
2	2	5	GND	Ground.
3	3	4	BIAS	Bias Voltage Supply for Internal Control Circuits. This pin is monitored by internal under-voltage lockout circuit.
4	4	3	EN	Enable Pin. Drive EN high to turn on the regulator. Drive EN low to turn off the regulator. The EN pin has an internal pull-down resistance which ensures that the device is turned off when the EN pin is floated.
5	6	1	OUT	Regulated Output Voltage Pin. It is recommended to use output capacitor with effective capacitance in the range of 1µF to 10µF.
-	5	2	FB	Feedback Pin (adjustable voltage version only). Connect this pin to the midpoint of an external resistor divider to adjust the output voltage.
-	-		NC	No Connection (fixed voltage version).
-	-	Exposed Pad	-	Exposed Pad. Exposed pad is internally connected to GND. Connect it to a large ground plane to maximize thermal performance; not intended as an electrical connection point.

ELECTRICAL CHARACTERISTICS

($V_{BIAS} = 2.7V$ or ($V_{OUT(NOM)} + 1.6V$), whichever is greater, $V_{EN} = V_{BIAS}$, $V_{IN} = V_{OUT(NOM)} + 0.3V$, $I_{OUT} = 1mA$, $C_{IN} = 1\mu F$, $C_{BIAS} = 0.1\mu F$, $C_{OUT} = 2.2\mu F$, Full = $-40^{\circ}C$ to $+125^{\circ}C$, unless otherwise noted.)

PARAMETER	SYMBOL	CONDITIONS	TEMP	MIN	TYP	MAX	UNITS
Operating Input Voltage Range	V_{IN}		$+25^{\circ}C$	$V_{OUT(NOM)} + V_{DROP_IN}$		5.5	V
Operating Bias Voltage Range	V_{BIAS}		$+25^{\circ}C$	$(V_{OUT(NOM)} + 1.4) \geq 2.5$		5.5	V
Under-Voltage Lockout Threshold	V_{UVLO}	V_{BIAS} rising	$+25^{\circ}C$		1.6		V
		Hysteresis	$+25^{\circ}C$		0.2		
Feedback Voltage	V_{FB}	SGM2037-ADJ, $V_{OUT} = V_{FB}$, $I_{OUT} = 1mA$ to $500mA$	$+25^{\circ}C$	0.7936	0.8	0.8064	V
Output Voltage Accuracy	V_{OUT}	$V_{IN} = (V_{OUT(NOM)} + 0.3V)$ to $(V_{OUT(NOM)} + 1.0V)$, $V_{BIAS} = 2.7V$ or $(V_{OUT(NOM)} + 1.6V)$ to $5.5V$, $I_{OUT} = 1mA$ to $500mA$	$+25^{\circ}C$	-0.8		0.8	%
			Full	-1.5		1.5	
V_{IN} Line Regulation	$\frac{\Delta V_{OUT}}{\Delta V_{IN} \times V_{OUT}}$	$V_{IN} = (V_{OUT(NOM)} + 0.3V)$ to $5.5V$	$+25^{\circ}C$		0.002	0.03	%/V
V_{BIAS} Line Regulation	$\frac{\Delta V_{OUT}}{\Delta V_{BIAS} \times V_{OUT}}$	$V_{BIAS} = 2.7V$ or $(V_{OUT(NOM)} + 1.6V)$ to $5.5V$, $0.8V \leq V_{OUT(NOM)} \leq 1.8V$ $V_{BIAS} = (V_{OUT(NOM)} + 1.6V)$ to $5.5V$, $1.8V < V_{OUT(NOM)} \leq 3.6V$	$+25^{\circ}C$		0.002	0.03	%/V
			$+25^{\circ}C$		0.005	0.1	
Load Regulation	ΔV_{OUT}	$I_{OUT} = 1mA$ to $500mA$, $0.8V \leq V_{OUT(NOM)} \leq 1.8V$	$+25^{\circ}C$		0.5	2	mV
		$I_{OUT} = 1mA$ to $500mA$, $1.8V < V_{OUT(NOM)} \leq 3.6V$	$+25^{\circ}C$		1	5	
V_{IN} Dropout Voltage ⁽¹⁾	V_{DROP_IN}	$I_{OUT} = 150mA$	$+25^{\circ}C$		35	50	mV
		$I_{OUT} = 500mA$	$+25^{\circ}C$		120	170	
V_{BIAS} Dropout Voltage ⁽¹⁾⁽²⁾	V_{DROP_BIAS}	$I_{OUT} = 500mA$	$+25^{\circ}C$		1.2	1.5	V
Output Current Limit	I_{LIM}		$+25^{\circ}C$	505	670		mA
Short Current Limit	I_{SHORT}	$V_{OUT} = 0V$	$+25^{\circ}C$		340		mA
FB Pin Input Current	I_{FB}		$+25^{\circ}C$	-20		20	nA
			Full	-30		30	
BIAS Pin Operating Current	I_{BIAS}	$V_{BIAS} = 5.5V$	$+25^{\circ}C$		37	53	μA
			Full			55	
IN Pin Disable Current	I_{DIS_IN}	$V_{EN} = 0V$	$+25^{\circ}C$		0.1	0.5	μA
			Full			1.6	
BIAS Pin Disable Current	I_{DIS_BIAS}	$V_{EN} = 0V$	$+25^{\circ}C$		0.01	0.5	μA
			Full			2.5	
EN Pin Threshold Voltage	V_{IH}	EN input voltage high	Full	1.2			V
	V_{IL}	EN input voltage low	Full			0.25	V
EN Pin Pull-Down Resistance	R_{EN}		$+25^{\circ}C$		580		k Ω
Turn-On Time	t_{ON}	From assertion of V_{EN} to $V_{OUT} = 90\%V_{OUT(NOM)}$	$+25^{\circ}C$		100		μs
V_{IN} Power Supply Rejection Ratio	PSRR	V_{IN} to V_{OUT} , $f = 1kHz$, $V_{OUT(NOM)} = 1.0V$, $I_{OUT} = 150mA$, $V_{IN} \geq 1.5V$	$+25^{\circ}C$		71		dB
V_{BIAS} Power Supply Rejection Ratio			$+25^{\circ}C$		76		
Output Voltage Noise	e_n	$V_{IN} = V_{OUT(NOM)} + 0.5V$, $V_{OUT(NOM)} = 1.0V$, $f = 10Hz$ to $100kHz$	$+25^{\circ}C$		25		μV_{RMS}
Output Discharge Resistance	R_{DISCH}	$V_{EN} = 0V$, $V_{OUT} = 0.5V$	$+25^{\circ}C$		120		Ω
Thermal Shutdown Temperature	T_{SHDN}				160		$^{\circ}C$
Thermal Shutdown Hysteresis	ΔT_{SHDN}				20		$^{\circ}C$

NOTES:

- Dropout voltage is characterized when V_{OUT} falls 5% below $V_{OUT(NOM)}$.
- For output voltages below 1.5V, V_{BIAS} dropout voltage does not apply due to a minimum bias operating voltage of 2.5V.

TYPICAL PERFORMANCE CHARACTERISTICS

$T_A = +25^\circ\text{C}$, $V_{IN} = 1.3\text{V}$, $V_{EN} = V_{BIAS} = 2.7\text{V}$, $V_{OUT(NOM)} = 1.0\text{V}$, $C_{IN} = 1\mu\text{F}$, $C_{BIAS} = 0.1\mu\text{F}$, $C_{OUT} = 2.2\mu\text{F}$, unless otherwise noted.

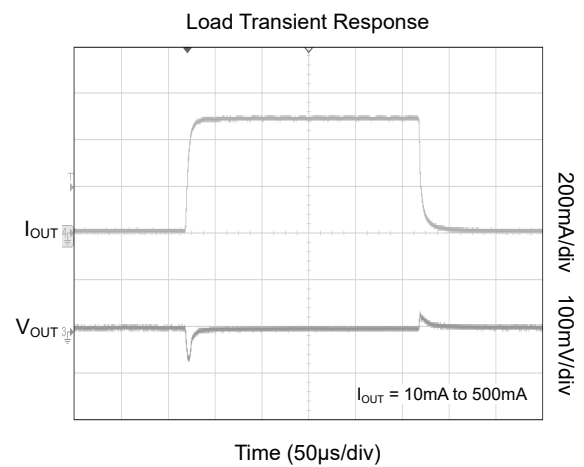
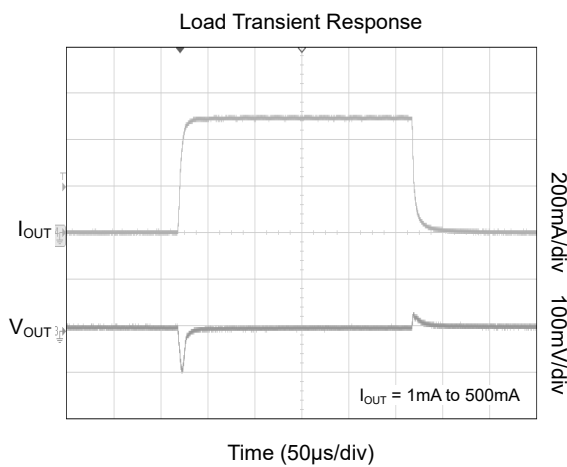
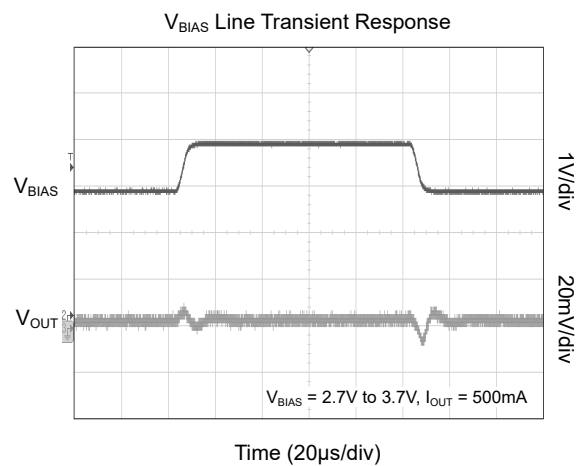
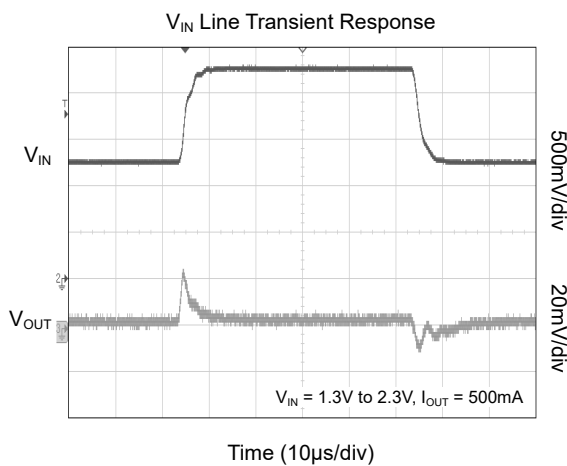
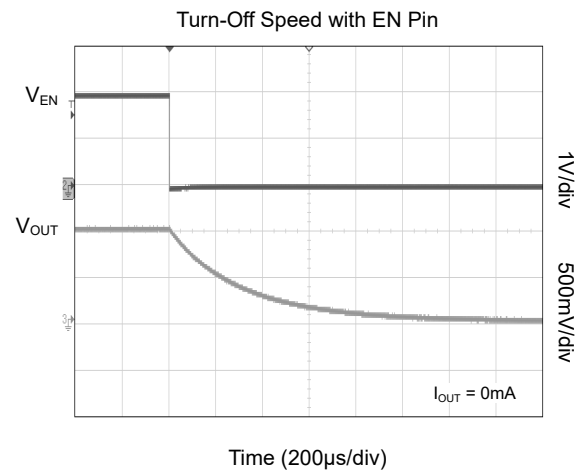
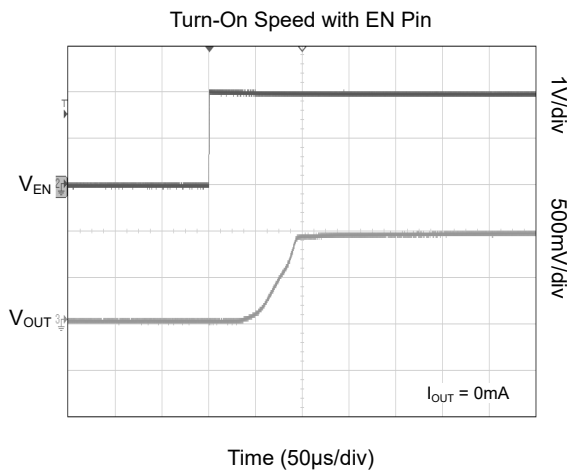

TYPICAL PERFORMANCE CHARACTERISTICS (continued)

$T_A = +25^\circ\text{C}$, $V_{IN} = 1.3\text{V}$, $V_{EN} = V_{BIAS} = 2.7\text{V}$, $V_{OUT(NOM)} = 1.0\text{V}$, $C_{IN} = 1\mu\text{F}$, $C_{BIAS} = 0.1\mu\text{F}$, $C_{OUT} = 2.2\mu\text{F}$, unless otherwise noted.

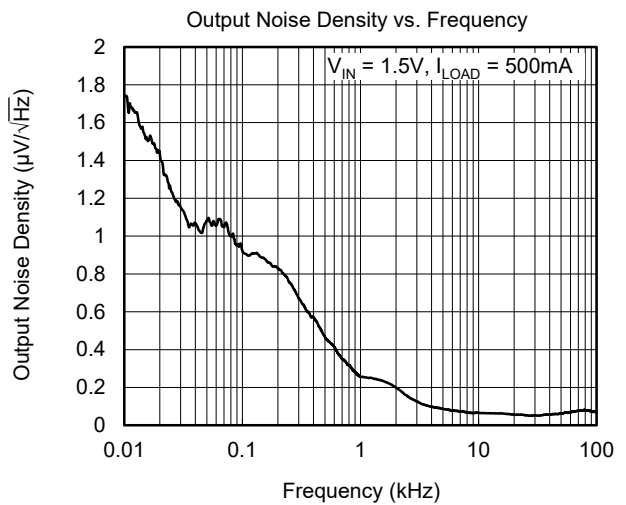
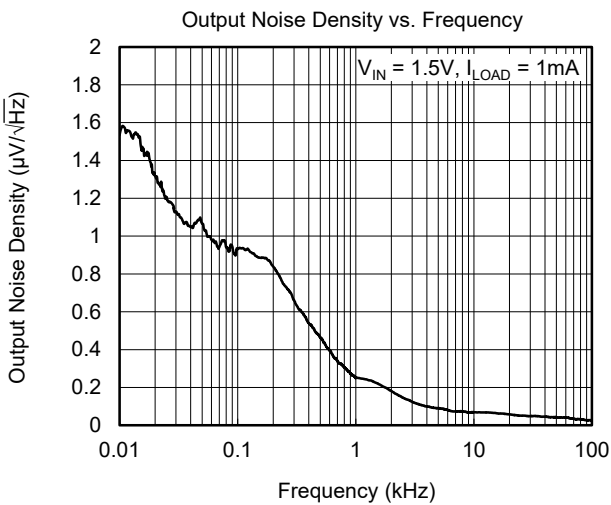
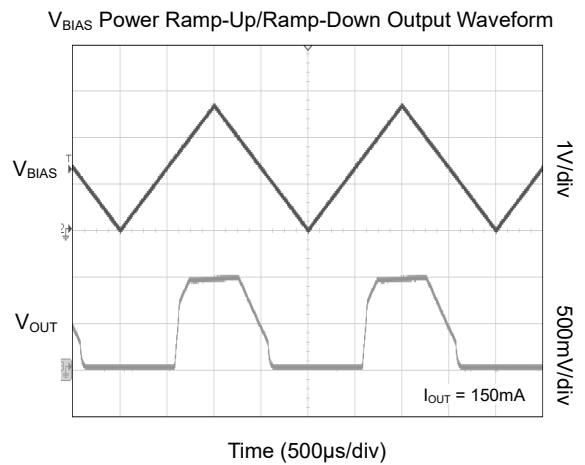
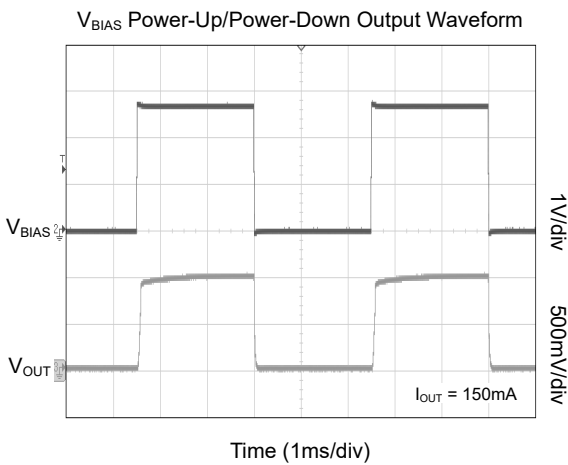
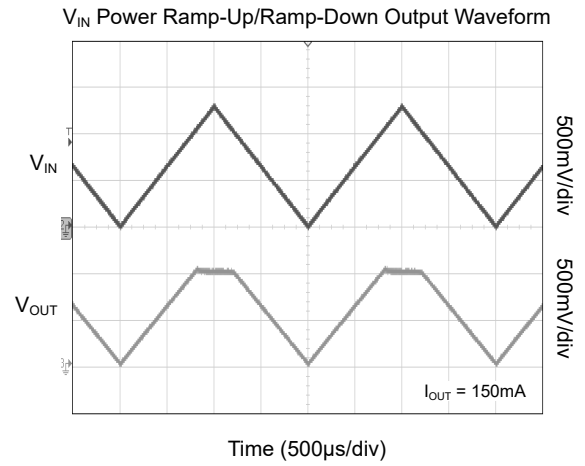
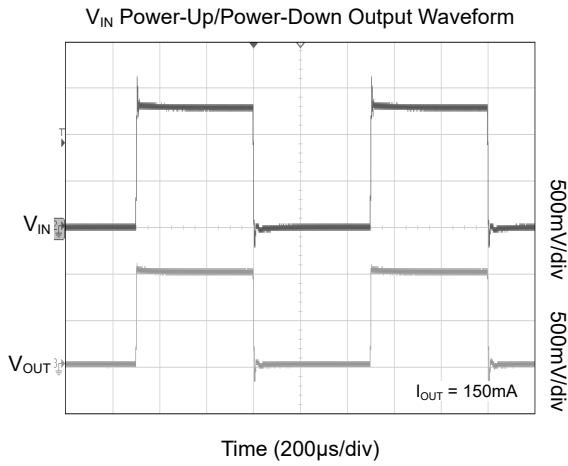

TYPICAL PERFORMANCE CHARACTERISTICS (continued)

$T_A = +25^\circ\text{C}$, $V_{IN} = 1.3\text{V}$, $V_{EN} = V_{BIAS} = 2.7\text{V}$, $V_{OUT(NOM)} = 1.0\text{V}$, $C_{IN} = 1\mu\text{F}$, $C_{BIAS} = 0.1\mu\text{F}$, $C_{OUT} = 2.2\mu\text{F}$, unless otherwise noted.

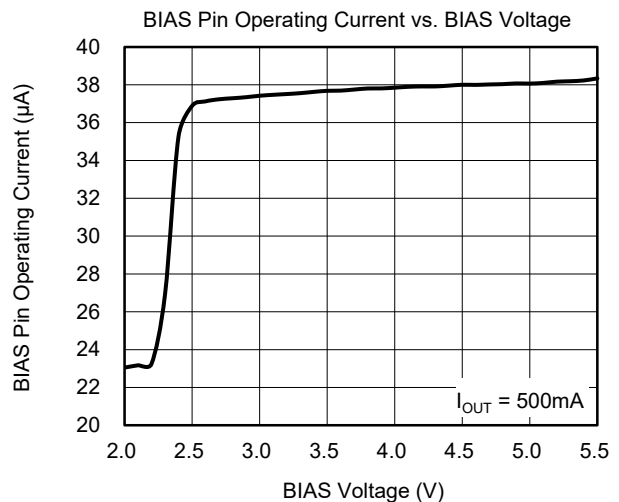
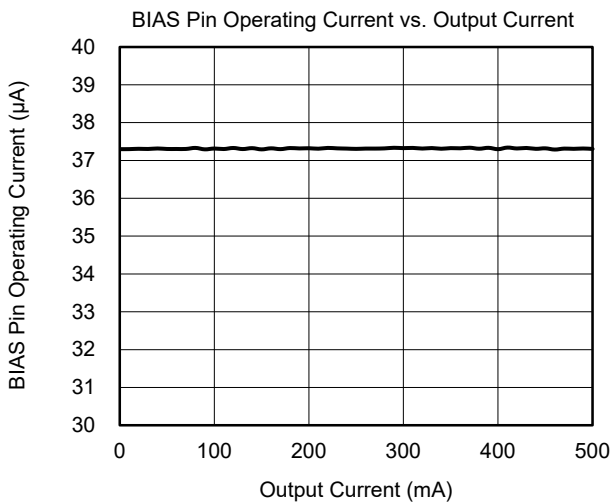
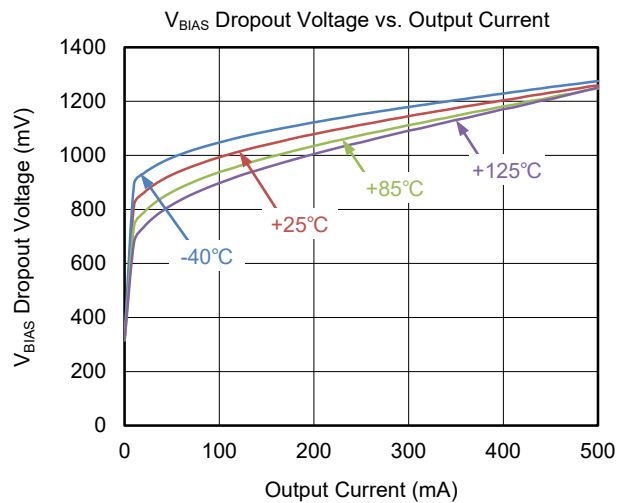
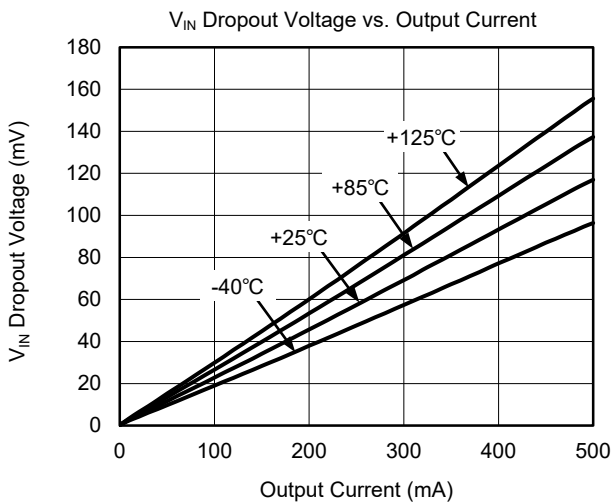
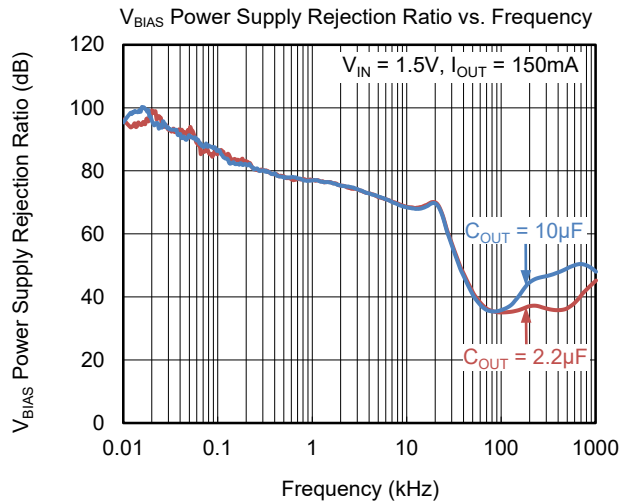
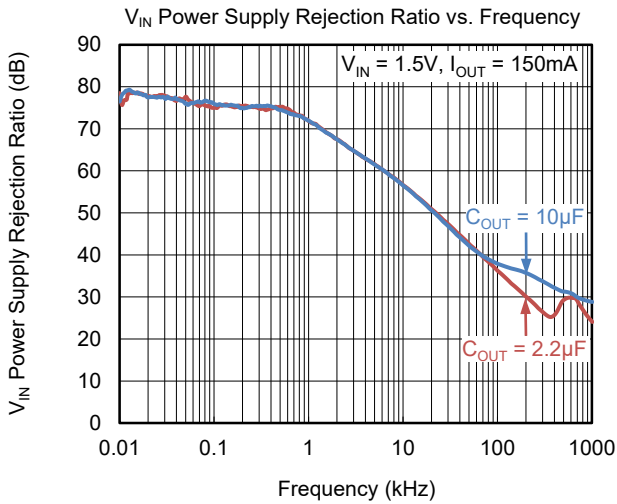

TYPICAL PERFORMANCE CHARACTERISTICS (continued)

$T_A = +25^\circ\text{C}$, $V_{IN} = 1.3\text{V}$, $V_{EN} = V_{BIAS} = 2.7\text{V}$, $V_{OUT(NOM)} = 1.0\text{V}$, $C_{IN} = 1\mu\text{F}$, $C_{BIAS} = 0.1\mu\text{F}$, $C_{OUT} = 2.2\mu\text{F}$, unless otherwise noted.

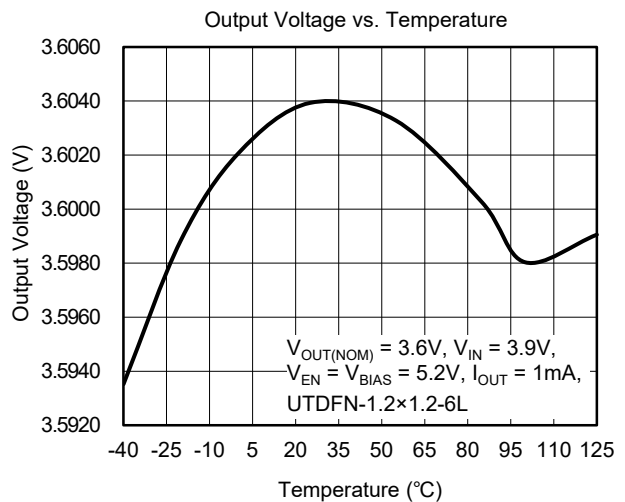
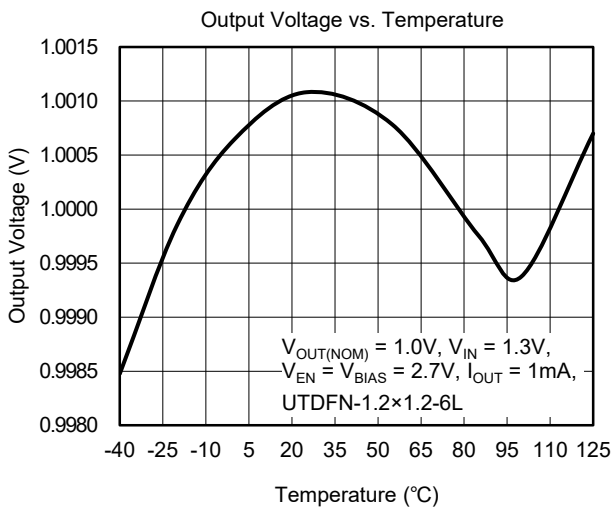
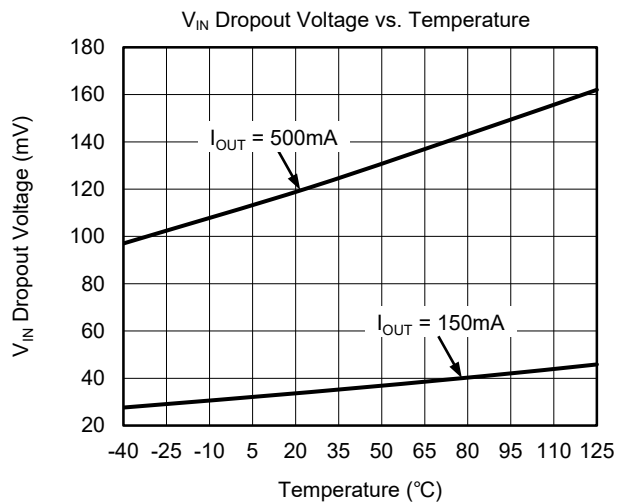
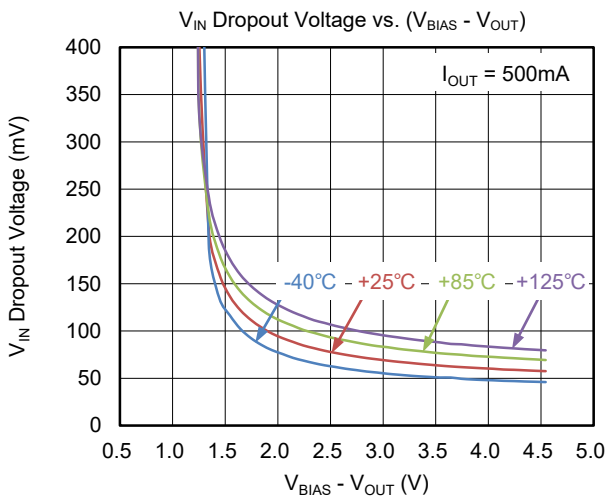
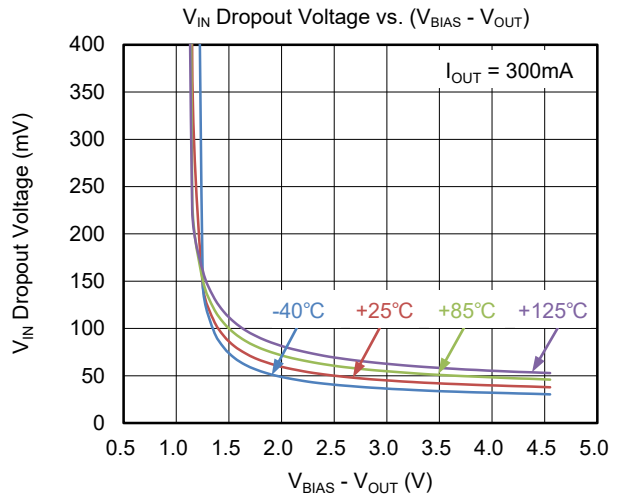
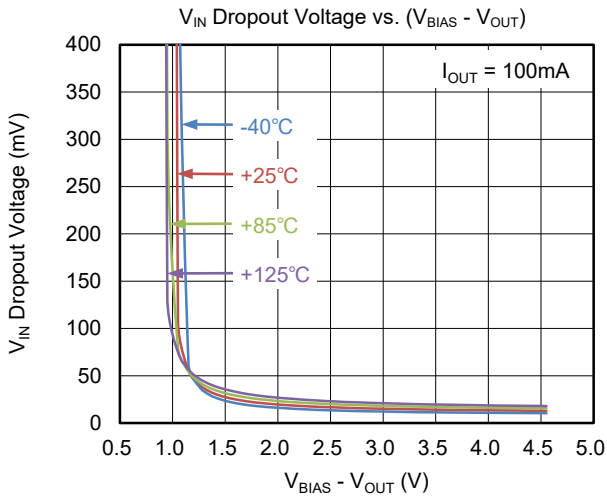

FUNCTIONAL BLOCK DIAGRAM

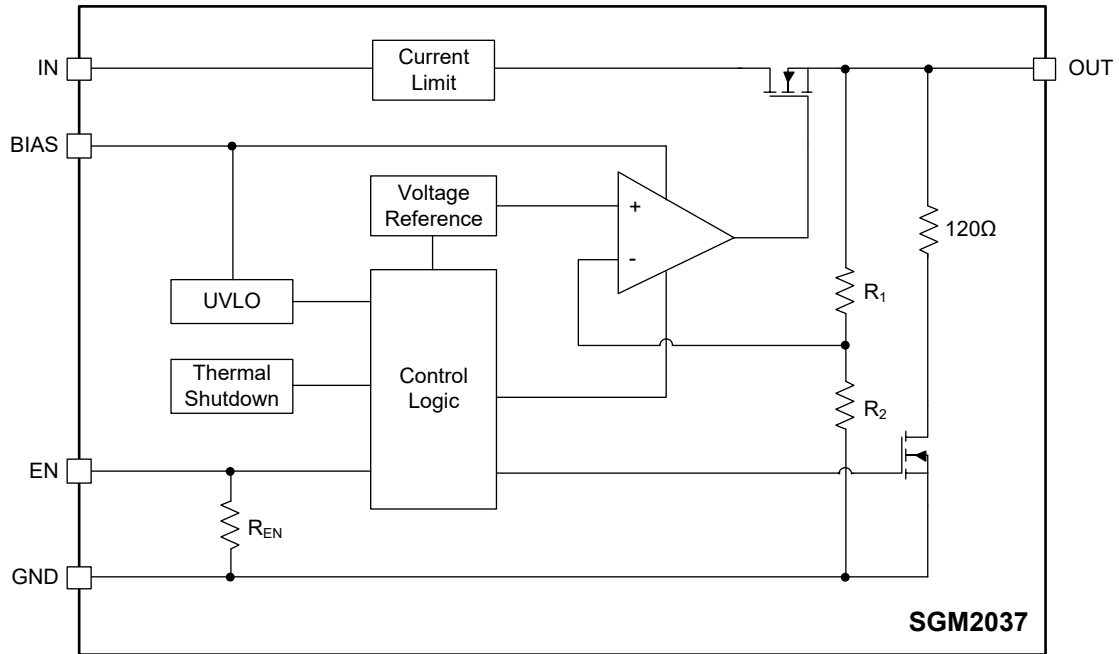

Figure 3. Fixed Version Block Diagram

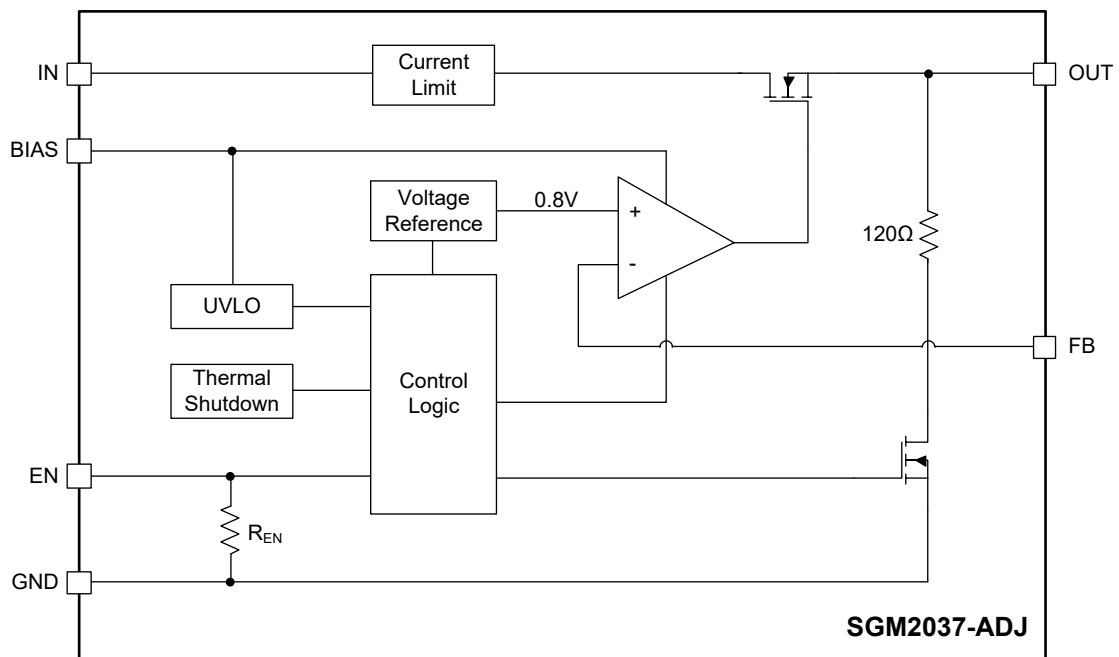

Figure 4. Adjustable Version Block Diagram

APPLICATION INFORMATION

The SGM2037 is a low noise high performance LDO with fast transient response. It consumes only 37µA (TYP) quiescent current and provides 500mA output current. The SGM2037 provides protection functions for output overload, output short-circuit condition and overheating.

The SGM2037 is suitable for applications which need noise sensitive circuit such as battery-powered equipment and smartphones.

Input Capacitor Selection (C_{IN})

The input decoupling capacitor is necessary to be connected as close as possible to the IN pin for ensuring the device stability. A 1µF or larger X7R or X5R ceramic capacitor is selected to get good dynamic performance.

When V_{IN} is required to provide large current instantaneously, a large effective input capacitor is required. Multiple input capacitors can limit the input tracking inductance. Adding more input capacitors is available to restrict the ringing and to keep it below the device absolute maximum ratings.

Output Capacitor Selection (C_{OUT})

The output decoupling capacitor should be located as close as possible to the OUT pin. A 1µF or larger X7R or X5R ceramic capacitor is selected to get good dynamic performance. The minimum effective capacitance of C_{OUT} that SGM2037 can remain stable is 1µF. For ceramic capacitor, temperature, DC bias and package size will change the effective capacitance, so enough margin of C_{OUT} must be considered in design. Larger capacitance and lower ESR C_{OUT} will help improve the load transient response and increase the high frequency PSRR.

Enable Operation

The SGM2037 uses the EN pin to enable/disable the device and to deactivate/activate the output automatic discharge function.

When the EN pin voltage is lower than 0.25V, the device is in shutdown state. There is no current flowing from IN pin to OUT pin. In this state, the automatic discharge transistor is active to discharge the output voltage through a 120Ω (TYP) resistor.

When the EN pin voltage is higher than 1.2V, the device is in active state. The input voltage is regulated to the output voltage and the automatic discharge transistor is turned off.

Adjustable Regulator

The output voltage of the SGM2037-ADJ can be adjusted from 0.8V to 3.6V. The FB pin will be connected to two external resistors as shown in Figure 5. The output voltage is determined by the following equation:

$$V_{OUT} = V_{FB} \times \left(1 + \frac{R_1}{R_2} \right) \quad (1)$$

where:

V_{OUT} is output voltage and V_{FB} is the internal voltage reference, V_{FB} = 0.8V. Choose R₂ = 40kΩ to maintain a 20µA minimum load.

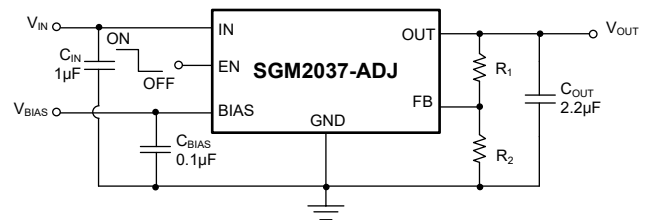

Figure 5. Adjustable Output Voltage Application

Dropout Voltage

The SGM2037 specifies two dropout voltages because there are two power supplies V_{IN} and V_{BIAS} and one V_{OUT} regulator output. V_{IN} dropout voltage is defined as the difference between V_{IN} and V_{OUT} when V_{OUT} falls 5% below V_{OUT(NOM)}. When the output voltage is lower than 1.5V, V_{BIAS} dropout voltage is not applicable because the minimum bias operating voltage is 2.5V.

When V_{OUT} begins to decrease and V_{BIAS} is high enough, the V_{IN} dropout voltage equals to V_{IN} - V_{OUT}. V_{BIAS} dropout voltage refers to V_{BIAS} - V_{OUT} when the IN and BIAS pins are connected together and V_{OUT} begins to decrease.

Output Current Limit and Short-Circuit Protection

When an overload event happens, the output current is internally limited to 670mA (TYP). When the OUT pin is shorted to ground, the short-circuit protection will limit the output current to 340mA (TYP).

APPLICATION INFORMATION (continued)

Thermal Shutdown

The SGM2037 can detect the temperature of die. When the die temperature exceeds the threshold value of thermal shutdown, the SGM2037 will be in shutdown state and it will remain in this state until the die temperature decreases to +140°C.

Power Dissipation (P_D)

Thermal protection limits power dissipation in the SGM2037. When power dissipation on pass element ($P_D = (V_{IN} - V_{OUT}) \times I_{OUT}$) is too much and the operating junction temperature exceeds +160°C, the OTP circuit starts the thermal shutdown function and turns the pass element off.

Therefore, thermal analysis for the chosen application is important to guarantee reliable performance over all conditions. To guarantee reliable operation, the junction temperature of the SGM2037 must not exceed 125°C.

The maximum allowable power dissipation depends on the thermal resistance of the IC package, the PCB layout, the rate of surrounding airflow, and the difference between the junction temperature and ambient temperature. The maximum power dissipation can be approximated using the following equation:

$$P_{D(MAX)} = (T_{J(MAX)} - T_A) / \theta_{JA} \quad (2)$$

where $T_{J(MAX)}$ is the maximum junction temperature, T_A is the ambient temperature, and θ_{JA} is the junction -to-ambient thermal resistance.

Negatively Biased Output

When the output voltage is negative, the chip may not start up due to parasitic effects. Ensure that the output is greater than -0.3V under all conditions. If negatively biased output is excessive and expected in the application, a Schottky diode can be added between the OUT pin and GND pin.

Reverse Current Protection

The NMOS power transistor has an inherent body diode, this body diode will be forward biased when $V_{OUT} > V_{IN}$. When $V_{OUT} > V_{IN}$, the reverse current flowing from the OUT pin to the IN pin will damage the SGM2037. If $V_{OUT} > (V_{IN} + 0.3V)$ is expected in the application, one external Schottky diode will be added between the OUT pin and IN pin to protect the SGM2037.

TYPICAL APPLICATION CIRCUIT

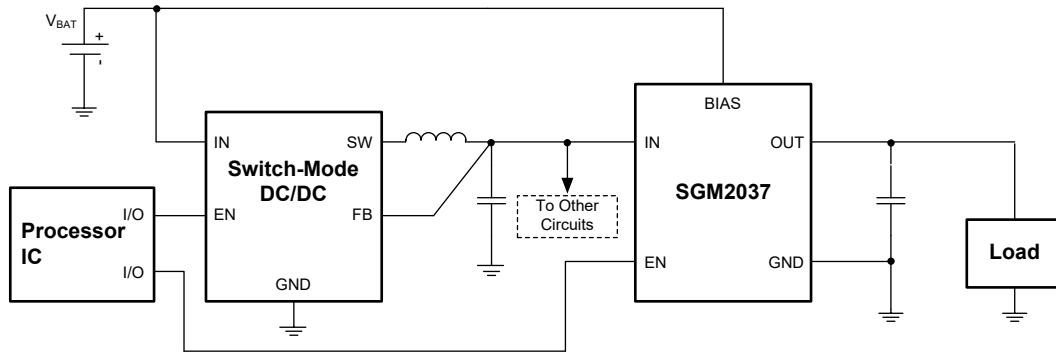

Figure 6. Used as DC/DC Post Regulator

REVISION HISTORY

NOTE: Page numbers for previous revisions may differ from page numbers in the current version.

Changes from Original (SEPTEMBER 2018) to REV.A	Page
Changed from product preview to production data	All

PACKAGE OUTLINE DIMENSIONS

SOT-23-5

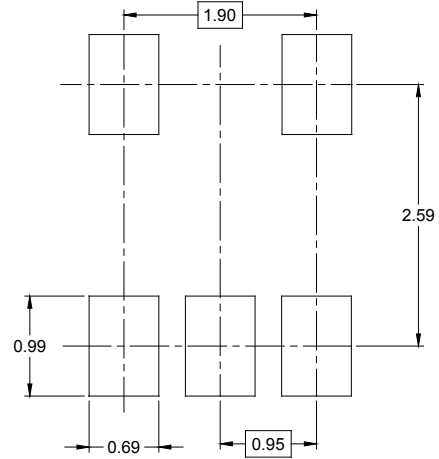
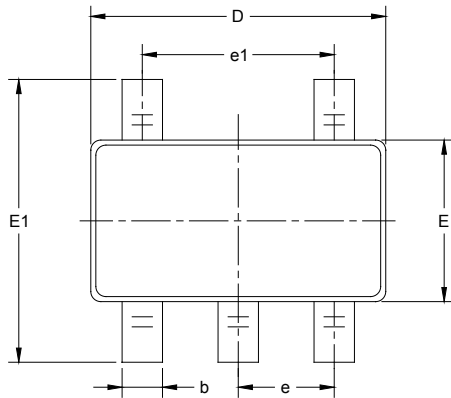

RECOMMENDED LAND PATTERN (Unit: mm)

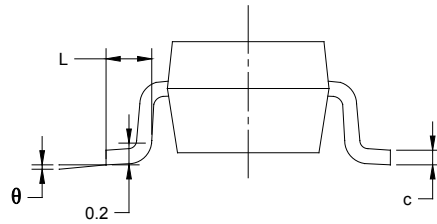
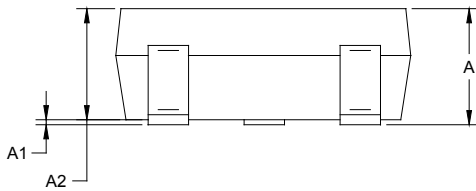

Symbol	Dimensions In Millimeters		Dimensions In Inches	
	MIN	MAX	MIN	MAX
A	1.050	1.250	0.041	0.049
A1	0.000	0.100	0.000	0.004
A2	1.050	1.150	0.041	0.045
b	0.300	0.500	0.012	0.020
c	0.100	0.200	0.004	0.008
D	2.820	3.020	0.111	0.119
E	1.500	1.700	0.059	0.067
E1	2.650	2.950	0.104	0.116
e	0.950 BSC		0.037 BSC	
e1	1.900 BSC		0.075 BSC	
L	0.300	0.600	0.012	0.024
θ	0°	8°	0°	8°

PACKAGE OUTLINE DIMENSIONS

SOT-23-6

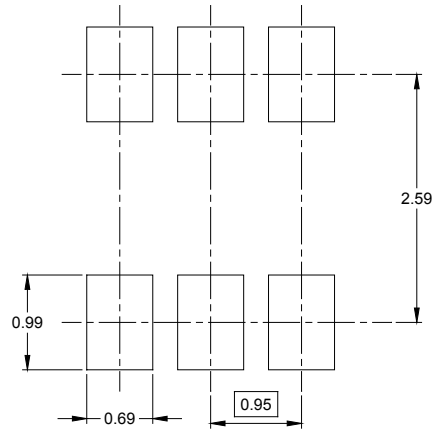
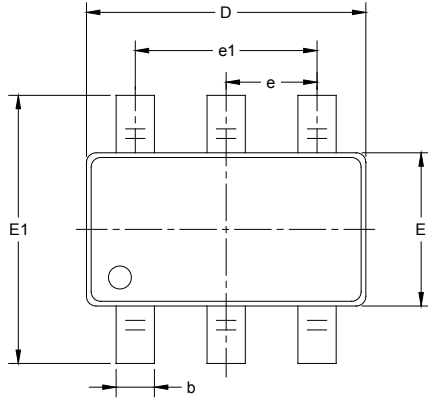

RECOMMENDED LAND PATTERN (Unit: mm)

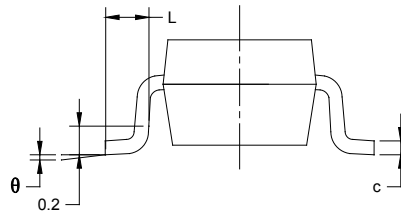
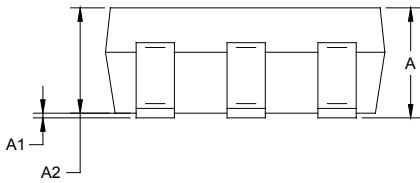

Symbol	Dimensions In Millimeters		Dimensions In Inches	
	MIN	MAX	MIN	MAX
A	1.050	1.250	0.041	0.049
A1	0.000	0.100	0.000	0.004
A2	1.050	1.150	0.041	0.045
b	0.300	0.500	0.012	0.020
c	0.100	0.200	0.004	0.008
D	2.820	3.020	0.111	0.119
E	1.500	1.700	0.059	0.067
E1	2.650	2.950	0.104	0.116
e	0.950 BSC		0.037 BSC	
e1	1.900 BSC		0.075 BSC	
L	0.300	0.600	0.012	0.024
θ	0°	8°	0°	8°

PACKAGE OUTLINE DIMENSIONS

UTDFN-1.2x1.2-6L

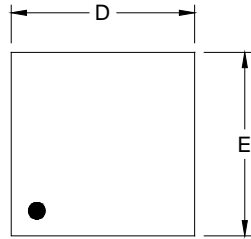

TOP VIEW

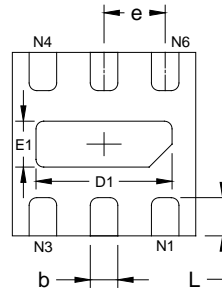

BOTTOM VIEW

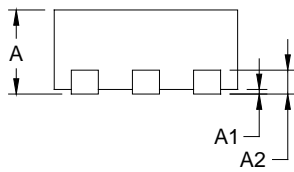

SIDE VIEW

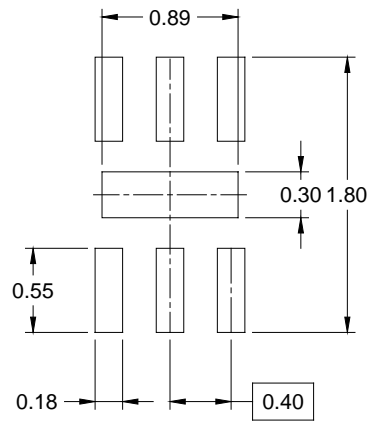

RECOMMENDED LAND PATTERN (Unit: mm)

Symbol	Dimensions In Millimeters		
	MIN	MOD	MAX
A	0.500	0.550	0.600
A1			0.050
A2	0.152 REF		
e	0.400 BSC		
D	1.150	1.200	1.250
E	1.150	1.200	1.250
D1	0.840	0.890	0.940
E1	0.250	0.300	0.350
b	0.130	0.180	0.230
L	0.200	0.250	0.300

PACKAGE INFORMATION

TAPE AND REEL INFORMATION

REEL DIMENSIONS

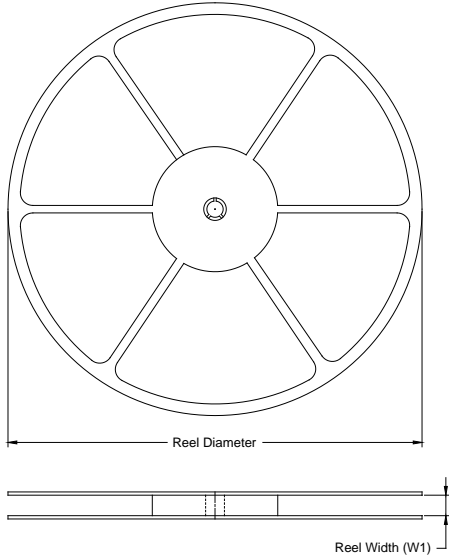

TAPE DIMENSIONS

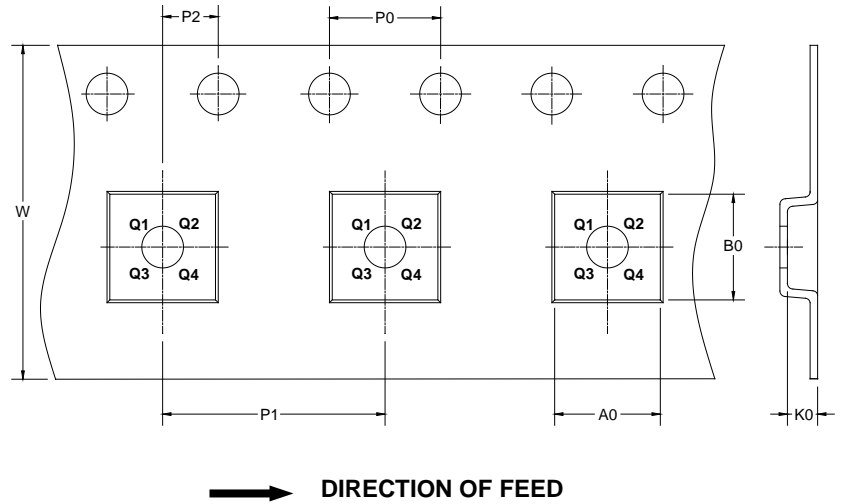

NOTE: The picture is only for reference. Please make the object as the standard.

KEY PARAMETER LIST OF TAPE AND REEL

Package Type	Reel Diameter	Reel Width W1 (mm)	A0 (mm)	B0 (mm)	K0 (mm)	P0 (mm)	P1 (mm)	P2 (mm)	W (mm)	Pin1 Quadrant
SOT-23-5	7"	9.5	3.20	3.20	1.40	4.0	4.0	2.0	8.0	Q3
SOT-23-6	7"	9.5	3.17	3.23	1.37	4.0	4.0	2.0	8.0	Q3
UTDFN-1.2x1.2-6L	7"	9.0	1.35	1.35	0.73	4.0	4.0	2.0	8.0	Q1

DD0001

PACKAGE INFORMATION

CARTON BOX DIMENSIONS

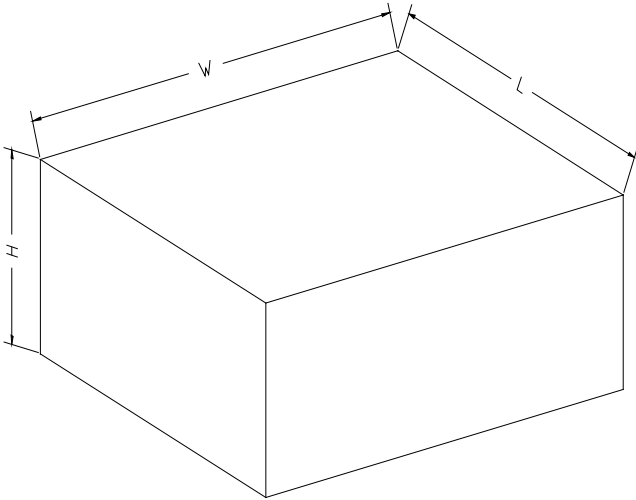

NOTE: The picture is only for reference. Please make the object as the standard.

KEY PARAMETER LIST OF CARTON BOX

Reel Type	Length (mm)	Width (mm)	Height (mm)	Pizza/Carton
7" (Option)	368	227	224	8
7"	442	410	224	18

DP0002

单击下面可查看定价，库存，交付和生命周期等信息

[>>SGMICRO\(圣邦微电子\)](#)