

GENERAL DESCRIPTION

The SGM3141B is a current-regulated buck/boost charge pump LED driver capable of driving 700mA output current. It is ideal for powering high brightness LEDs for camera flash applications. The SGM3141B has 1×/2× operation mode to control the output current for flash and torch modes. Both flash and torch modes can be used continuously until thermal shutdown occurs.

The supply voltage operates from 2.7V to 5.5V and is well suited for various applications powered by a 1-cell Li-Ion battery, as well as 3-cell or 4-cell NiCd, NiMH or Alkaline batteries. The SGM3141B automatically converts between boost and buck modes. Therefore, it ensures that LED current cannot be restricted by the forward voltage. High switching frequency makes it easy to use tiny components. Small 0603 current sense resistors can be used due to the low FB reference voltage.

The SGM3141B provides very low shutdown current and soft-start function. Built-in soft-start circuitry avoids excessive inrush current during startup. The SGM3141B also includes a comprehensive set of protection features such as over-voltage protection, over-current protection and thermal shutdown.

The SGM3141B is available in a Green TDFN-3×3-10L package and is specified over an ambient temperature range of -40°C to +85°C.

TYPICAL APPLICATION

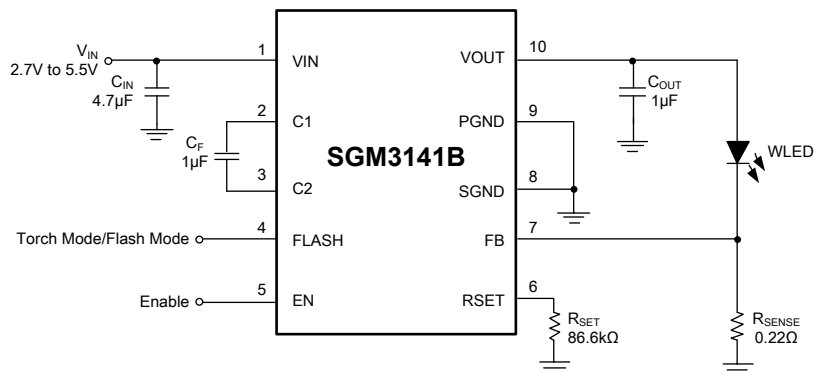

Figure 1. Typical Application Circuit

FEATURES

- Input Voltage Range: 2.7V to 5.5V
- Up to 700mA Output Current
- Up to 90% Efficiency in Torch Mode
- Programmable Flash Current
- Automatic 1× and 2× Modes for High Efficiency
- No External Inductors
- High Switching Frequency: 2.2MHz
- Low Reference for Low Loss Sensing: 47mV
- Less than 1µA Shutdown Current
- Automatic Soft-Start for Reducing Inrush Current
- Low Input and Output Ripple and Low EMI
- Protection Features
 - ♦ Output Over-Voltage Protection
 - ♦ Over-Current Protection
 - ♦ Thermal Shutdown
- Available in a Green TDFN-3×3-10L Package

APPLICATIONS

- White LED Torch or Flash for Mobile Phones, Camcorders and DSCs
- Generic Lighting, Strobe and Flash Applications
- White LED Backlighting
- General Purpose High Current Boost

PACKAGE/ORDERING INFORMATION

MODEL	PACKAGE DESCRIPTION	SPECIFIED TEMPERATURE RANGE	ORDERING NUMBER	PACKAGE MARKING	PACKING OPTION
SGM3141B	TDFN-3×3-10L	-40°C to +85°C	SGM3141BYD10G/TR	SGM 3141BD XXXXX	Tape and Reel, 3000

MARKING INFORMATION

NOTE: XXXXX = Date Code and Vendor Code.

XXXXX

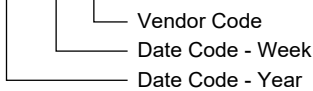

Green (RoHS & HSF): SG Micro Corp defines "Green" to mean Pb-Free (RoHS compatible) and free of halogen substances. If you have additional comments or questions, please contact your SGMICRO representative directly.

ABSOLUTE MAXIMUM RATINGS

V _{IN} , V _{OUT} , C2.....	-0.3V to 6V
EN, C1, FLASH, FB, RSET Pins.....	-0.3V to V _{IN} + 0.3V
Output Current Pulse (Flash).....	1A
Output Current Continuous (Torch).....	0.4A
Package Thermal Resistance	
TDFN-3×3-10L, θ _{JA}	57°C/W
Operating Temperature Range.....	-40°C to +85°C
Junction Temperature.....	+150°C
Storage Temperature Range.....	-40°C to +150°C
Lead Temperature (Soldering, 10s).....	+260°C
ESD Susceptibility	
HBM (EN Pin).....	1000V
HBM (All Other Pins).....	2000V
MM.....	200V

OVERSTRESS CAUTION

Stresses beyond those listed in Absolute Maximum Ratings may cause permanent damage to the device. Exposure to absolute maximum rating conditions for extended periods may affect reliability. Functional operation of the device at any conditions beyond those indicated in the Recommended Operating Conditions section is not implied.

ESD SENSITIVITY CAUTION

This integrated circuit can be damaged if ESD protections are not considered carefully. SGMICRO recommends that all integrated circuits be handled with appropriate precautions. Failure to observe proper handling and installation procedures can cause damage. ESD damage can range from subtle performance degradation to complete device failure. Precision integrated circuits may be more susceptible to damage because even small parametric changes could cause the device not to meet the published specifications.

DISCLAIMER

SG Micro Corp reserves the right to make any change in circuit design, or specifications without prior notice.

PIN CONFIGURATION

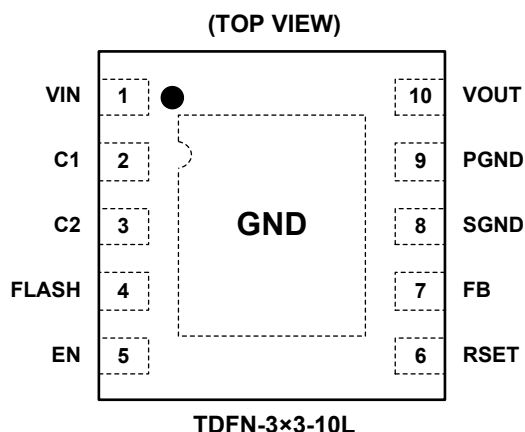

PIN DESCRIPTION

PIN	NAME	FUNCTION
1	VIN	Charge Pump Input Voltage. Decouple with a 4.7 μ F or 10 μ F ceramic capacitor close to the device.
2	C1	Positive Terminal of the Flying Capacitor. Connect a 1 μ F ceramic capacitor close to the device.
3	C2	Negative Terminal of the Flying Capacitor. Connect a 1 μ F ceramic capacitor close to the device.
4	FLASH	Logic Input to Toggle Operation between Flash and Torch Modes. In torch mode, FB is regulated to the internal 47mV reference. In flash mode, FB reference voltage (V_{FB}) can be set by R _{SET} resistor. Choose the external current sense resistor (R _{SENSE}) according to desired current in either torch mode or flash mode.
5	EN	Shutdown Control Input. Pull it high to VIN for normal operation. Pull it Low to ground for shutdown. In normal operation, it is recommended to connect to VIN only after V _{IN} has settled when the VIN ramping up is slow.
6	RSET	RSET Pin. Connect a resistor from this pin to ground. When in Flash mode (FLASH = High), this resistor sets the FB regulation voltage by the following equation: $V_{FB} = (1.26V/R_{SET}) \times 10.2k\Omega.$
7	FB	Feedback Input for Current. Connect the current sense resistor from FB to GND.
8	SGND	Internal Ground Pin. Control circuitry returns current to this pin.
9	PGND	Power Ground Pin. Flying capacitor current returns through this pin.
10	VOUT	Charge Pump Output Voltage. Decouple with at least 1 μ F external capacitor. If a larger capacitor is used, the output ripple is smaller.
Exposed Pad	GND	Exposed Pad. It should be soldered to PCB board and connected to GND.

ELECTRICAL CHARACTERISTICS

($V_{IN} = 3.6V$, $C_{IN} = 4.7\mu F$, $C_{OUT} = C_F = 1\mu F$, $V_{SHDN} = V_{IN}$, Full = $-40^{\circ}C$ to $+85^{\circ}C$, typical values are at $T_A = +25^{\circ}C$, unless otherwise noted.)

PARAMETER	SYMBOL	CONDITIONS	TEMP	MIN	TYP	MAX	UNITS
Input Supply Voltage	V_{IN}		Full	2.7		5.5	V
Quiescent Current	I_Q	$V_{IN} = 2.7V$ to $5.5V$, FLASH = $0V$, $I_{LOAD} = 100\mu A$	Full		0.3	3	mA
		FLASH = V_{IN} , 2× Mode			2		
Shutdown Current	I_{SHDN}	$V_{EN} = 0V$, $V_{IN} = 5.5V$				1	μA
Oscillator Frequency					2.2		MHz
Charge Pump Equivalent Resistance (2× Mode)					5		Ω
Charge Pump Equivalent Resistance (1× Mode)					0.6	0.8	Ω
FB Reference Voltage	V_{FB}	FLASH = V_{IN} , $R_{SET} = 86.6k\Omega$	Full	131	150	165	mV
		FLASH = GND	Full	38	47	54	
FB Pin Current		$V_{FB} = 0.3V$				1	μA
EN, FLASH Logic Low			Full			0.4	V
EN, FLASH Logic High			Full	1.3			V
EN, FLASH Pin Current			Full			1	μA
V_{OUT} Turn-On Time		$V_{IN} = 3.6V$, FB within 90% of regulation			250		μs
Thermal Shutdown Temperature					145		$^{\circ}C$

TYPICAL PERFORMANCE CHARACTERISTICS

$C_{IN} = 10\mu F$, $C_{OUT} = 4.7\mu F$, $C_F = 1\mu F$, unless otherwise noted.

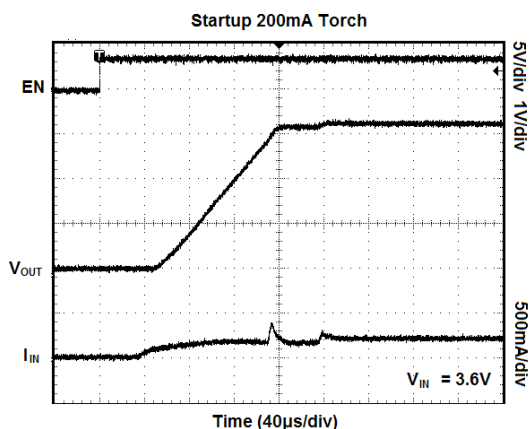
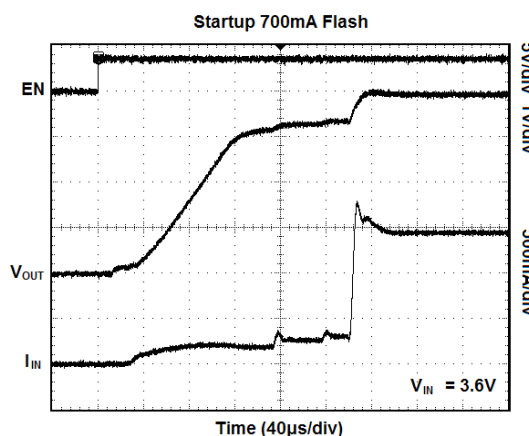
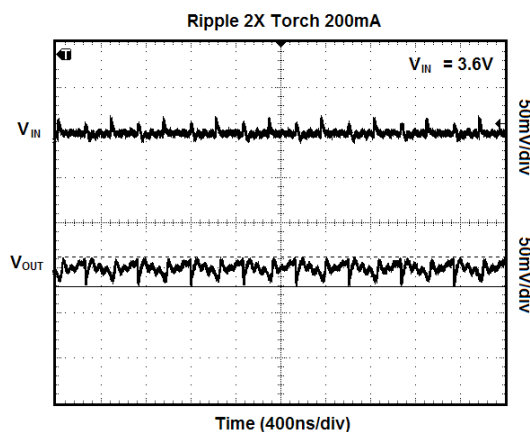
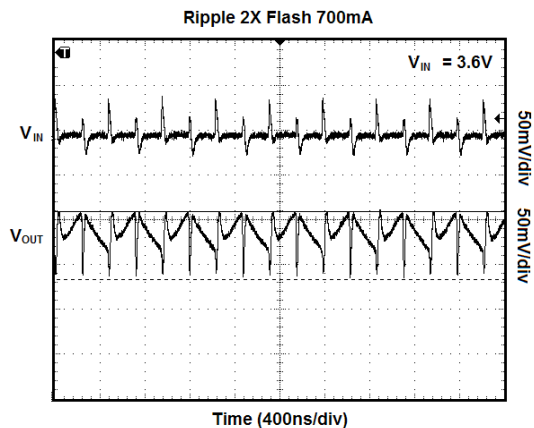
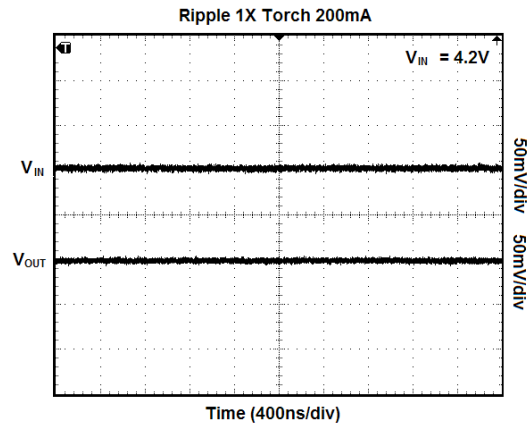
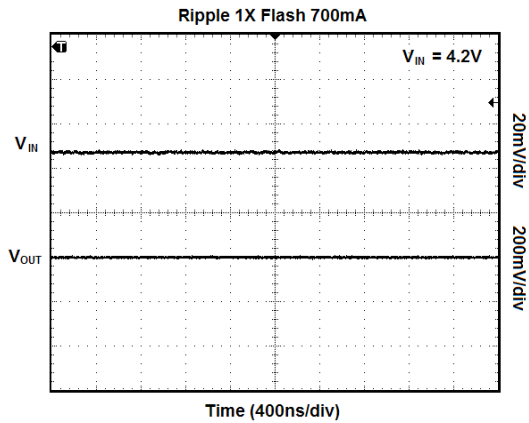

TYPICAL PERFORMANCE CHARACTERISTICS (continued)

C_{IN} = 10μF, C_{OUT} = 4.7μF, C_F = 1μF, unless otherwise noted.

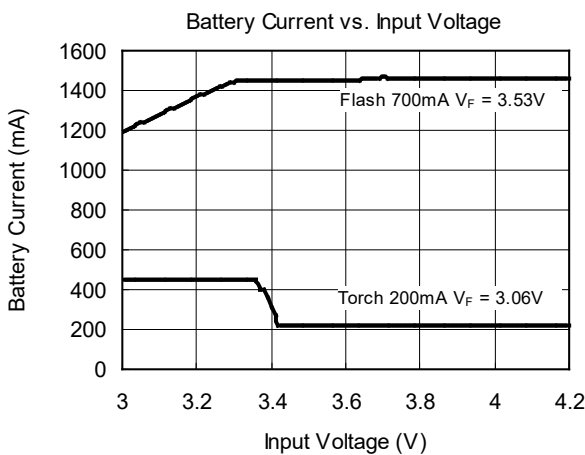
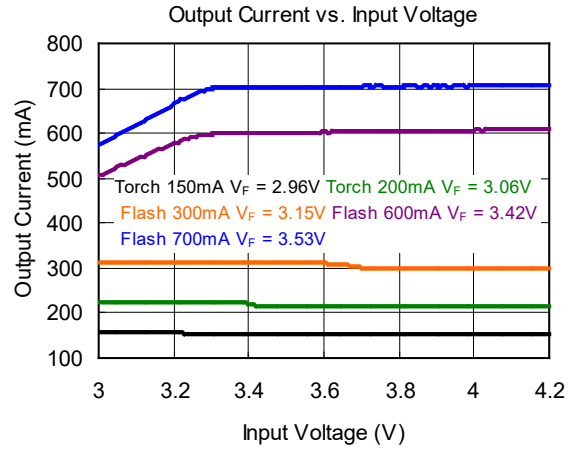
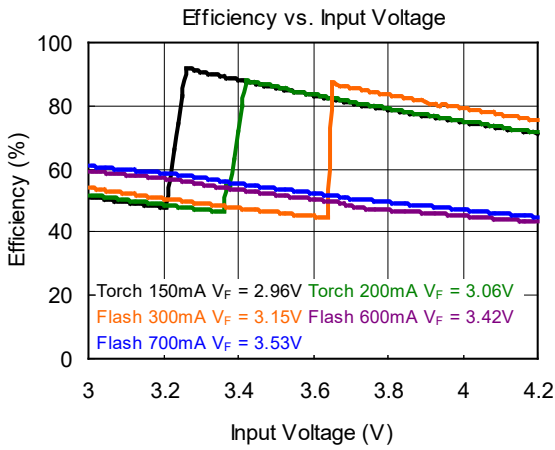
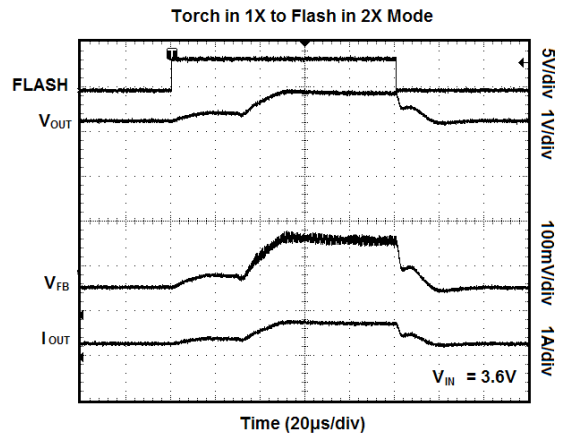
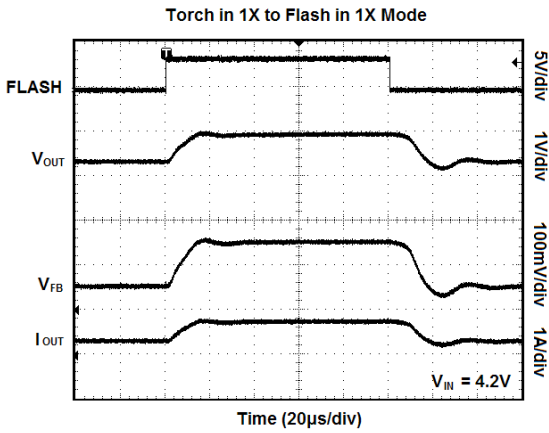

EVALUATION BOARD LAYOUT

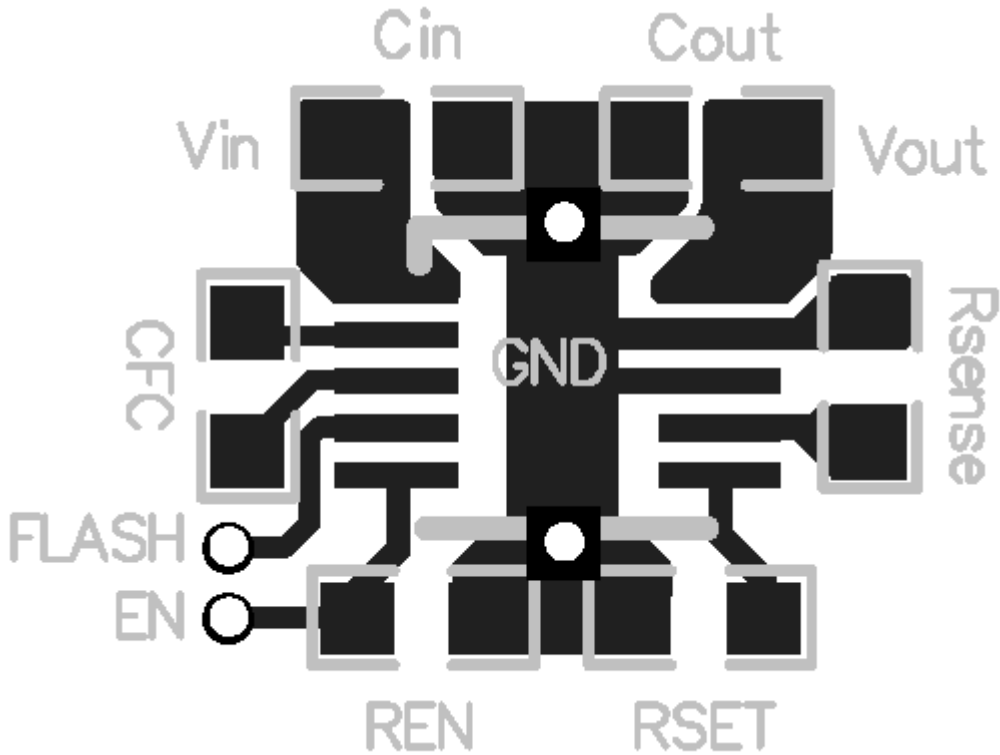

REVISION HISTORY

NOTE: Page numbers for previous revisions may differ from page numbers in the current version.

Changes from Original (SEPTEMBER 2012) to REV.A	Page
Changed from product preview to production data.....	All

PACKAGE OUTLINE DIMENSIONS

TDFN-3x3-10L

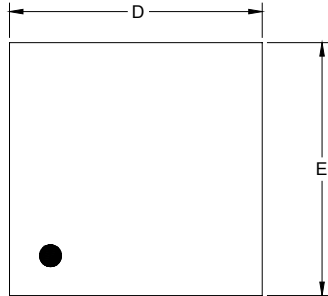

TOP VIEW

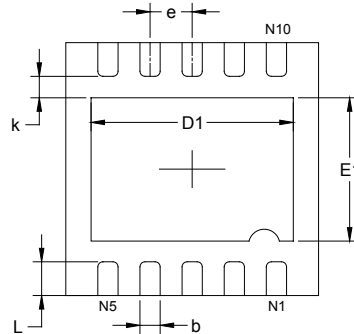

BOTTOM VIEW

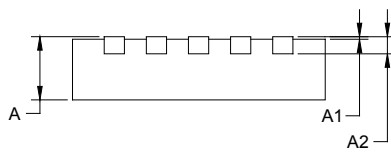

SIDE VIEW

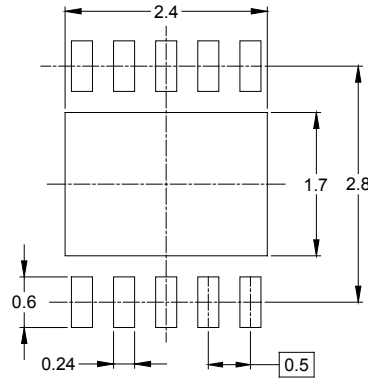

RECOMMENDED LAND PATTERN (Unit: mm)

Symbol	Dimensions In Millimeters		Dimensions In Inches	
	MIN	MAX	MIN	MAX
A	0.700	0.800	0.028	0.031
A1	0.000	0.050	0.000	0.002
A2	0.203 REF		0.008 REF	
D	2.900	3.100	0.114	0.122
D1	2.300	2.600	0.091	0.103
E	2.900	3.100	0.114	0.122
E1	1.500	1.800	0.059	0.071
k	0.200 MIN		0.008 MIN	
b	0.180	0.300	0.007	0.012
e	0.500 TYP		0.020 TYP	
L	0.300	0.500	0.012	0.020

TAPE AND REEL INFORMATION

REEL DIMENSIONS

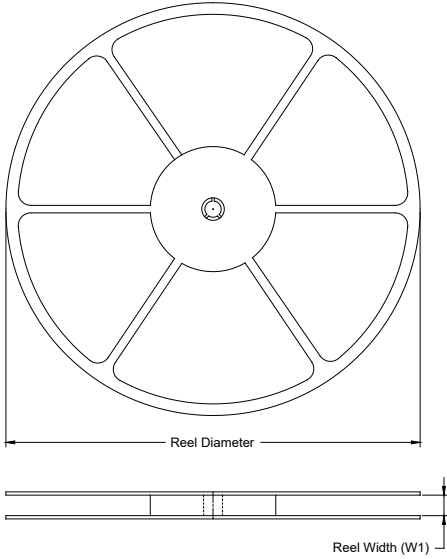

TAPE DIMENSIONS



NOTE: The picture is only for reference. Please make the object as the standard.

KEY PARAMETER LIST OF TAPE AND REEL

Package Type	Reel Diameter	Reel Width W1 (mm)	A0 (mm)	B0 (mm)	K0 (mm)	P0 (mm)	P1 (mm)	P2 (mm)	W (mm)	Pin1 Quadrant
TDFN-3×3-10L	13"	12.4	3.35	3.35	1.13	4.0	8.0	2.0	12.0	Q1

000001

PACKAGE INFORMATION

CARTON BOX DIMENSIONS



NOTE: The picture is only for reference. Please make the object as the standard.

KEY PARAMETER LIST OF CARTON BOX

Reel Type	Length (mm)	Width (mm)	Height (mm)	Pizza/Carton
13"	386	280	370	5

DD0002

单击下面可查看定价，库存，交付和生命周期等信息

[>>SGMICRO\(圣邦微电子\)](#)