



SGM8197xQ Automotive, High-Side Current-Sense Amplifier with Open-Drain Comparator and Reference

GENERAL DESCRIPTION

The SGM8197xQ series is used for high-side current-sense automotive applications with an integrated amplifier output and an open-drain comparator with a 0.6V reference. The device can sense the voltage across a current-sense resistor at common mode voltages from -24V to 105V. There are four different gains for SGM8197xQ series: 10V/V, 20V/V, 50V/V and 100V/V, and the bandwidth reaches 1200kHz for SGM8197A1Q (20V/V).

An open-drain comparator and 0.6V voltage reference are integrated. The 0.6V reference is connected to the inverting input of comparator, and the current trip point can be set with the external voltage at the CMP_{IN} pin. The comparator output can be transparent or latched, depending on whether the \overline{RESET} pin is pulled high or left floating (or grounded).

The operating supply voltage of SGM8197xQ series is from 2.7V to 28V, with a typical supply current of 550 μ A.

The SGM8197xQ series is available in Green SOIC-8 and MSOP-8 packages. It is specified within -40°C to +125°C temperature range.

This device is AEC-Q100 qualified (Automotive Electronics Council (AEC) standard Q100 Grade 1) and it is suitable for automotive applications.

FEATURES

- **AEC-Q100 Qualified for Automotive Applications Device Temperature Grade 1**
 $T_A = -40^\circ\text{C}$ to $+125^\circ\text{C}$
- **Power Supply Range: 2.7V to 28V**
- **Quiescent Current: 550 μ A (TYP)**
- **Choice of Gains:**
 - ♦ **SGM8197A0Q Gain: 10V/V**
 - ♦ **SGM8197A1Q Gain: 20V/V**
 - ♦ **SGM8197A2Q Gain: 50V/V**
 - ♦ **SGM8197A3Q Gain: 100V/V**
- **High Accuracy: 1.4% (MAX) Gain Error**
- **Input Common Mode Voltage Range: -24V to 105V**
- **Bandwidth: 1200kHz (SGM8197A1Q)**
- **Voltage Reference of the Comparator: 0.6V (TYP)**
- **Comparator with an Open-Drain Output**
- **Capability of Latching on the Comparator Output**
- **Available in Green SOIC-8 and MSOP-8 Packages**

APPLICATIONS

AEC-Q100 Grade 1 Applications
Power Management
Notebook Computer
Industrial Current Sensing
Battery Charger
Automotive

Automotive, High-Side Current-Sense Amplifier with Open-Drain Comparator and Reference

SGM8197xQ

PACKAGE/ORDERING INFORMATION

MODEL	PACKAGE DESCRIPTION	SPECIFIED TEMPERATURE RANGE	ORDERING NUMBER	PACKAGE TOP MARKING	PACKING OPTION
SGM8197A0Q (Gain = 10V/V)	SOIC-8	-40°C to +125°C	SGM8197A0QS8G/TR	0CSS8 XXXXX	Tape and Reel, 4000
	MSOP-8	-40°C to +125°C	SGM8197A0QMS8G/TR	0CRMS8 XXXXX	Tape and Reel, 4000
SGM8197A1Q (Gain = 20V/V)	SOIC-8	-40°C to +125°C	SGM8197A1QS8G/TR	09AS8 XXXXX	Tape and Reel, 4000
	MSOP-8	-40°C to +125°C	SGM8197A1QMS8G/TR	09BMS8 XXXXX	Tape and Reel, 4000
SGM8197A2Q (Gain = 50V/V)	SOIC-8	-40°C to +125°C	SGM8197A2QS8G/TR	0CTS8 XXXXX	Tape and Reel, 4000
	MSOP-8	-40°C to +125°C	SGM8197A2QMS8G/TR	0CQMS8 XXXXX	Tape and Reel, 4000
SGM8197A3Q (Gain = 100V/V)	SOIC-8	-40°C to +125°C	SGM8197A3QS8G/TR	0CUS8 XXXXX	Tape and Reel, 4000
	MSOP-8	-40°C to +125°C	SGM8197A3QMS8G/TR	0CPMS8 XXXXX	Tape and Reel, 4000

MARKING INFORMATION

NOTE: XXXXX = Date Code, Trace Code and Vendor Code.

XXXXX

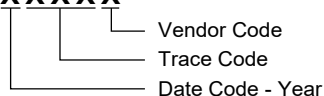

Green (RoHS & HSF): SG Micro Corp defines "Green" to mean Pb-Free (RoHS compatible) and free of halogen substances. If you have additional comments or questions, please contact your SGMICRO representative directly.

ABSOLUTE MAXIMUM RATINGS

Supply Voltage, V_S	GND to 28.5V
Analog Inputs of Current Shunt Monitor, IN+, IN-	
Differential (V_{IN+}) - (V_{IN-}).....	-28.5V to 28.5V
Common Mode ⁽¹⁾	-28V to 110V
Analog Input and Reset Pins of Comparator ⁽¹⁾	
.....	GND - 0.3V to V_S + 0.3V
Analog Output, OUT ⁽¹⁾	GND - 0.3V to V_S + 0.3V
Comparator Output, CMP _{OUT} ⁽¹⁾	GND - 0.3V to 28.5V
Input Current into Any Pin ⁽¹⁾	5mA
Junction Temperature.....	+150°C
Storage Temperature Range.....	-65°C to +150°C
Lead Temperature (Soldering, 10s).....	+260°C
ESD Susceptibility	
HBM.....	2000V
CDM.....	1000V

RECOMMENDED OPERATING CONDITIONS

Input Common Mode Voltage, V_{CM}	-24V to 105V
Operating Power Supply Voltage, V_S	2.7V to 28V
Operating Temperature Range.....	-40°C to +125°C

NOTE: 1. If the current limit of this pin is 5mA, the corresponding voltage may be higher than the ratings.

OVERSTRESS CAUTION

Stresses beyond those listed in Absolute Maximum Ratings may cause permanent damage to the device. Exposure to absolute maximum rating conditions for extended periods may affect reliability. Functional operation of the device at any conditions beyond those indicated in the Recommended Operating Conditions section is not implied.

ESD SENSITIVITY CAUTION

This integrated circuit can be damaged if ESD protections are not considered carefully. SGMICRO recommends that all integrated circuits be handled with appropriate precautions. Failure to observe proper handling and installation procedures can cause damage. ESD damage can range from subtle performance degradation to complete device failure. Precision integrated circuits may be more susceptible to damage because even small parametric changes could cause the device not to meet the published specifications.

DISCLAIMER

SG Micro Corp reserves the right to make any change in circuit design, or specifications without prior notice.

PIN CONFIGURATIONS

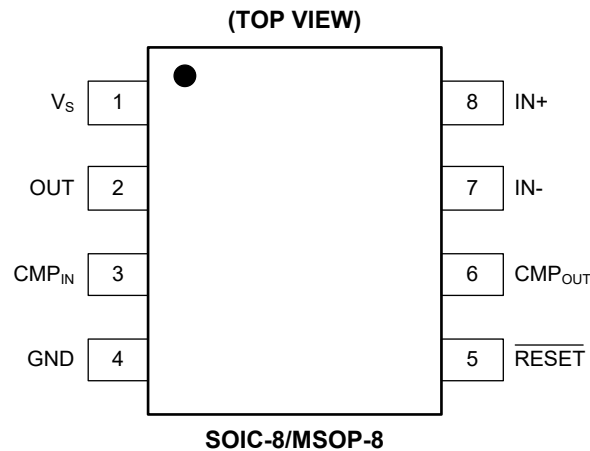

PIN DESCRIPTION

PIN	NAME	I/O	FUNCTION
1	V _s	—	Power Supply.
2	OUT	Analog Output	Output of the Current-Sense Amplifier.
3	CMP _{IN}	Analog Input	Non-Inverting Input of the Comparator.
4	GND	—	Ground.
5	$\overline{\text{RESET}}$	Input	Comparator Working Mode Control. When $\overline{\text{RESET}}$ = "Low" or left open, there is no latching action, and the comparator result appears at CMP _{OUT} pin directly. When $\overline{\text{RESET}}$ = "High", the comparator result is latched at the CMP _{OUT} pin.
6	CMP _{OUT}	Analog Output	Open-Drain Output of the Comparator.
7	IN-	Analog Input	Inverting Input of the Current-Sense Amplifier. Connect to the low-side of the current-sense resistor.
8	IN+	Analog Input	Non-Inverting Input of the Current-Sense Amplifier. Connect to the high-side of the current-sense resistor.

FUNCTIONAL BLOCK DIAGRAM

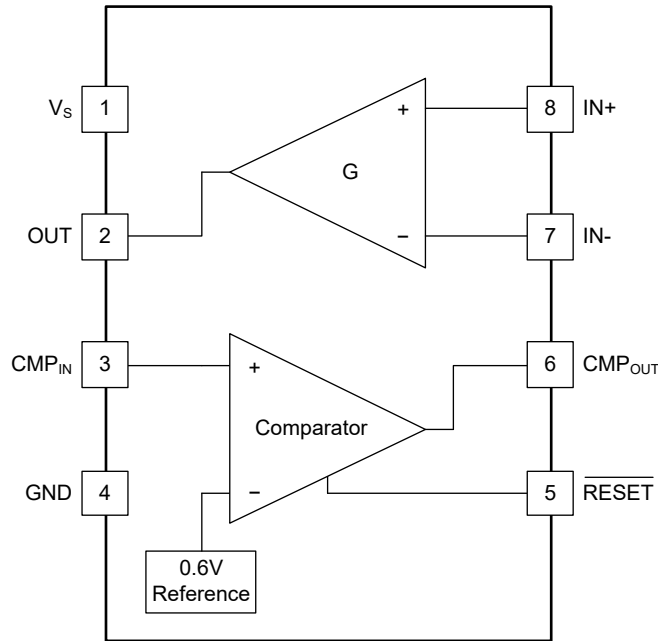

Figure 1. Block Diagram

BASIC SCHEMATIC IN APPLICATION

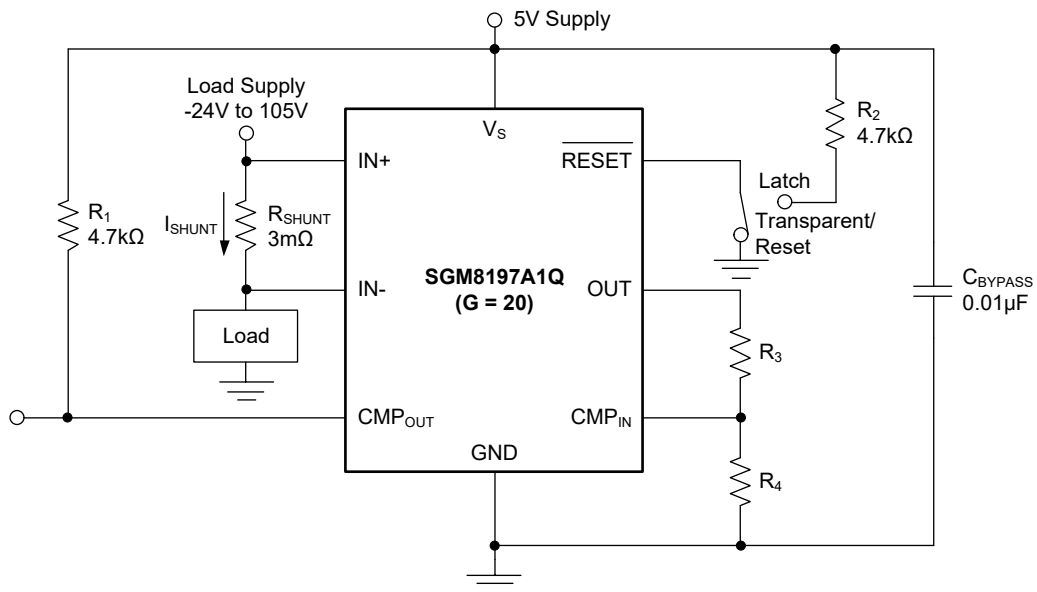

Figure 2. SGM8197A1Q Basic Schematic

Automotive, High-Side Current-Sense Amplifier with Open-Drain Comparator and Reference

SGM8197xQ

ELECTRICAL CHARACTERISTICS

Current-Sense Monitor

($V_S = 12V$, $V_{CM} = 12V$, $V_{SENSE} = 100mV$, $R_L = 10k\Omega$ to GND, $R_{PULL-UP} = 5.1k\Omega$ is between CMP_{OUT} and V_S , and $CMP_{IN} = GND$, Full = $-40^\circ C$ to $+125^\circ C$, typical values are at $T_A = +25^\circ C$, unless otherwise noted.)

PARAMETER	CONDITIONS	TEMP	MIN	TYP	MAX	UNITS
Input Characteristics						
Full-Scale Sense Input Voltage (V_{SENSE})	$V_{SENSE} = V_{IN+} - V_{IN-}$	+25°C			0.3	V
Input Offset Voltage, RTI ⁽¹⁾ (V_{OS})		+25°C		±1.5	±4.0	mV
		Full			±4.5	
Input Bias Current, IN- Pin (I_B)		+25°C		±0.25	±50	nA
		Full			±100	
Input Common Mode Voltage Range (V_{CM})		Full	-24		105	V
Common Mode Rejection Ratio (CMRR)	$V_{IN+} = -24V$ to 105V	Full	82	102		dB
	$V_{IN+} = 12V$ to 105V	Full	100	120		
Power Supply Rejection Ratio, RTI	$V_S = 2.7V$ to 28V, $V_{OUT} = 2V$	+25°C		4.5	55	μV/V
		Full			75	
Output Characteristics						
Output Swing to the Positive Rail	$V_S = 5V$ for SGM8197A0Q, $V_S = 12V$ for SGM8197A1Q/A2Q/A3Q	+25°C		185	240	mV
		Full			400	
Output Swing to GND	$V_{IN-} = 0V$, $V_{IN+} = -0.5V$	+25°C		10	20	mV
		Full			50	
Output Characteristics ($V_{SENSE} = 0mV$) ⁽²⁾						
Output	$V_S = 2.7V$ to 28V, $-24V \leq V_{CM} \leq 0V$, $V_S \leq V_{CM} \leq 105V$	SGM8197A0Q	+25°C		40	mV
		SGM8197A1Q	+25°C		80	
		SGM8197A2Q	+25°C		200	
		SGM8197A3Q	+25°C		400	
		$V_S = 12V$, $1V < V_{CM} < 3V$, $9V < V_{CM} < 11V$	+25°C			2.5
Output Characteristics ($V_{SENSE} \geq 20mV$)						
Gain (G)	SGM8197A0Q	+25°C		10		V/V
	SGM8197A1Q	+25°C		20		
	SGM8197A2Q	+25°C		50		
	SGM8197A3Q	+25°C		100		
Gain Error	$V_{SENSE} = 20mV$ to 100mV	+25°C		±0.3	±1.4	%
		Full			±1.5	
Total Output Error ⁽³⁾	$V_S = 16V$, $V_{SENSE} = 120mV$	+25°C		±0.35	±4.4	%
		Full			±4.8	
Nonlinearity Error ⁽⁴⁾	$V_{SENSE} = 20mV$ to 100mV	+25°C		0.0075		%
Output Impedance ⁽⁵⁾ (R_{OUT})		+25°C		0.2		Ω
Maximum Capacitive Load ⁽⁵⁾	No sustained oscillation	+25°C		10		nF

NOTES:

- The output offset is measured with V_{SENSE} equal to 20mV and 100mV.
- For more information about operation, see Variations of Accuracy Due to V_{SENSE} and V_{CM} section.
- The total output error is affected by gain error and input offset voltage.
- The linearity is defined as a straight line.
- Defined by design.

Automotive, High-Side Current-Sense Amplifier with Open-Drain Comparator and Reference

SGM8197xQ

ELECTRICAL CHARACTERISTICS (continued)

Current-Sense Monitor

($V_S = 12V$, $V_{CM} = 12V$, $V_{SENSE} = 100mV$, $R_L = 10k\Omega$ to GND, $R_{PULL-UP} = 5.1k\Omega$ is between CMP_{OUT} and V_S , and $CMP_{IN} = GND$, Full = $-40^\circ C$ to $+125^\circ C$, typical values are measured at $T_A = +25^\circ C$, unless otherwise noted.)

PARAMETER	CONDITIONS	TEMP	MIN	TYP	MAX	UNITS
Dynamic Performance						
Bandwidth (BW)	$C_L = 5pF$	SGM8197A0Q	+25°C		1600	kHz
		SGM8197A1Q	+25°C		1200	
		SGM8197A2Q	+25°C		800	
		SGM8197A3Q	+25°C		500	
Phase Margin	$C_L < 10nF$	+25°C		40		°
Slew Rate (SR)		+25°C		1.7		V/ μs
Settling Time to 1%	$V_{SENSE} = 10mV$ to $100mV$, $C_L = 5pF$, including output slewing from 1V to 10V	+25°C		4.5		μs
PWM Edge Recovery Settling Time	$-24V \leq V_{CM} \leq 105V$	+25°C		12		μs
Noise, RTI						
Voltage Noise Density		+25°C		38		nV/ \sqrt{Hz}

Automotive, High-Side Current-Sense Amplifier with Open-Drain Comparator and Reference

SGM8197xQ

ELECTRICAL CHARACTERISTICS (continued)

Comparator

($V_S = 12V$, $V_{CM} = 12V$, $V_{SENSE} = 100mV$, $R_L = 10k\Omega$ to GND, $R_{PULL-UP} = 5.1k\Omega$ is between CMP_{OUT} and V_S , and $CMP_{IN} = GND$, Full = $-40^\circ C$ to $+125^\circ C$, typical values are at $T_A = +25^\circ C$, unless otherwise noted.)

PARAMETER	CONDITIONS	TEMP	MIN	TYP	MAX	UNITS
Input Characteristics						
Input Offset Voltage Threshold		+25°C	550	600	650	mV
		Full	545		655	
Input Offset Voltage Hysteresis ⁽¹⁾		+25°C		-11		mV
Input Bias Current, CMP_{IN} Pin		+25°C		± 0.01	± 0.5	nA
		Full			± 1	
Input Voltage Range, CMP_{IN} Pin		+25°C	0		V_S	V
Output Characteristics (Open-Drain)						
Large-Signal Differential Voltage Gain ⁽²⁾	CMP_{OUT} 1V to 4V, $R_L \geq 15k\Omega$ connected to 5V	+25°C		300		V/mV
High-Level Leakage Current ^{(3) (4)} (I_{LKG})	$V_{ID} = 0.4V$, $V_{OH} = V_S$	+25°C		1.5	50	nA
		Full			100	
Low-Level Output Voltage ⁽³⁾ (V_{OL})	$V_{ID} = -0.6V$, $I_{OL} = 2.35mA$	+25°C		170	240	mV
		Full			395	
Dynamic Performance						
Response Time ⁽⁵⁾	R_L to 5V, $C_L = 15pF$, 100mV input step with 5mV overdrive	+25°C		0.3		μs
RESET						
RESET Threshold ⁽⁶⁾		+25°C		1.1		V
Logic Input Impedance		+25°C		2		$M\Omega$
Minimum RESET Pulse Width		+25°C		0.2		μs
RESET Propagation Delay		+25°C		0.2		μs

NOTES:

1. The threshold is defined at the rising edge of the non-inverting input of the comparator. The hysteresis is defined as the difference between the falling and rising edges of the signal on the non-inverting input of the comparator.

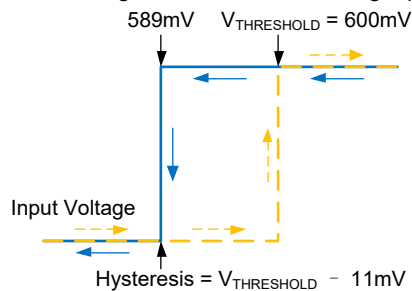

Figure 3. Hysteresis of Comparator

2. Defined by Design.

3. V_{ID} means the differential voltage which occurs at the inverting and non-inverting pin of the comparator.

4. The open-drain output of the comparator can be pulled to 2.7V to 28V, regardless of V_S .

5. The specification of the response time of the comparator is the gap between the output transitioning through 1.4V and the step waveform at the input.

6. There is an internal $2M\Omega$ (TYP) pull-down resistor on the \overline{RESET} input. With the \overline{RESET} pin left open, it will be in the low state, which is the transparent mode of the comparator.

Automotive, High-Side Current-Sense Amplifier with Open-Drain Comparator and Reference

SGM8197xQ

ELECTRICAL CHARACTERISTICS (continued)

General

($V_S = 12V$, $V_{CM} = 12V$, $V_{SENSE} = 100mV$, $R_L = 10k\Omega$ to GND, $R_{PULL-UP} = 5.1k\Omega$ is between CMP_{OUT} and V_S , and $CMP_{IN} = GND$, Full = $-40^\circ C$ to $+125^\circ C$, typical values are at $T_A = +25^\circ C$, unless otherwise noted.)

PARAMETER	CONDITIONS	TEMP	MIN	TYP	MAX	UNITS
Power Supply						
Operating Power Supply (V_S)		+25°C	2.7		28	V
Quiescent Current (I_Q)	$V_{OUT} = 2V$	+25°C		550	850	μA
		Full			1000	
	$V_{SENSE} = 0mV$	+25°C		420	750	
		Full			900	
Comparator Power-On Reset Threshold ⁽¹⁾		+25°C		1.75		V

NOTE:

1. If the \overline{RESET} pin is open or grounded at power up, the internal comparator of the SGM8197xQ series will come up in a defined reset state. For supply voltages lower than 1.75V, the comparator will be in reset. The state of the comparator is defined by the input conditions when the supply voltage is larger than 1.75V. Moreover, if \overline{RESET} is high at power-up, the comparator output will be high and requires a low on the \overline{RESET} pin to reset.

SGM8197xQ Automotive, High-Side Current-Sense Amplifier with Open-Drain Comparator and Reference

TYPICAL PERFORMANCE CHARACTERISTICS

At $T_A = +25^\circ\text{C}$, $V_S = 12\text{V}$, $V_{IN+} = 12\text{V}$, and $V_{SENSE} = 100\text{mV}$, unless otherwise noted.

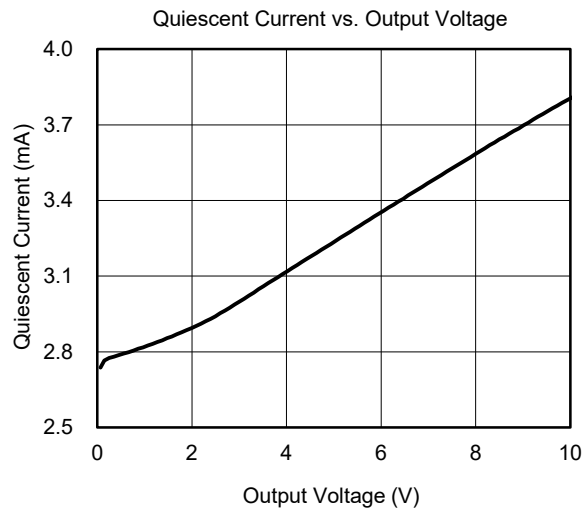
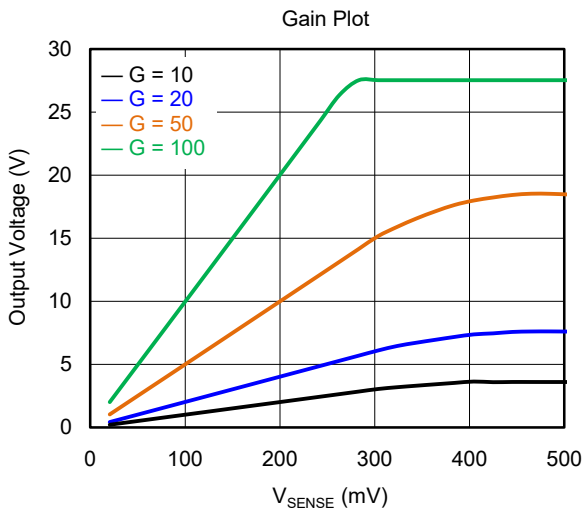
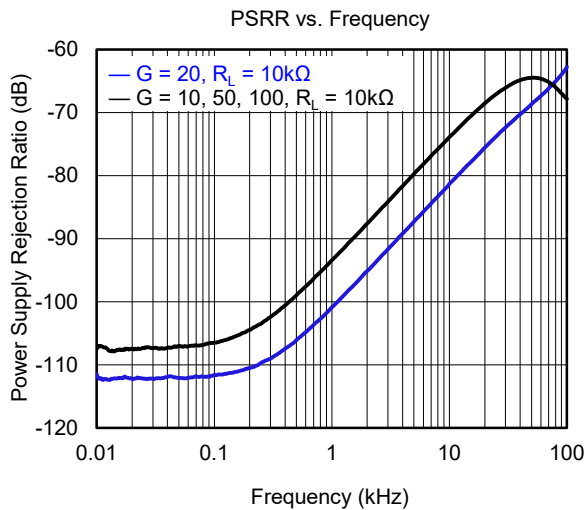
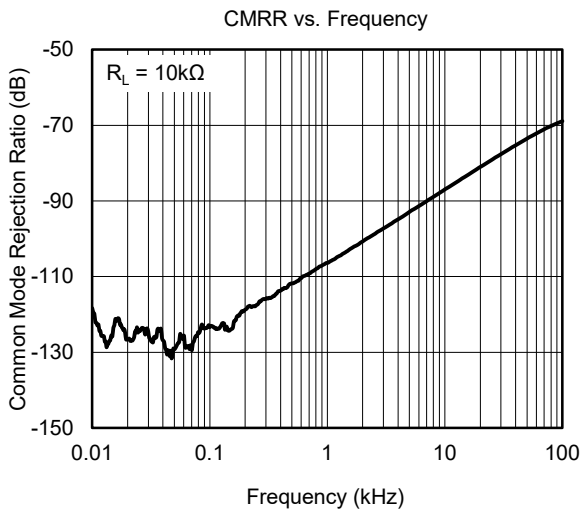
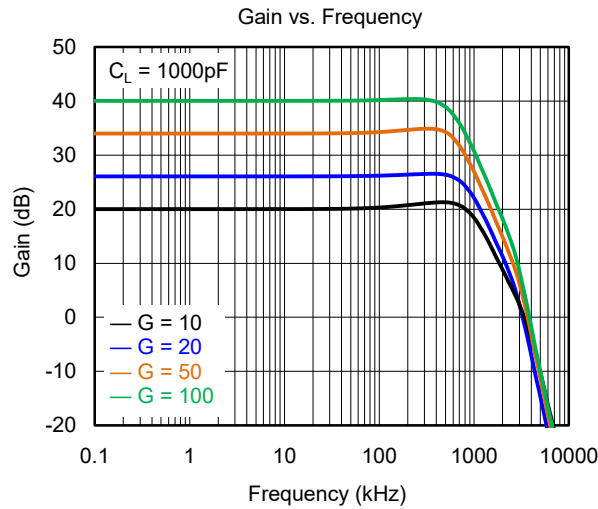
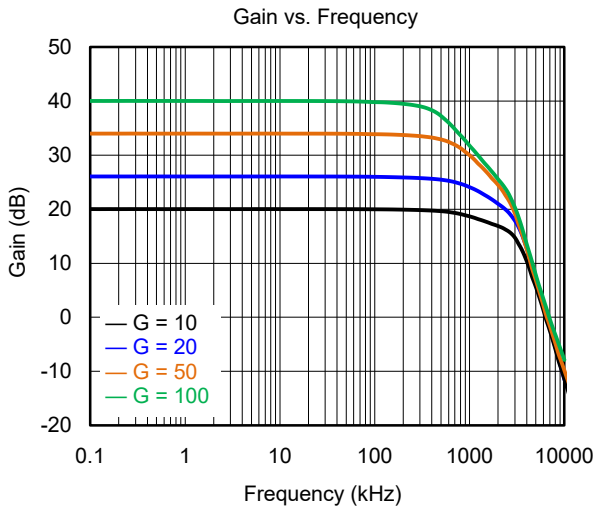

Automotive, High-Side Current-Sense Amplifier with Open-Drain Comparators and Reference

SGM8197xQ

TYPICAL PERFORMANCE CHARACTERISTICS (continued)

At $T_A = +25^\circ\text{C}$, $V_S = 12\text{V}$, $V_{IN+} = 12\text{V}$, and $V_{SENSE} = 100\text{mV}$, unless otherwise noted.

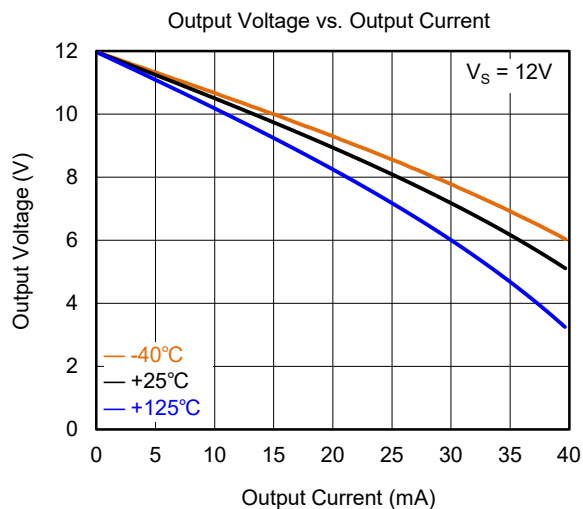
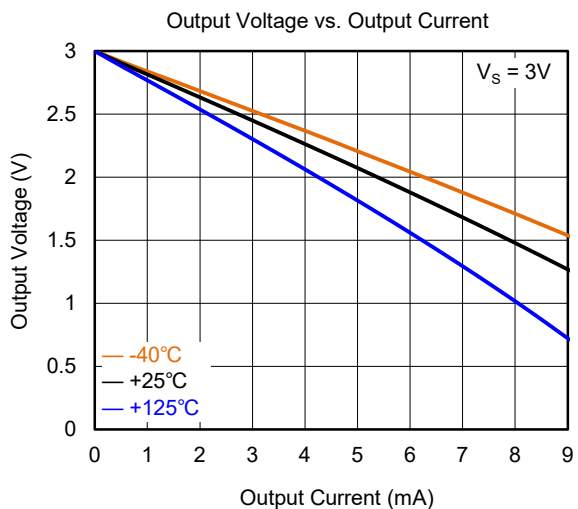
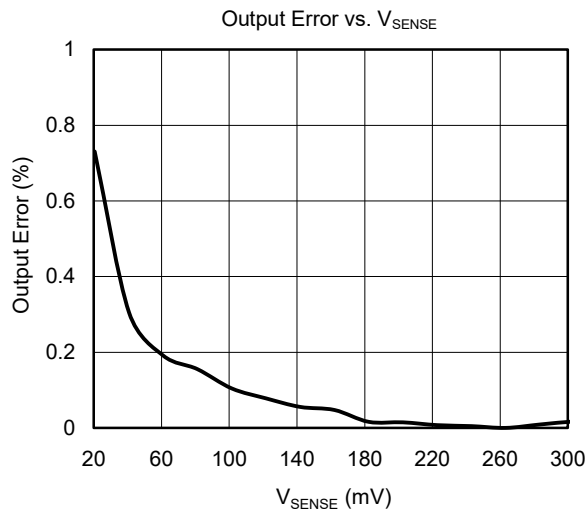
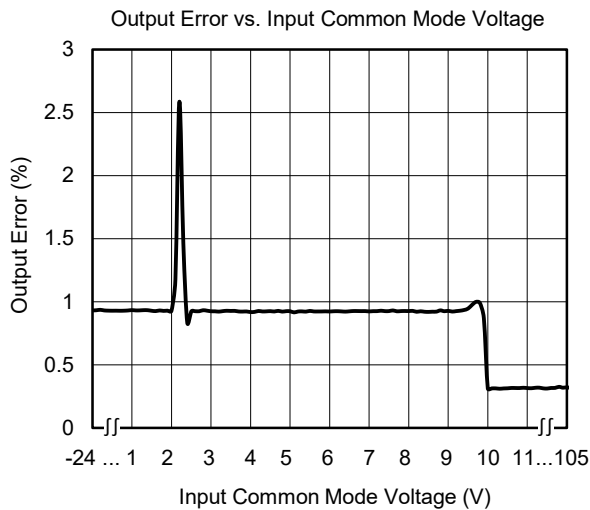
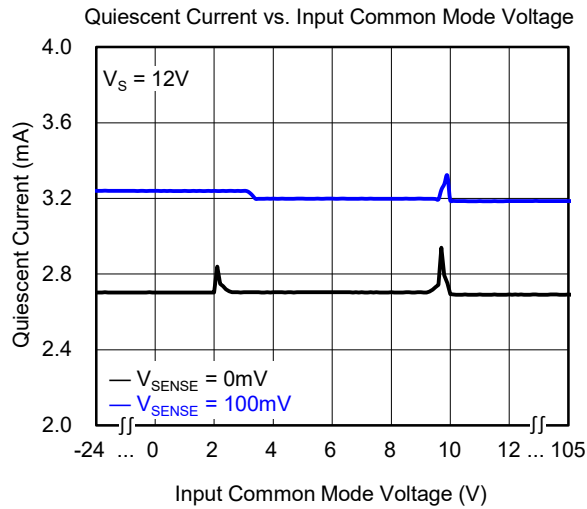
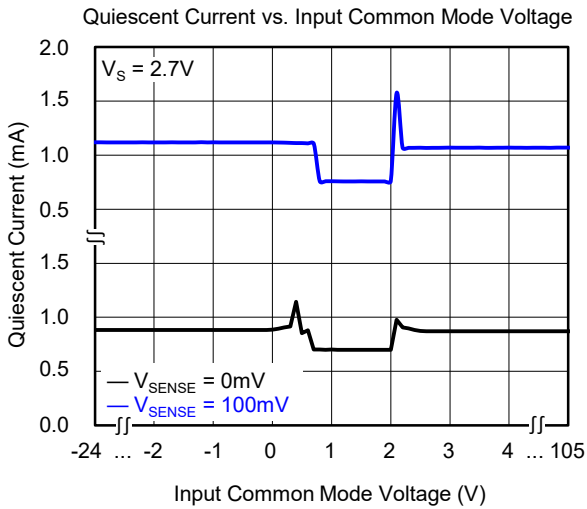

Automotive, High-Side Current-Sense Amplifier with Open-Drain Comparator and Reference

SGM8197xQ

TYPICAL PERFORMANCE CHARACTERISTICS (continued)

At $T_A = +25^\circ\text{C}$, $V_S = 12\text{V}$, $V_{IN+} = 12\text{V}$, and $V_{SENSE} = 100\text{mV}$, unless otherwise noted.

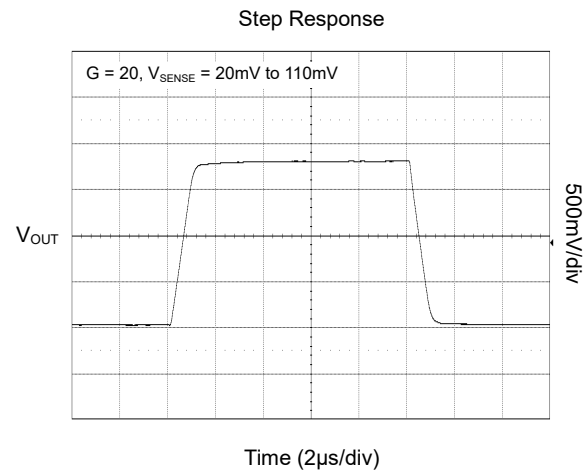
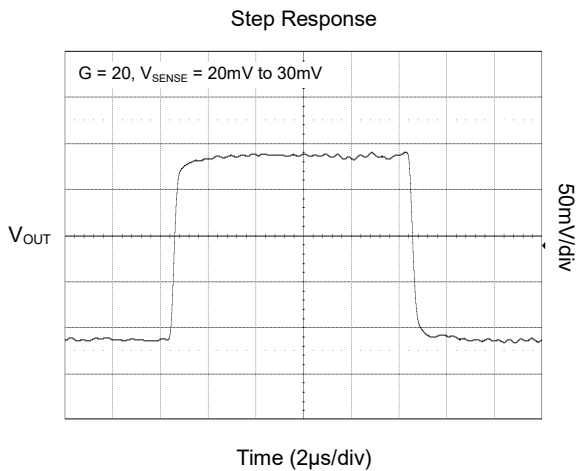
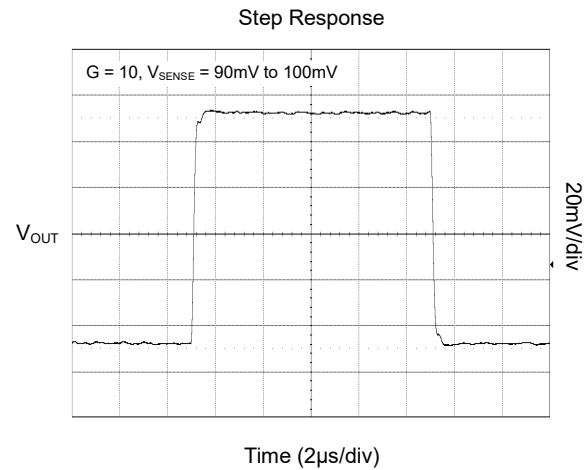
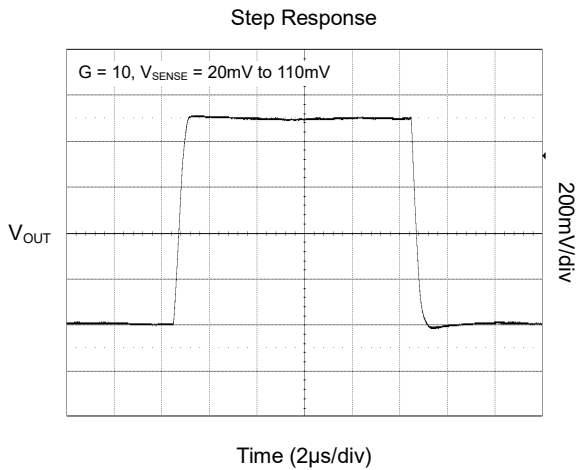
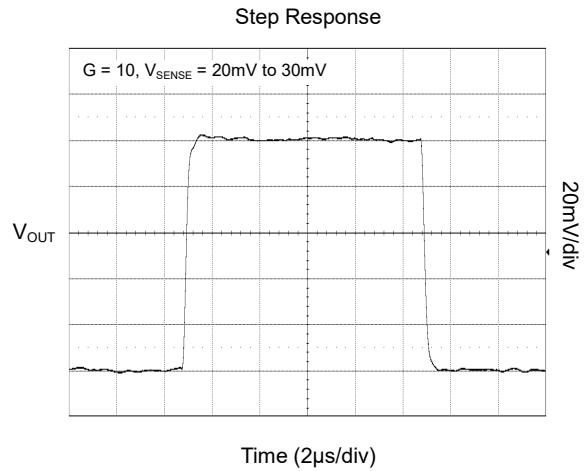
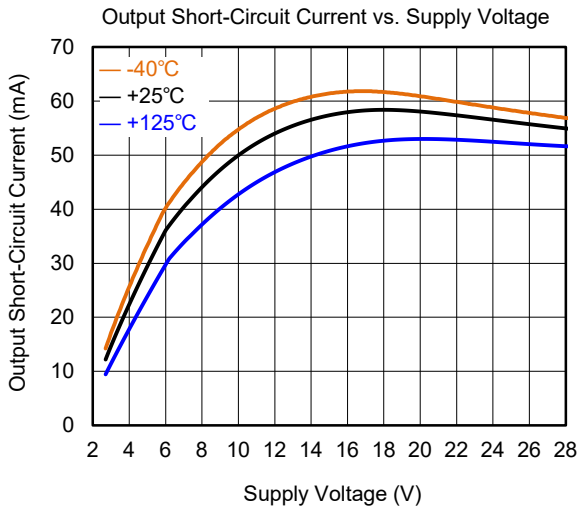

SGM8197xQ Automotive, High-Side Current-Sense Amplifier with Open-Drain Comparator and Reference

TYPICAL PERFORMANCE CHARACTERISTICS (continued)

At $T_A = +25^\circ\text{C}$, $V_S = 12\text{V}$, $V_{IN+} = 12\text{V}$, and $V_{SENSE} = 100\text{mV}$, unless otherwise noted.

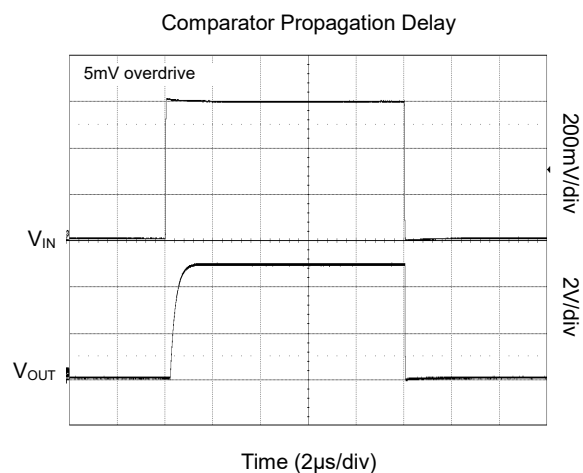
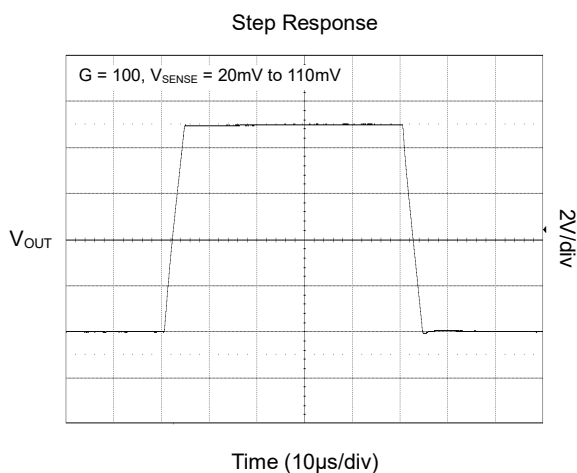
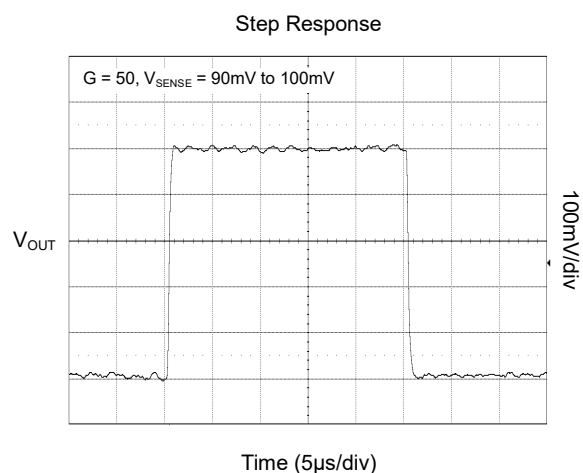
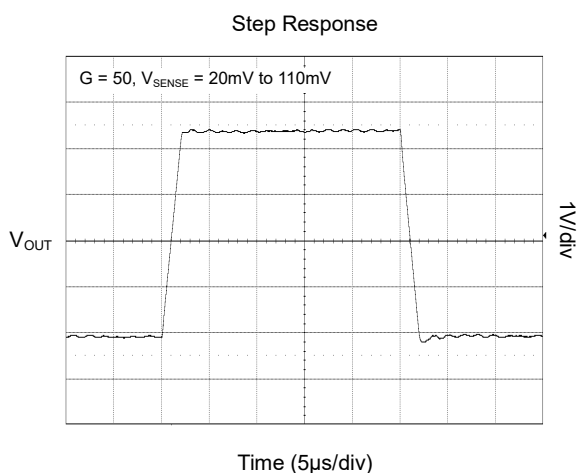
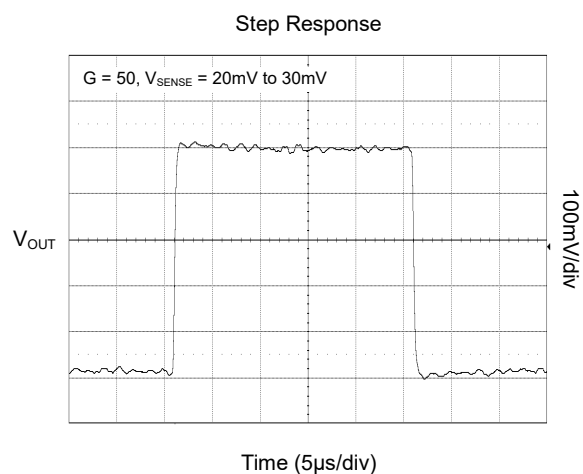
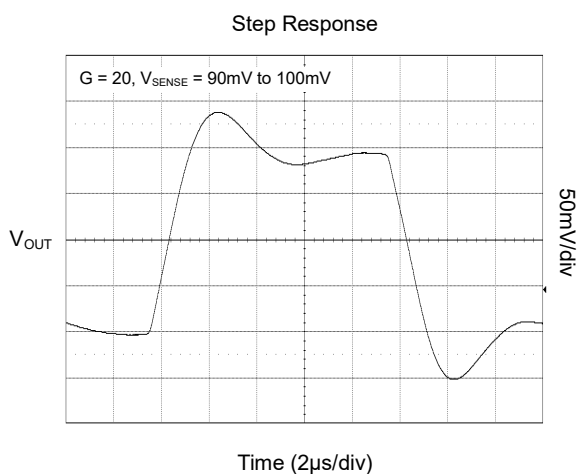

Automotive, High-Side Current-Sense Amplifier with Open-Drain Comparator and Reference

SGM8197xQ

TYPICAL PERFORMANCE CHARACTERISTICS (continued)

At $T_A = +25^\circ\text{C}$, $V_S = 12\text{V}$, $V_{IN+} = 12\text{V}$, and $V_{SENSE} = 100\text{mV}$, unless otherwise noted.

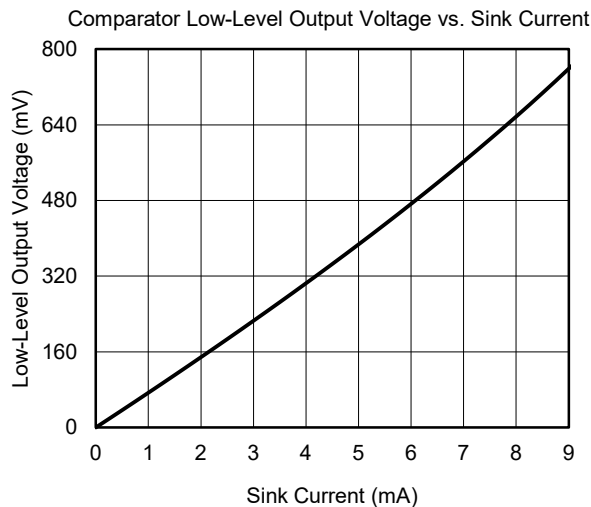
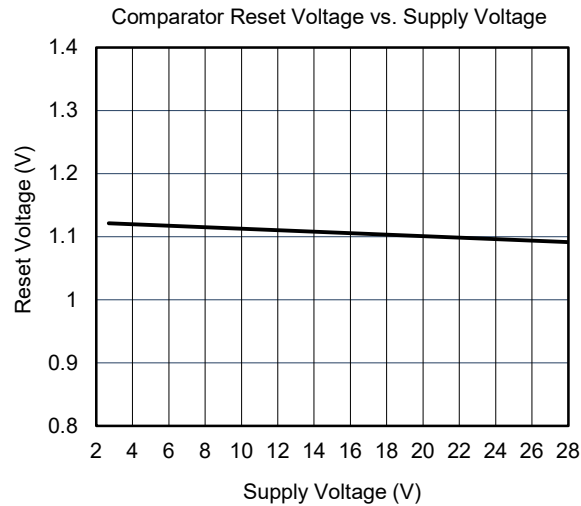
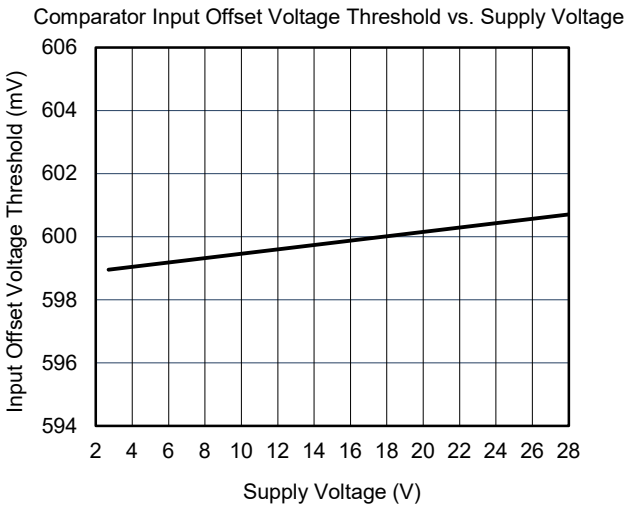
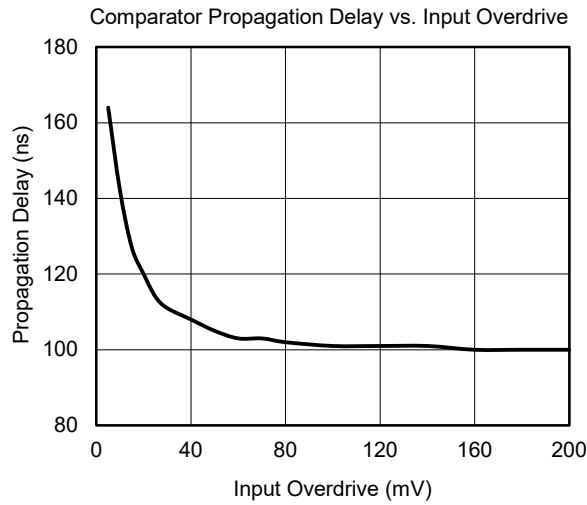
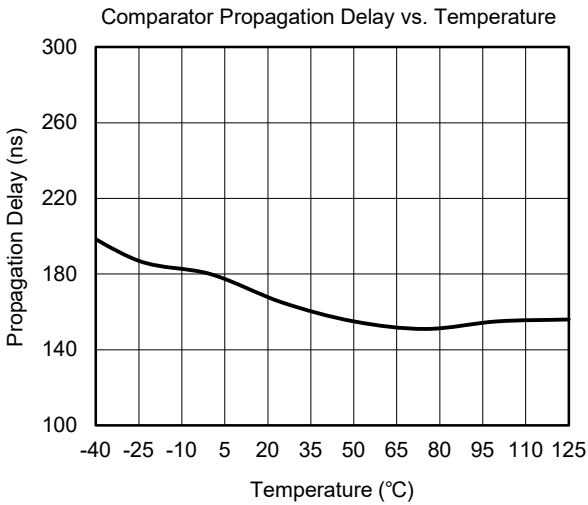

Automotive, High-Side Current-Sense Amplifier with Open-Drain Comparator and Reference

SGM8197xQ

DETAILED DESCRIPTION

The SGM8197xQ series is used for high-side current-sense applications with an integrated amplifier output and an open-drain comparator with a 0.6V reference. The device can work at common mode voltages from -24V to 105V. There are four different gains for SGM8197xQ series: 10V/V, 20V/V, 50V/V and 100V/V, and the bandwidth reaches 1200kHz for gain = 20V/V. An open-drain comparator with a 0.6V voltage reference (inverting input) is integrated. The current trip point can be set with the external voltage at CMP_{IN} pin. The comparator output can be transparent or latched, depending on whether the \overline{RESET} pin is pulled high or left floating (or grounded). The operating supply voltage of SGM8197xQ series is from 2.7V to 28V, with a typical supply current of 550 μ A. All versions are specified within -40°C to +125°C.

The Selection of R_{SHUNT}

The application of SGM8197xQ series will determine the selection of the shunt resistor R_{SHUNT} . Also, the users should consider the trade-off between voltage loss and the accuracy of small input signals. The effect of offset can be minimized by using high values of R_{SHUNT} , while the voltage loss can be minimized by using low values of R_{SHUNT} . For most applications, a voltage drop of 50mV to 100mV over R_{SHUNT} is the appropriate range for the selection of R_{SHUNT} .

Comparator

The SGM8197xQ series integrates an open-drain comparator with a 0.3 μ s (TYP) response time. The \overline{RESET} pin can be used to latch and reset the comparator output. The output is latched at the high level only, see Figure 4.

Figure 5 shows the SGM8197xQ in use as a high voltage load switch which has a high precision current-sense function and the open-drain output of the comparator is used to drive external high voltage MOSFET.

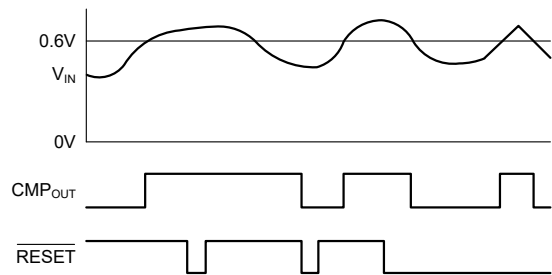

Figure 4. Capability of Latching

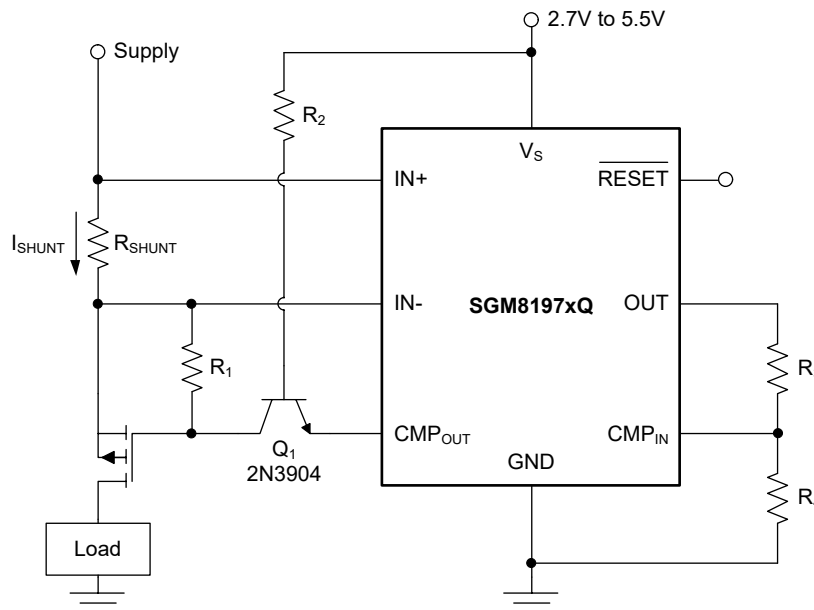

Figure 5. High Voltage Load Switch with High Precision Current-Sense Function

DETAILED DESCRIPTION (continued)

Input Filtering

It is not recommended to add a filter at the output of SGM8197xQ series, as doing so will increase impedance seen at the output of the internal buffer. Filtering at the input pins would be a good choice as long as the change of the input impedance is taken in account. The corresponding filtering circuit is shown in Figure 6. The shift in the initial gain and the effects on the gain tolerance can be minimized by choosing a low resistor value. Equation 1 shows the effect of the initial gain.

$$\text{Gain Error (\%)} = 100 - \left(100 \times \frac{5\text{k}\Omega}{5\text{k}\Omega + R_{\text{FILTER}}} \right) \quad (1)$$

Replacing the 5kΩ term with 5kΩ - 30% or 5kΩ + 30% is a way to calculate influence of the gain error. The

selection of R_{FILTER} should be substituted into the Equation 1. For example, the calculated error of gain is 1.96% if the customers replace the two 100Ω 1% resistors at the position of R_{FILTER} (shown in Figure 6). However, the worst case is that the internal input impedance is 5kΩ - 30% and the offset of R_{FILTER} is 3%. Under this worst situation, the error of gain would be larger than normal after calculation.

These tolerance should always be taken into consideration for the specified accuracy of the SGM8197xQ series. To calculate the variations of accuracy, it is recommended to use calculations of the root sum square or the geometric mean to evaluate the influence of the filtering resistor R_{FILTER} .

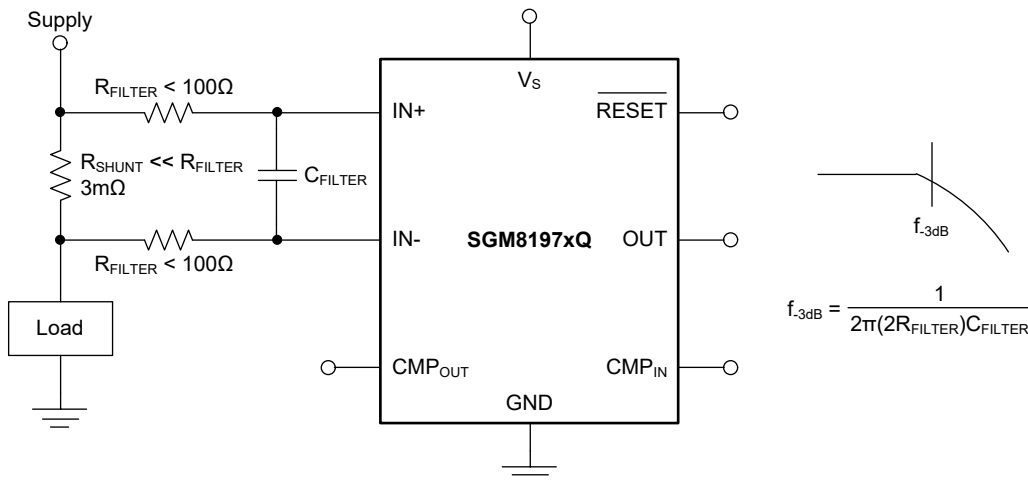

Figure 6. Filtering at the Input (Gain Error: 1.5% to 2.8%)

DETAILED DESCRIPTION (continued)

Variations of Accuracy Due to V_{SENSE} and V_{CM}

There are two conditions that influence the output accuracy of the SGM8197xQ series: V_{SENSE} (the voltage drop between the input pins of the current-sense monitor) and V_{CM} (defined as $(V_{IN+} + V_{IN-})/2$), and the above two variables are both related to the V_S (supply voltage). In the application, V_{CM} is nearly equal to V_{IN+} as the voltage between the two edges of the current-shunt resistor (V_{SENSE}) is small and can be neglected.

The following 6 cases show the extent of accuracy for SGM8197xQ series.

- Normal Case 1: $V_{CM} \geq V_S$, $V_{SENSE} \geq 20\text{mV}$.
- Normal Case 2: $V_{CM} < V_S$, $V_{SENSE} \geq 20\text{mV}$.
- Low V_{SENSE} Case 1: $-24\text{V} \leq V_{CM} < \text{GND}$, $V_{SENSE} < 20\text{mV}$.
- Low V_{SENSE} Case 2: $\text{GND} \leq V_{CM} \leq V_S$, $V_{SENSE} < 20\text{mV}$.
- Low V_{SENSE} Case 3: $V_S < V_{CM} \leq 105\text{V}$, $V_{SENSE} < 20\text{mV}$.

Normal Case 1: $V_{CM} \geq V_S$, $V_{SENSE} \geq 20\text{mV}$

The SGM8197xQ series has the greatest accuracy in this range. To explain, the input offset voltage can be measured with two steps.

First, the following equation can be used to calculate the gain of current-sense monitor:

$$G = \frac{V_{OUT1} - V_{OUT2}}{100\text{mV} - 20\text{mV}} \quad (2)$$

where:

- V_{OUT1} illustrates the output when $V_{SENSE} = 100\text{mV}$.
- V_{OUT2} illustrates the output when $V_{SENSE} = 20\text{mV}$.

After calculating the corresponding gain of the current-sense monitor, the following equation can also be used to calculate V_{OS} .

$$V_{OS\text{RTI}} \text{ (Referred to Input)} = \left(\frac{V_{OUT1}}{G} \right) - 100\text{mV} \quad (3)$$

Normal Case 2: $V_{CM} < V_S$, $V_{SENSE} \geq 20\text{mV}$

Operation in this common mode voltage range is slightly less accurate than Normal Case 1.

Low V_{SENSE} Case 1: $-24\text{V} \leq V_{CM} < \text{GND}$, $V_{SENSE} < 20\text{mV}$, and Low V_{SENSE} Case 3: $V_S < V_{CM} \leq 105\text{V}$, $V_{SENSE} < 20\text{mV}$

The SGM8197xQ series will operate accurately in these regions, if the sense voltage approaches 20mV. For lower sense voltages, the offset voltage will dominate the total output error and the accuracy will be reduced. Figure 7 shows this characteristics by using the SGM8197A3Q (100V/V).

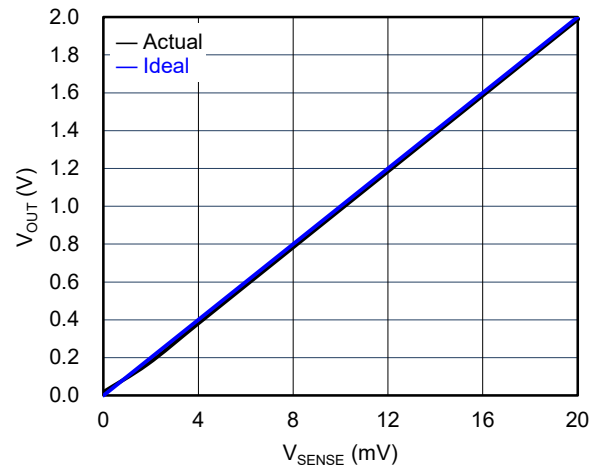

Figure 7. V_{OUT} vs. V_{SENSE} for Low V_{SENSE} Cases 1 and 3 (SGM8197A3Q, Gain = 100)

Low V_{SENSE} Case 2: $\text{GND} \leq V_{CM} \leq V_S$, $V_{SENSE} < 20\text{mV}$

For SGM8197xQ series, the operation accuracy of the current-sense monitor is the lowest. The current monitor uses two operational amplifiers in parallel for handling the the wide range of V_{CM} . One amplifier is used to handle the positive V_{CM} while the other is used to handle negative V_{CM} . However, in this case, both of the two amplifiers do not take a leading position which can result in low loop gain. In this region, if the voltage of V_{SENSE} approaches to 0V, the output of SGM8197xQ series may be fixed at a stable value, which means that it is unchangeable with the increasing or decreasing of the V_{SENSE} . However, if the voltage drop of V_{SENSE} approaches to 20mV, the output voltage is much closer to the actual value of V_{OUT} .

DETAILED DESCRIPTION (continued)

Transient Protection

The common mode voltage range of the SGM8197xQ series (-24V to 105V) is suitable for withstanding automotive fault conditions in the range between -24V and 105V, since there is no need for additional protective components to guarantee that the device can work at this level. If the operating condition of SGM8197xQ series is required to operate in the transients which are beyond this rating, an external transient absorber (such as a Zener) should be used. A semiconductor absorber of transient can be used to protect the device from this fault conditions. However, any MOVs or VDRs should not be taken into consideration for the protection. The transient absorber should be selected which guarantees that the exposure

voltage transient for SGM8197xQ is less than 105V. Although Zener-type ESD can be used to protect the device from any fault transient of voltage, the external resistors R_{FILTER} can not be used in series at the input pins of SGM8197xQ series as the internal gain resistors can reach $\pm 30\%$ of the typical values, which may cause the gain error of the current-sense monitor.

Range of Output Voltage

The maximum output voltage is limited by the supply voltage (V_S). For example, a 100mV full-scale input can be amplified to the output voltage of 10V by the current-sense amplifier SGM8197A3Q, so 10V power supply voltage is appropriate to achieve 10V output.

APPLICATION INFORMATION

Power Supply Decoupling

The SGM8197xQ series can accurately measure the current when the common mode voltage exceeds the power supply voltage presented at the V_S pin. For example, the V_S power supply can be 10V and the load or common mode power supply voltage is allowed to reach up to 105V. The output voltage range is limited by the level of the power supply.

The decoupling capacitor of the power supply pin must be close to the V_S and GND pins. 0.1 μ F to 0.47 μ F decoupling capacitor is recommended, but for noisy or high-impedance power supplies, additional decoupling capacitance need to be added.

Layout

Kelvin or 4-wire connection technique should be used to connect between the input pins of SGM8197xQ and the sensing resistor. And this kind of connection can guarantee that the resistance detected is the sensing resistor R_{SHUNT} only. For the placement of decoupling capacitor, the decoupling capacitor of the power supply pin must be closed to the V_S and GND pins.

REVISION HISTORY

NOTE: Page numbers for previous revisions may differ from page numbers in the current version.

Changes from Original (NOVEMBER 2023) to REV.A	Page
Changed from product preview to production data.....	All

PACKAGE OUTLINE DIMENSIONS

SOIC-8

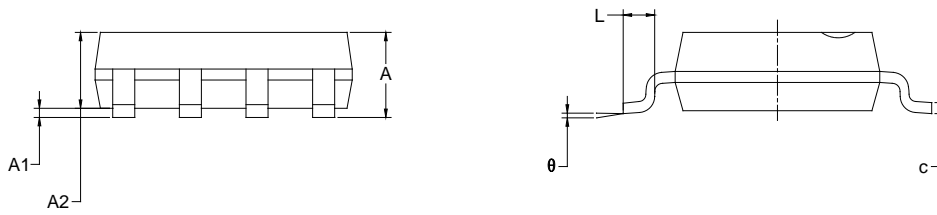
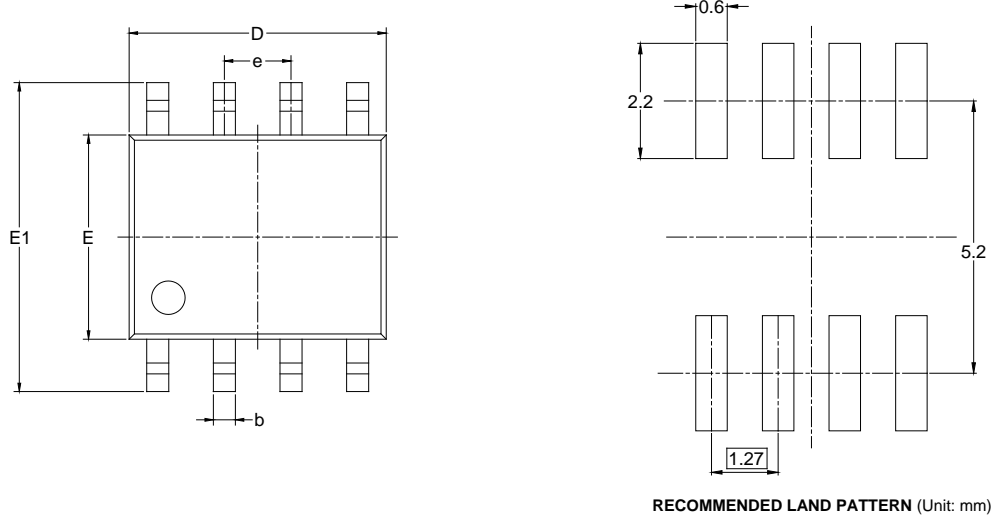

Symbol	Dimensions In Millimeters		Dimensions In Inches	
	MIN	MAX	MIN	MAX
A	1.350	1.750	0.053	0.069
A1	0.100	0.250	0.004	0.010
A2	1.350	1.550	0.053	0.061
b	0.330	0.510	0.013	0.020
c	0.170	0.250	0.006	0.010
D	4.700	5.100	0.185	0.200
E	3.800	4.000	0.150	0.157
E1	5.800	6.200	0.228	0.244
e	1.27 BSC		0.050 BSC	
L	0.400	1.270	0.016	0.050
θ	0°	8°	0°	8°

NOTES:
 1. Body dimensions do not include mode flash or protrusion.
 2. This drawing is subject to change without notice.

PACKAGE OUTLINE DIMENSIONS

MSOP-8

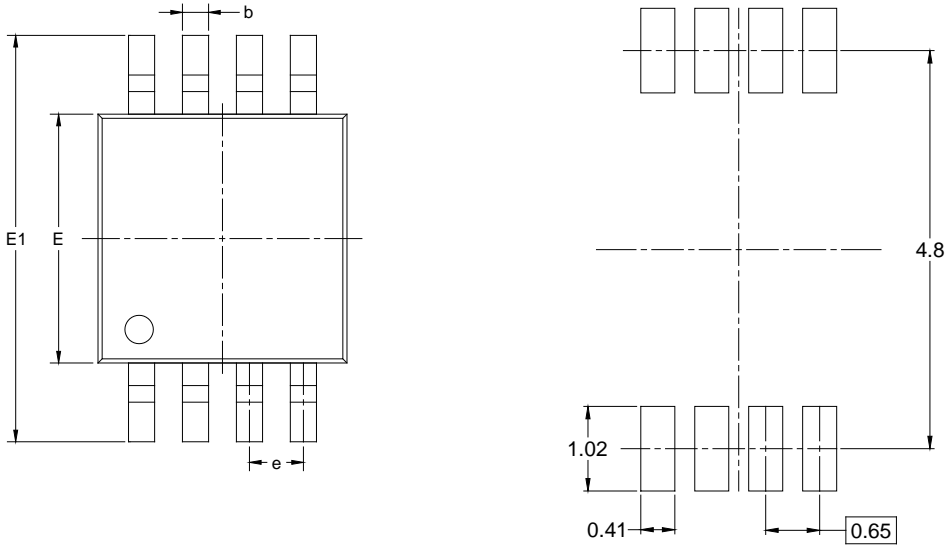

RECOMMENDED LAND PATTERN (Unit: mm)

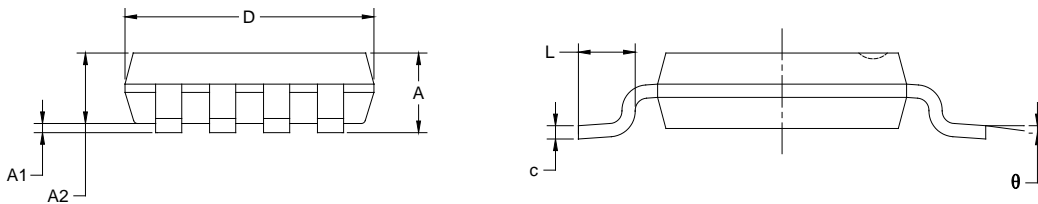

Symbol	Dimensions In Millimeters		Dimensions In Inches	
	MIN	MAX	MIN	MAX
A	0.820	1.100	0.032	0.043
A1	0.020	0.150	0.001	0.006
A2	0.750	0.950	0.030	0.037
b	0.250	0.380	0.010	0.015
c	0.090	0.230	0.004	0.009
D	2.900	3.100	0.114	0.122
E	2.900	3.100	0.114	0.122
E1	4.750	5.050	0.187	0.199
e	0.650 BSC		0.026 BSC	
L	0.400	0.800	0.016	0.031
θ	0°	6°	0°	6°

- NOTES:
 1. Body dimensions do not include mode flash or protrusion.
 2. This drawing is subject to change without notice.

PACKAGE INFORMATION

TAPE AND REEL INFORMATION

REEL DIMENSIONS

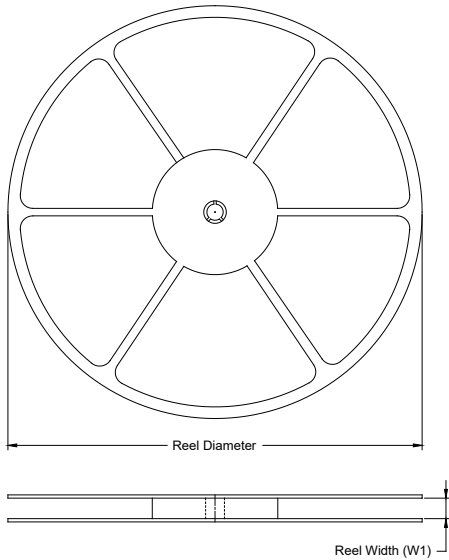

TAPE DIMENSIONS

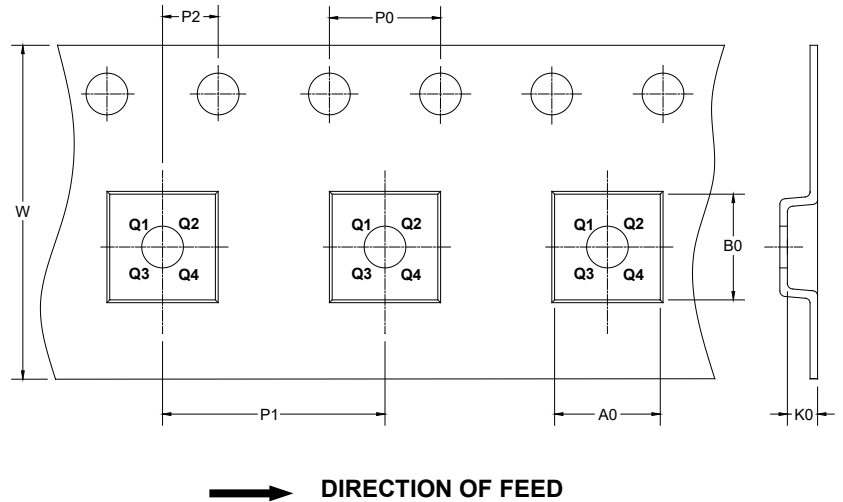

NOTE: The picture is only for reference. Please make the object as the standard.

KEY PARAMETER LIST OF TAPE AND REEL

Package Type	Reel Diameter	Reel Width W1 (mm)	A0 (mm)	B0 (mm)	K0 (mm)	P0 (mm)	P1 (mm)	P2 (mm)	W (mm)	Pin1 Quadrant
SOIC-8	13"	12.4	6.40	5.40	2.10	4.0	8.0	2.0	12.0	Q1
MSOP-8	13"	12.4	5.20	3.30	1.50	4.0	8.0	2.0	12.0	Q1

DD0001

PACKAGE INFORMATION

CARTON BOX DIMENSIONS



NOTE: The picture is only for reference. Please make the object as the standard.

KEY PARAMETER LIST OF CARTON BOX

Reel Type	Length (mm)	Width (mm)	Height (mm)	Pizza/Carton
13"	386	280	370	5

DD0002

单击下面可查看定价，库存，交付和生命周期等信息

[>>SGMICRO\(圣邦微电子\)](#)