

GENERAL DESCRIPTION

The SGM7SZ125 is a single buffer with three-state output with advanced CMOS technology. The supply voltage pin of this device accepts any voltage from 1.65V to 5.5V. The inputs can tolerate a maximum of 6V, regardless of the supply voltage range. When V_{CC} is at 0V, the inputs and output are in the high-impedance state. The output tolerates voltages above V_{CC} when in the 3-state condition.

This device can achieve ultra-high speed operation with high output drive, while the low static power dissipation over the wide supply voltage operating range is maintained.

The SGM7SZ125 is available in Green SOT-23-5 and SC70-5 packages. It operates over an ambient temperature range of -40°C to +85°C.

LOGIC SYMBOL

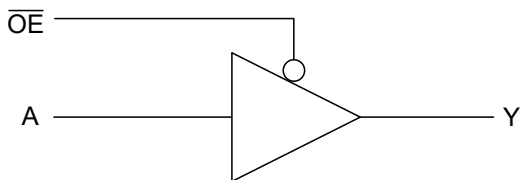

FEATURES

- **Wide Supply Voltage Range: 1.65V to 5.5V**
- **Ultra-High Speed: t_{PD} of 3.5ns (TYP) into 50pF at $V_{CC} = 3.3V$**
- **Support LCX Performance at $V_{CC} = 3.3V$**
- **High Output Drive: $\pm 24mA$ at $V_{CC} = 3V$**
- **Inputs Over-Voltage Tolerance Makes 5V to 3V Translation Available**
- **Power Down High-Impedance Inputs/Output**
- **Available in Green SOT-23-5 and SC70-5 Packages**

FUNCTION TABLE

INPUTS		OUTPUT
OE	A	Y
L	L	L
L	H	H
H	X	Z

H = HIGH Logic Level

L = LOW Logic Level

X = Don't Care

Z = HIGH Impedance State

PACKAGE/ORDERING INFORMATION

MODEL	PACKAGE DESCRIPTION	SPECIFIED TEMPERATURE RANGE	ORDERING NUMBER	PACKAGE MARKING	PACKING OPTION
SGM7SZ125	SC70-5	-40°C to +85°C	SGM7SZ125YC5G/TR	SFEXX	Tape and Reel, 3000
	SOT-23-5	-40°C to +85°C	SGM7SZ125YN5G/TR	SFFXX	Tape and Reel, 3000

MARKING INFORMATION

NOTE: XX = Date Code.

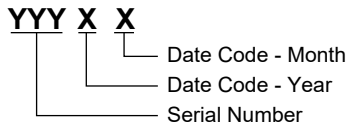

Green (RoHS & HSF): SG Micro Corp defines "Green" to mean Pb-Free (RoHS compatible) and free of halogen substances. If you have additional comments or questions, please contact your SGMICRO representative directly.

ABSOLUTE MAXIMUM RATINGS

- Supply Voltage, V_{CC} -0.5V to 6.0V
- DC Input Voltage, V_{IN} -0.5V to 6.0V
- DC Output Voltage, V_{OUT} -0.5V to 6.0V
- DC Input Diode Current, I_{IK}
($V_{IN} < -0.5V$).....-50mA
- DC Output Diode Current, I_{OK}
($V_{OUT} < -0.5V$)-50mA
- DC Output Current, I_{OUT} $\pm 50mA$
- DC V_{CC} or Ground Current, I_{CC} or I_{GND} $\pm 50mA$
- Junction Temperature+150°C
- Storage Temperature Range -65°C to +150°C
- Lead Temperature (Soldering, 10s).....+260°C
- ESD Susceptibility
- HBM..... 8000V
- MM..... 400V

RECOMMENDED OPERATING CONDITIONS

- Operating Temperature Range -40°C to +85°C

OVERSTRESS CAUTION

Stresses beyond those listed in Absolute Maximum Ratings may cause permanent damage to the device. Exposure to absolute maximum rating conditions for extended periods may affect reliability. Functional operation of the device at any conditions beyond those indicated in the Recommended Operating Conditions section is not implied.

ESD SENSITIVITY CAUTION

This integrated circuit can be damaged if ESD protections are not considered carefully. SGMICRO recommends that all integrated circuits be handled with appropriate precautions. Failure to observe proper handling and installation procedures can cause damage. ESD damage can range from subtle performance degradation to complete device failure. Precision integrated circuits may be more susceptible to damage because even small parametric changes could cause the device not to meet the published specifications.

DISCLAIMER

SG Micro Corp reserves the right to make any change in circuit design, or specifications without prior notice.

PIN CONFIGURATIONS

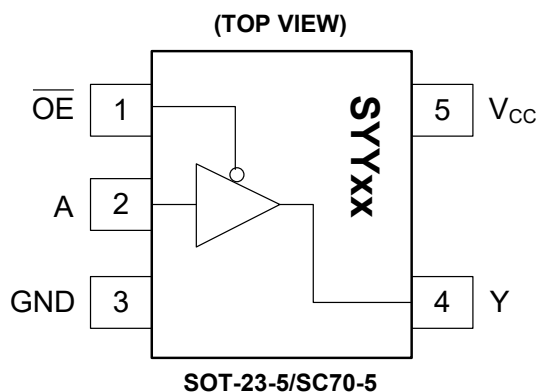

PIN DESCRIPTION

PIN	NAME	FUNCTION
1	\overline{OE}	Input. Unused input must be held high or low. It may not float.
2	A	Input. Unused input must be held high or low. It may not float.
3	GND	Ground.
4	Y	Output.
5	V _{CC}	Power Supply.

ELECTRICAL CHARACTERISTICS

(T_A = -40°C to +85°C, typical values are at T_A = +25°C, unless otherwise noted.)

PARAMETER	SYMBOL	CONDITIONS		V _{CC} (V)	MIN	TYP	MAX	UNITS
General								
Power Supply Range	V _{CC}				1.65		5.50	V
Supply Voltage Data Retention					1.50		5.50	V
Input Voltage	V _{IN}				0.00		5.50	V
Output Voltage	V _{OUT}	Active State			0.00		V _{CC}	V
		Three-State			0.00		5.50	
Input Rise and Fall Times	t _r , t _f			1.8, 2.5 ± 0.2	0		20	ns/V
				3.3 ± 0.3	0		10	
				5.0 ± 0.5	0		5	
DC Performance								
HIGH Level Input Voltage	V _{IH}			1.65 to 5.5	0.75V _{CC}			V
LOW Level Input Voltage	V _{IL}			1.65 to 5.5			0.25V _{CC}	V
HIGH Level Output Voltage	V _{OH}	V _{IN} = V _{IH}	I _{OH} = -100μA	1.65	1.62	1.65		V
				1.80	1.77	1.80		
				2.30	2.27	2.30		
				3.00	2.97	3.00		
			4.50	4.47	4.50			
			I _{OH} = -4mA	1.65	1.46	1.55		
			I _{OH} = -8mA	2.30	2.03	2.18		
			I _{OH} = -16mA	3.00	2.51	2.81		
			I _{OH} = -24mA	3.00	2.34	2.70		
I _{OH} = -32mA	4.50	4.01	4.20					
LOW Level Output Voltage	V _{OL}	V _{IN} = V _{IL}	I _{OL} = 100μA	1.65		0.00	0.02	V
				1.80		0.00	0.02	
				2.30		0.00	0.02	
				3.00		0.00	0.02	
			4.50		0.00	0.02		
			I _{OL} = 4mA	1.65		0.06	0.11	
			I _{OL} = 8mA	2.30		0.09	0.17	
			I _{OL} = 16mA	3.00		0.16	0.32	
			I _{OL} = 24mA	3.00		0.24	0.49	
I _{OL} = 32mA	4.50		0.29	0.55				
Input Leakage Current	I _{IN}	V _{IN} = 5.5V, GND		0 to 5.5		±0.10	±5	μA
3-STATE Output Leakage	I _{OZ}	V _{IN} = V _{IH} or V _{IL} , 0V ≤ V _{OUT} ≤ 5V		0 to 5.5		0.10	±5	μA
Power Off Leakage Current	I _{OFF}	V _{IN} or V _{OUT} = 5.5V		0		0.10	5	μA
Quiescent Supply Current	I _{CC}	V _{IN} = 5.5V, GND		1.65 to 5.5		0.10	10	μA

ELECTRICAL CHARACTERISTICS (continued)(T_A = -40°C to +85°C, typical values are at T_A = +25°C, unless otherwise noted.)

PARAMETER	SYMBOL	CONDITIONS		MIN	TYP	MAX	UNITS	
AC Performance								
Propagation Delay	t _{PHL} , t _{PLH}	V _{CC} = 1.65V	C _L = 15pF, R _D = 1MΩ, S ₁ = OPEN, Figure 1, Figure 2		8.7		ns	
		V _{CC} = 1.80V			7.0			
		V _{CC} = 2.50V ± 0.20V			4.0			
		V _{CC} = 3.30V ± 0.30V			3.0			
		V _{CC} = 5.00V ± 0.50V			2.3			
		V _{CC} = 3.30V ± 0.30V		C _L = 50pF, R _D = 500Ω, S ₁ = OPEN, Figure 1, Figure 2		3.5		
		V _{CC} = 5.00V ± 0.50V				2.6		
Output Enable Time	t _{PZL} , t _{PZH}	V _{CC} = 1.65V	C _L = 50pF, R _D = 500Ω, R _U = 500Ω, S ₁ = GND for t _{PZH} , S ₁ = V _{IN} for t _{PZL} , V _{IN} = 2V _{CC} , Figure 1, Figure 2		9.6		ns	
		V _{CC} = 1.80V			8.2			
		V _{CC} = 2.50V ± 0.20V			5.5			
		V _{CC} = 3.30V ± 0.30V			4.6			
		V _{CC} = 5.00V ± 0.50V			4.0			
Output Disable Time	t _{PLZ} , t _{PHZ}	V _{CC} = 1.65V	C _L = 50pF, R _D = 500Ω, R _U = 500Ω, S ₁ = GND for t _{PHZ} , S ₁ = V _{IN} for t _{PLZ} , V _{IN} = 2V _{CC} , Figure 1, Figure 2		9.7		ns	
		V _{CC} = 1.80V			8.1			
		V _{CC} = 2.50V ± 0.20V			3.9			
		V _{CC} = 3.30V ± 0.30V			3.0			
		V _{CC} = 5.00V ± 0.50V			2.4			
Input Capacitance	C _{IN}	V _{CC} = 0V			4.0		pF	
Output Capacitance	C _{OUT}	V _{CC} = 0V			6.0		pF	
Power Dissipation Capacitance ⁽²⁾	C _{PD}	V _{CC} = 3.30V	Figure 3		15.0		pF	
		V _{CC} = 5.00V			17.0			

NOTES:

- Unused inputs must be held HIGH or LOW. They may not float.
- C_{PD} is defined as the value of the internal equivalent capacitance which is derived from dynamic operating current consumption (I_{CCD}) at no output loading and operating at 50% duty cycle (see Figure 3). C_{PD} is related to dynamic operating current I_{CCD} by the expression: I_{CCD} = (C_{PD}) (V_{CC}) (f_{IN}) + (I_{CC,Static}).

TEST CIRCUITS

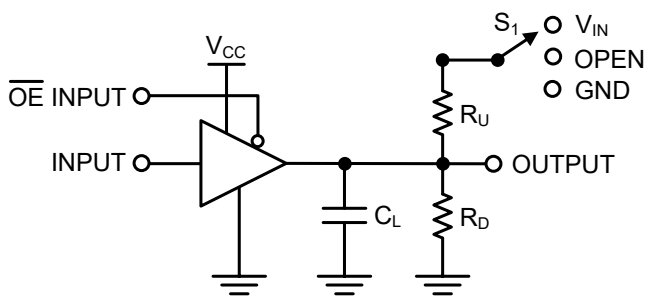

C_L includes load and stray capacitance;
Input PRR = 1.0MHz; t_w = 500ns.

Figure 1. AC Test Circuit

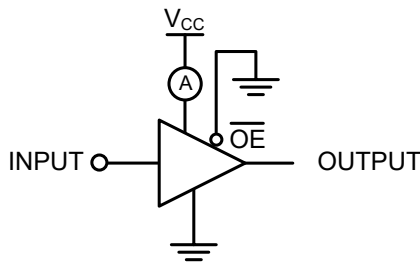

Input = AC Waveform; $t_r = t_f = 1.8$ ns;
PRR = 10MHz; Duty Cycle = 50%.

Figure 3. I_{CCD} Test Circuit

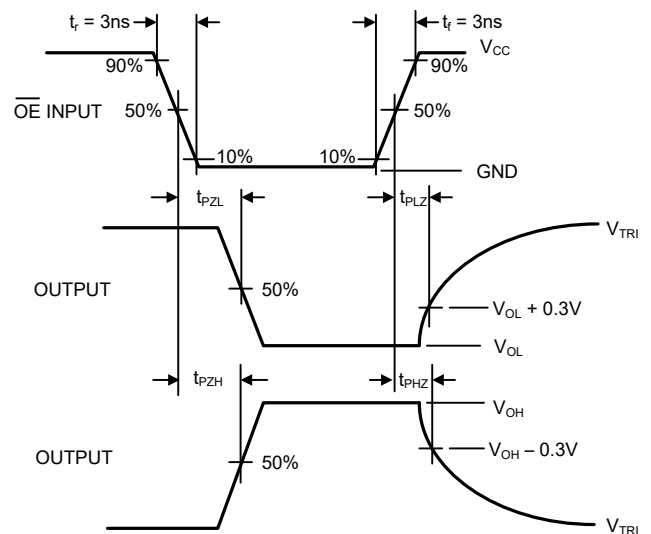
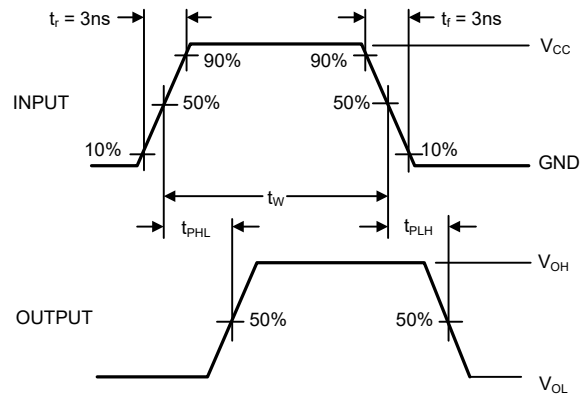

Figure 2. AC Waveforms

REVISION HISTORY

NOTE: Page numbers for previous revisions may differ from page numbers in the current version.

SEPTEMBER 2021 – REV.A to REV.A.1

	Page
Updated Package Outline Dimensions section	8

Changes from Original (OCTOBER 2013) to REV.A

	Page
Changed from product preview to production data	All

PACKAGE OUTLINE DIMENSIONS

SOT-23-5

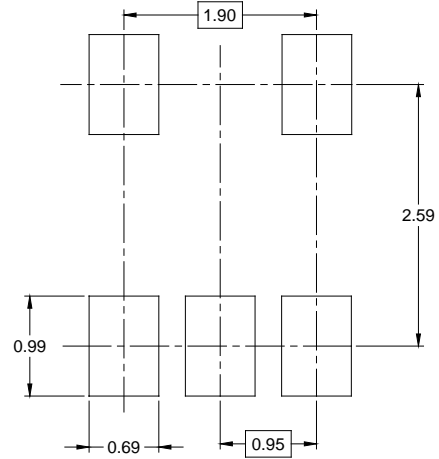
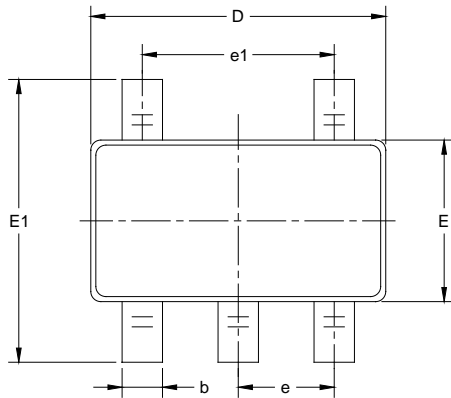

RECOMMENDED LAND PATTERN (Unit: mm)

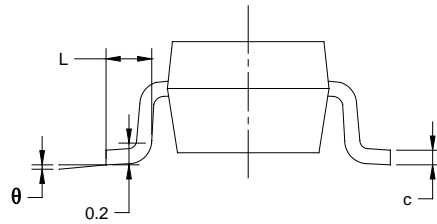
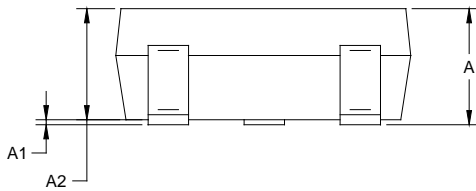

Symbol	Dimensions In Millimeters		Dimensions In Inches	
	MIN	MAX	MIN	MAX
A	1.050	1.250	0.041	0.049
A1	0.000	0.100	0.000	0.004
A2	1.050	1.150	0.041	0.045
b	0.300	0.500	0.012	0.020
c	0.100	0.200	0.004	0.008
D	2.820	3.020	0.111	0.119
E	1.500	1.700	0.059	0.067
E1	2.650	2.950	0.104	0.116
e	0.950 BSC		0.037 BSC	
e1	1.900 BSC		0.075 BSC	
L	0.300	0.600	0.012	0.024
θ	0°	8°	0°	8°

NOTES:

1. Body dimensions do not include mode flash or protrusion.
2. This drawing is subject to change without notice.

PACKAGE OUTLINE DIMENSIONS

SC70-5

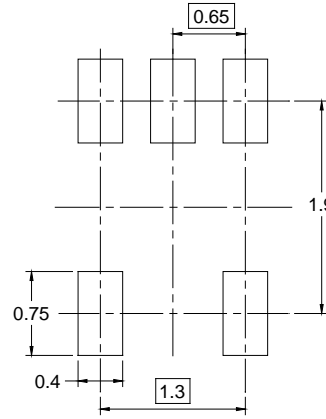
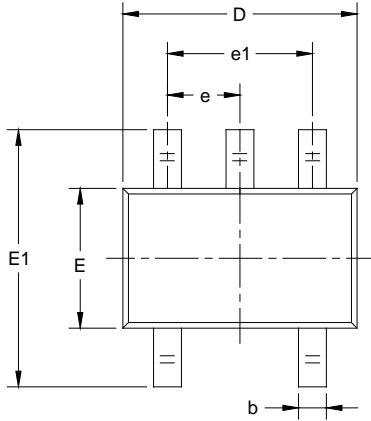

RECOMMENDED LAND PATTERN (Unit: mm)

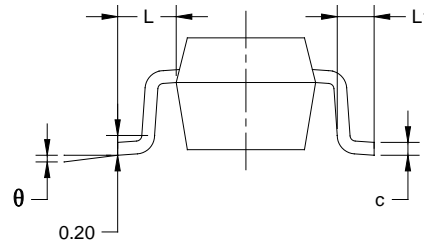
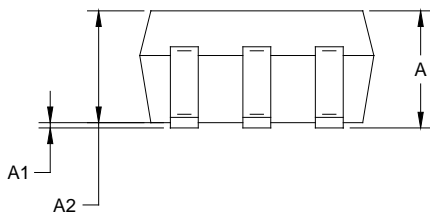

Symbol	Dimensions In Millimeters		Dimensions In Inches	
	MIN	MAX	MIN	MAX
A	0.800	1.100	0.031	0.043
A1	0.000	0.100	0.000	0.004
A2	0.800	1.000	0.031	0.039
b	0.150	0.350	0.006	0.014
c	0.080	0.220	0.003	0.009
D	2.000	2.200	0.079	0.087
E	1.150	1.350	0.045	0.053
E1	2.150	2.450	0.085	0.096
e	0.65 TYP		0.026 TYP	
e1	1.300 BSC		0.051 BSC	
L	0.525 REF		0.021 REF	
L1	0.260	0.460	0.010	0.018
θ	0°	8°	0°	8°

NOTES:

1. Body dimensions do not include mode flash or protrusion.
2. This drawing is subject to change without notice.

PACKAGE INFORMATION

TAPE AND REEL INFORMATION

REEL DIMENSIONS



TAPE DIMENSIONS



NOTE: The picture is only for reference. Please make the object as the standard.

KEY PARAMETER LIST OF TAPE AND REEL

Package Type	Reel Diameter	Reel Width W1 (mm)	A0 (mm)	B0 (mm)	K0 (mm)	P0 (mm)	P1 (mm)	P2 (mm)	W (mm)	Pin1 Quadrant
SOT-23-5	7"	9.5	3.20	3.20	1.40	4.0	4.0	2.0	8.0	Q3
SC70-5	7"	9.5	2.25	2.55	1.20	4.0	4.0	2.0	8.0	Q3

000001

PACKAGE INFORMATION

CARTON BOX DIMENSIONS



NOTE: The picture is only for reference. Please make the object as the standard.

KEY PARAMETER LIST OF CARTON BOX

Reel Type	Length (mm)	Width (mm)	Height (mm)	Pizza/Carton
7" (Option)	368	227	224	8
7"	442	410	224	18

DD0002

单击下面可查看定价，库存，交付和生命周期等信息

[>>SGMICRO\(圣邦微电子\)](#)