



SGM8551XN

Single-Supply, Single Rail-to-Rail I/O Precision Operational Amplifier

GENERAL DESCRIPTION

The SGM8551XN is a single, precision operational amplifier which can operate from 2.5V to 5.5V single supply. The device provides rail-to-rail input and output operation.

The SGM8551XN offers a low offset voltage of 12 μ V and an ultra-low bias current of 19pA. The combination of characteristics makes the SGM8551XN a good choice for temperature measurements, pressure and position sensors, strain gauge amplifiers and medical instrumentation, or any other 2.5V to 5.5V applications requiring precision and long-term stability.

The SGM8551XN is available in a Green SOT-23-5 package. It is specified over the extended industrial temperature range (-40°C to +125°C).

FEATURES

- **Low Offset Voltage: 12 μ V (TYP) at 5V**
- **Ultra-Low Input Bias Current: 19pA**
- **Large-Signal Voltage Gain: 145dB (TYP) at 5V**
- **PSRR: 110dB (TYP)**
- **CMRR: 105dB (TYP)**
- **Overload Recovery Time: 0.1ms (at $V_S = 5V$)**
- **Rail-to-Rail Input and Output**
- **Supply Voltage Range: 2.5V to 5.5V**
- **Low Supply Current: 465 μ A (TYP)**
- **No External Capacitors Required**
- **-40°C to +125°C Operating Temperature Range**
- **Available in a Green SOT-23-5 Package**

APPLICATIONS

Pressure Sensors
Temperature Measurements
Precision Current Sensing
Electronic Scales
Strain Gauge Amplifiers
Handheld Test Equipment
Thermocouple Amplifiers
Medical Instrumentation

PACKAGE/ORDERING INFORMATION

MODEL	PACKAGE DESCRIPTION	SPECIFIED TEMPERATURE RANGE	ORDERING NUMBER	PACKAGE MARKING	PACKING OPTION
SGM8551XN	SOT-23-5	-40°C to +125°C	SGM8551XN5G/TR	S06XX	Tape and Reel, 3000

MARKING INFORMATION

NOTE: XX = Date Code.

YYY X X

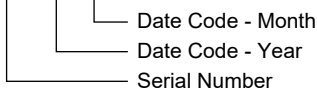

Green (RoHS & HSF): SG Micro Corp defines "Green" to mean Pb-Free (RoHS compatible) and free of halogen substances. If you have additional comments or questions, please contact your SGMICRO representative directly.

ABSOLUTE MAXIMUM RATINGS

Supply Voltage.....	6V
Input Voltage Range.....	-V _S to (+V _S) + 0.1V
Differential Input Voltage Range.....	-5V to 5V
Junction Temperature.....	+150°C
Storage Temperature Range.....	-65°C to +150°C
Lead Temperature (Soldering, 10s).....	+260°C
ESD Susceptibility	
HBM.....	4000V
MM.....	400V

RECOMMENDED OPERATING CONDITIONS

Operating Temperature Range.....	-40°C to +125°C
----------------------------------	-----------------

OVERSTRESS CAUTION

Stresses beyond those listed in Absolute Maximum Ratings may cause permanent damage to the device. Exposure to absolute maximum rating conditions for extended periods may affect reliability. Functional operation of the device at any conditions beyond those indicated in the Recommended Operating Conditions section is not implied.

ESD SENSITIVITY CAUTION

This integrated circuit can be damaged if ESD protections are not considered carefully. SGMICRO recommends that all integrated circuits be handled with appropriate precautions. Failure to observe proper handling and installation procedures

can cause damage. ESD damage can range from subtle performance degradation to complete device failure. Precision integrated circuits may be more susceptible to damage because even small parametric changes could cause the device not to meet the published specifications.

DISCLAIMER

SG Micro Corp reserves the right to make any change in circuit design, or specifications without prior notice.

PIN CONFIGURATION

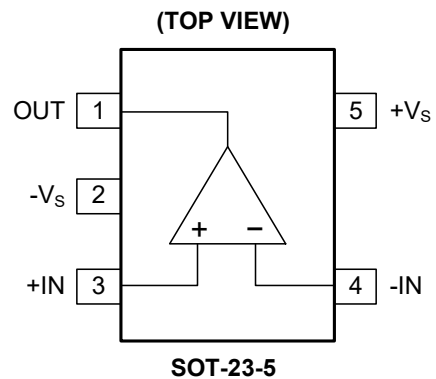

ELECTRICAL CHARACTERISTICS(At $T_A = +25^\circ\text{C}$, $V_S = 5\text{V}$, $V_{\text{CM}} = 2.5\text{V}$, $V_{\text{OUT}} = 2.5\text{V}$, unless otherwise noted.)

PARAMETER	CONDITIONS	MIN	TYP	MAX	UNITS
Input Characteristics					
Input Offset Voltage (V_{OS})			12	20	μV
	$-40^\circ\text{C} \leq T_A \leq +125^\circ\text{C}$			28	
Input Bias Current (I_b)			19		pA
Input Offset Current (I_{OS})			3		pA
Input Voltage Range		0		5	V
Common Mode Rejection Ratio ⁽¹⁾ (CMRR)	$V_{\text{CM}} = 0\text{V to } 5\text{V}$	90	105		dB
	$-40^\circ\text{C} \leq T_A \leq +125^\circ\text{C}$	86			
Large Signal Voltage Gain (A_{VO})	$R_L = 10\text{k}\Omega$, $V_{\text{OUT}} = 0.3\text{V to } 4.7\text{V}$	100	145		dB
	$-40^\circ\text{C} \leq T_A \leq +125^\circ\text{C}$	90			
Input Offset Voltage Drift ($\Delta V_{\text{OS}}/\Delta T$)	$-40^\circ\text{C} \leq T_A \leq +125^\circ\text{C}$		20		$\text{nV}/^\circ\text{C}$
Output Characteristics					
Output Voltage High (V_{OH})	$R_L = 100\text{k}\Omega$ to $-V_S$	4.99	4.998		V
	$-40^\circ\text{C} \leq T_A \leq +125^\circ\text{C}$	4.987			
	$R_L = 10\text{k}\Omega$ to $-V_S$	4.985	4.996		
	$-40^\circ\text{C} \leq T_A \leq +125^\circ\text{C}$	4.98			
Output Voltage Low (V_{OL})	$R_L = 100\text{k}\Omega$ to $+V_S$		2	10	mV
	$-40^\circ\text{C} \leq T_A \leq +125^\circ\text{C}$			13	
	$R_L = 10\text{k}\Omega$ to $+V_S$		6	15	
	$-40^\circ\text{C} \leq T_A \leq +125^\circ\text{C}$			20	
Short Circuit Limit (I_{SC})	$V_{\text{OUT}} = 2.5\text{V}$, $R_L = 10\Omega$ to GND	40	48		mA
	$-40^\circ\text{C} \leq T_A \leq +125^\circ\text{C}$	24			
Power Supply					
Power Supply Rejection Ratio ⁽¹⁾ (PSRR)	$V_S = 2.5\text{V to } 5.5\text{V}$	90	110		dB
	$-40^\circ\text{C} \leq T_A \leq +125^\circ\text{C}$	85			
Quiescent Current (I_Q)	$V_{\text{OUT}} = +V_S/2$		465	553	μA
	$-40^\circ\text{C} \leq T_A \leq +125^\circ\text{C}$			800	
Dynamic Performance					
Gain-Bandwidth Product (GBP)	$A_V = +100$		1.48		MHz
Slew Rate (SR)	$A_V = +1$, $R_L = 10\text{k}\Omega$, 2V output step		0.84		$\text{V}/\mu\text{s}$
Overload Recovery Time	$A_V = -100$, $R_L = 10\text{k}\Omega$, $V_{\text{IN}} = 200\text{mV}$ (RET to GND)		0.10		ms
Noise Performance					
Voltage Noise (e_n , p-p)	0.1Hz to 10Hz		0.90		$\mu\text{V}_{\text{P-P}}$
Voltage Noise Density (e_n)	$f = 1\text{kHz}$		53		$\text{nV}/\sqrt{\text{Hz}}$

NOTE: 1. PSRR and CMRR are affected by the matching between external gain-setting resistor ratios.

ELECTRICAL CHARACTERISTICS (continued)(At $T_A = +25^\circ\text{C}$, $V_S = 2.5\text{V}$, $V_{CM} = 1.25\text{V}$, $V_{OUT} = 1.25\text{V}$, unless otherwise noted.)

PARAMETER	CONDITIONS	MIN	TYP	MAX	UNITS
Input Characteristics					
Input Offset Voltage (V_{OS})			9	20	μV
	$-40^\circ\text{C} \leq T_A \leq +125^\circ\text{C}$			27	
Input Bias Current (I_b)			13		pA
Input Offset Current (I_{OS})			5		pA
Input Voltage Range		0		2.5	V
Common Mode Rejection Ratio ⁽¹⁾ (CMRR)	$V_{CM} = 0\text{V to } 2.5\text{V}$	90	105		dB
	$-40^\circ\text{C} \leq T_A \leq +125^\circ\text{C}$	86			
Large Signal Voltage Gain (A_{VO})	$R_L = 10\text{k}\Omega$, $V_{OUT} = 0.3\text{V to } 2.4\text{V}$	100	135		dB
	$-40^\circ\text{C} \leq T_A \leq +125^\circ\text{C}$	90			
Input Offset Voltage Drift ($\Delta V_{OS}/\Delta T$)	$-40^\circ\text{C} \leq T_A \leq +125^\circ\text{C}$		20		$\text{nV}/^\circ\text{C}$
Output Characteristics					
Output Voltage High (V_{OH})	$R_L = 100\text{k}\Omega$ to $-V_S$	2.49	2.499		V
	$-40^\circ\text{C} \leq T_A \leq +125^\circ\text{C}$	2.489			
	$R_L = 10\text{k}\Omega$ to $-V_S$	2.485	2.498		
	$-40^\circ\text{C} \leq T_A \leq +125^\circ\text{C}$	2.483			
Output Voltage Low (V_{OL})	$R_L = 100\text{k}\Omega$ to $+V_S$		1	10	mV
	$-40^\circ\text{C} \leq T_A \leq +125^\circ\text{C}$			11	
	$R_L = 10\text{k}\Omega$ to $+V_S$		3	15	
	$-40^\circ\text{C} \leq T_A \leq +125^\circ\text{C}$			17	
Short Circuit Limit (I_{SC})	$V_{OUT} = 1.25\text{V}$, $R_L = 10\Omega$ to GND	20	28		mA
	$-40^\circ\text{C} \leq T_A \leq +125^\circ\text{C}$	16			
Power Supply					
Power Supply Rejection Ratio ⁽¹⁾ (PSRR)	$V_S = 2.5\text{V to } 5.5\text{V}$	90	110		dB
	$-40^\circ\text{C} \leq T_A \leq +125^\circ\text{C}$	85			
Quiescent Current (I_Q)	$V_{OUT} = +V_S/2$		498	553	μA
	$-40^\circ\text{C} \leq T_A \leq +125^\circ\text{C}$			800	
Dynamic Performance					
Gain-Bandwidth Product (GBP)	$A_V = +100$		1.46		MHz
Slew Rate (SR)	$A_V = +1$, $R_L = 10\text{k}\Omega$, 2V output step		0.83		$\text{V}/\mu\text{s}$
Overload Recovery Time	$A_V = -100$, $R_L = 10\text{k}\Omega$, $V_{IN} = 200\text{mV}$ (RET to GND)		0.86		ms
Noise Performance					
Voltage Noise (e_n , p-p)	0.1Hz to 10Hz		0.90		μV_{P-P}
Voltage Noise Density (e_n)	$f = 1\text{kHz}$		55		$\text{nV}/\sqrt{\text{Hz}}$

NOTE: 1. PSRR and CMRR are affected by the matching between external gain-setting resistor ratios.

TYPICAL PERFORMANCE CHARACTERISTICS

Large Signal Transient Response at +5V

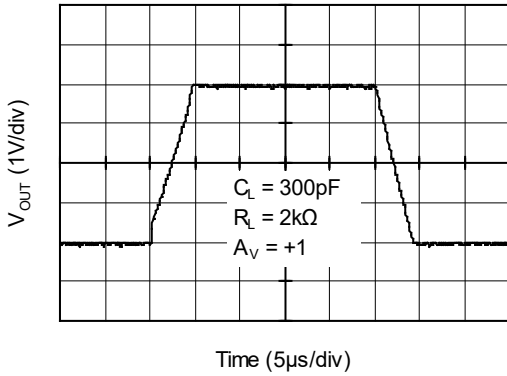

Large Signal Transient Response at +2.5V

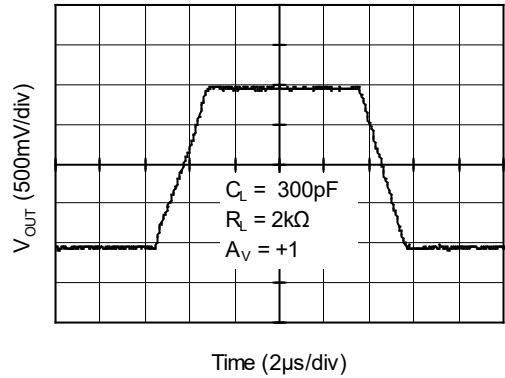

Small Signal Transient Response at +5V

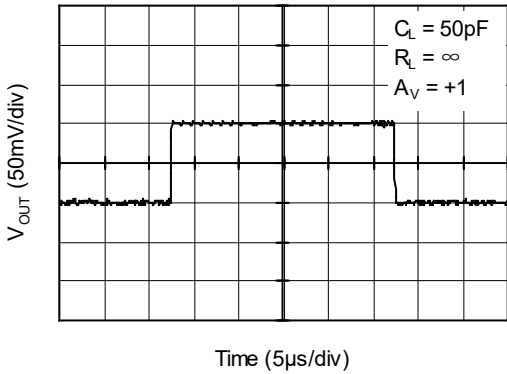

Small Signal Transient Response at +2.5V

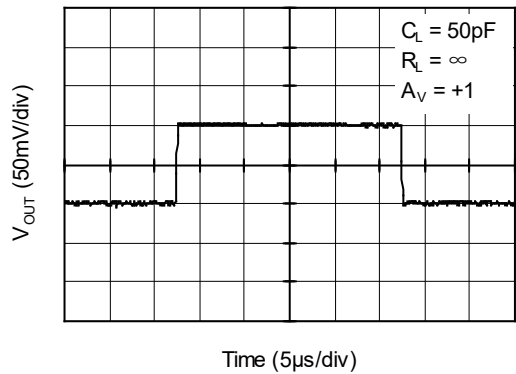

Closed Loop Gain vs. Frequency at +5V

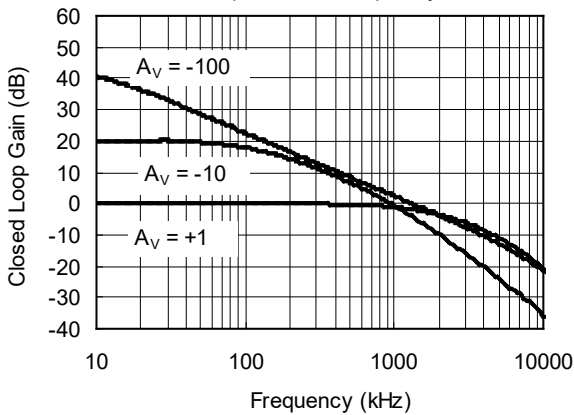

Closed Loop Gain vs. Frequency at +2.5V

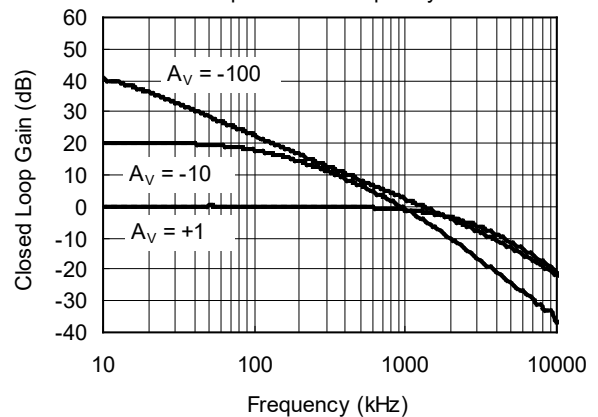

TYPICAL PERFORMANCE CHARACTERISTICS (continued)

Positive Overvoltage Recovery

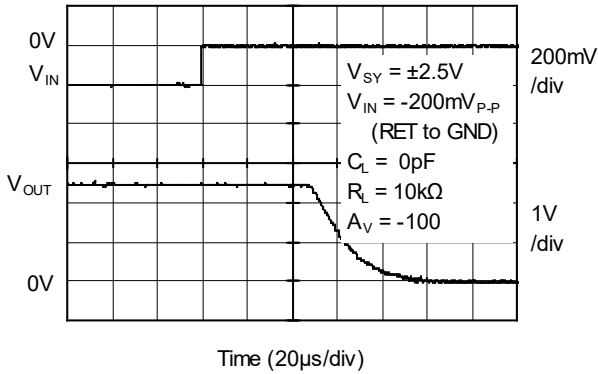

Negative Overvoltage Recovery

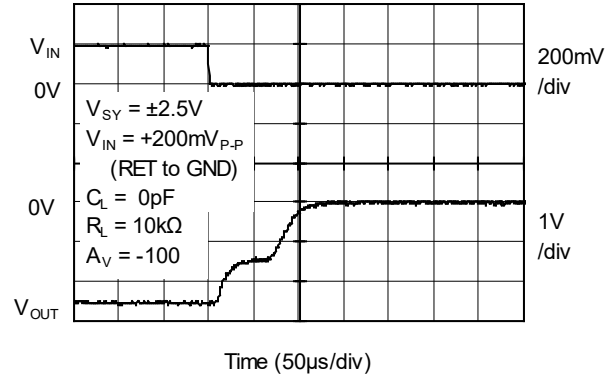

Open Loop Gain, Phase Shift vs. Frequency at +5V

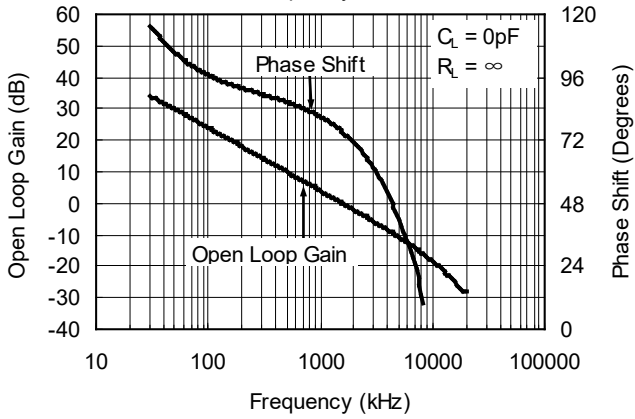

Open Loop Gain, Phase Shift vs. Frequency at +2.5V

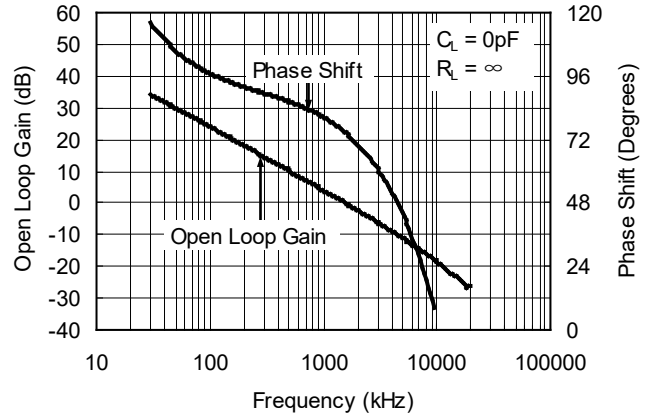

0.1Hz to 10Hz Noise at +5V

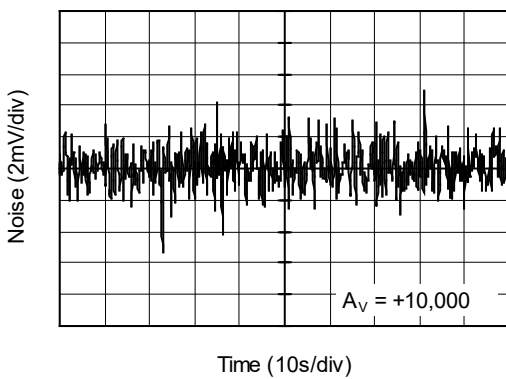

0.1Hz to 10Hz Noise at +2.5V

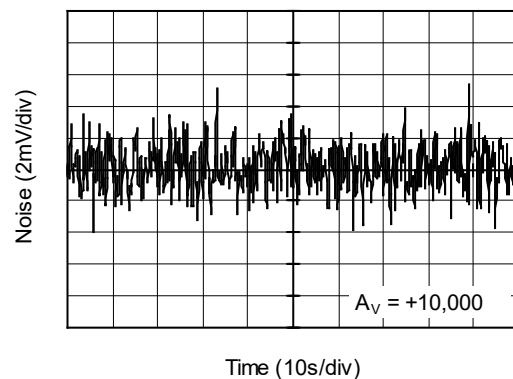

TYPICAL PERFORMANCE CHARACTERISTICS (continued)

Voltage Noise Density at +5V
from 0.1Hz to 2.5kHz

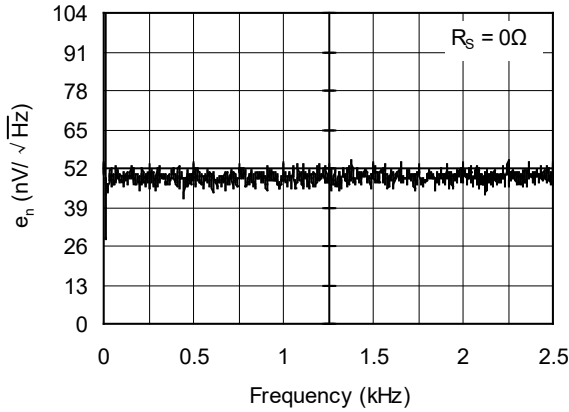

Voltage Noise Density at +2.5V
from 0.1Hz to 2.5kHz

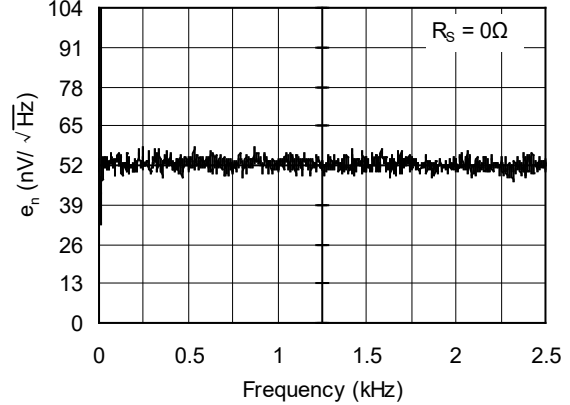

Voltage Noise Density at +5V
from 0.1Hz to 25kHz

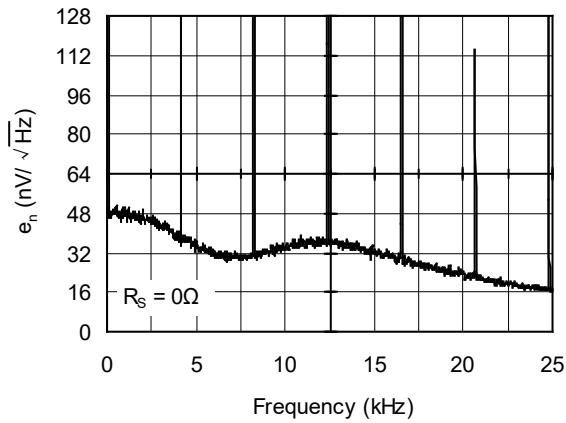

Voltage Noise Density at +2.5V
from 0.1Hz to 25kHz

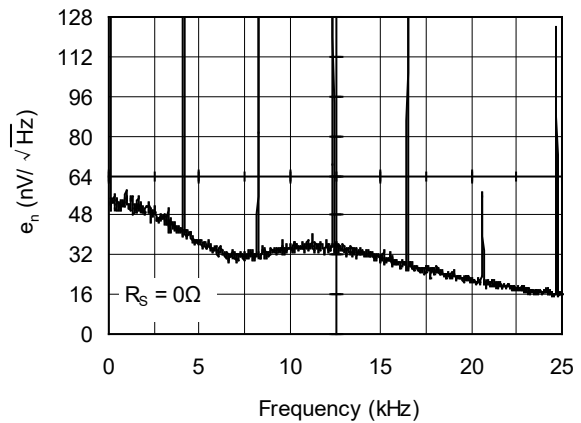

Offset Voltage Production Distribution at +5V

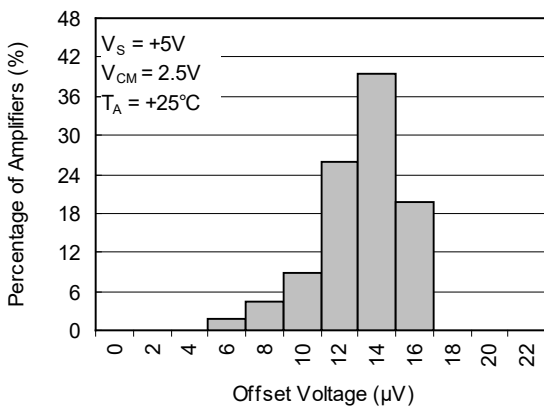

Offset Voltage Production Distribution at +2.5V

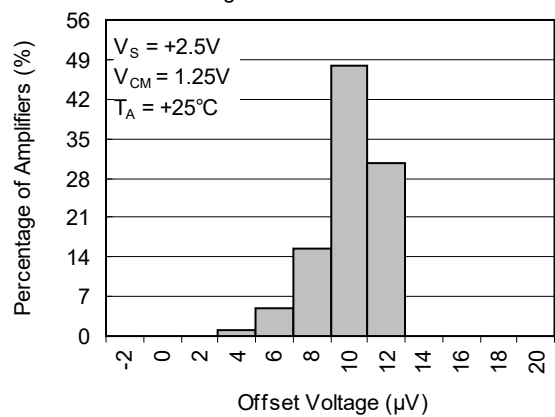

TYPICAL PERFORMANCE CHARACTERISTICS (continued)

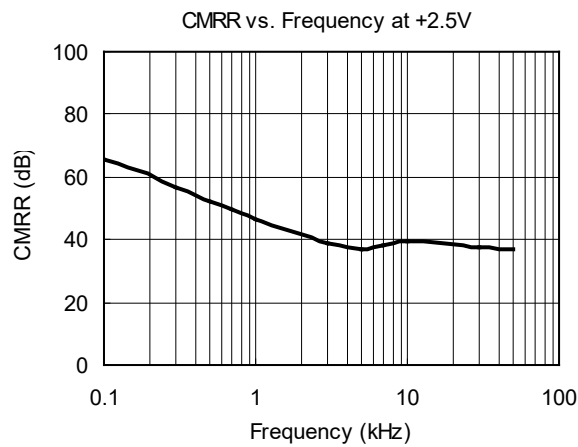
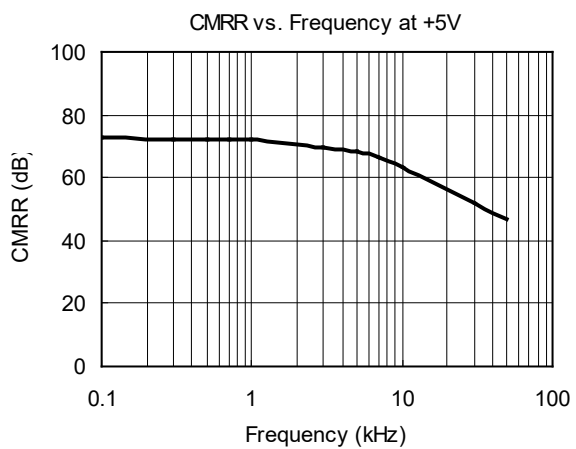

REVISION HISTORY

NOTE: Page numbers for previous revisions may differ from page numbers in the current version.

JANUARY 2013 – REV.A.3 to REV.A.4

Page

Added Tape and Reel Information section 11, 12

PACKAGE OUTLINE DIMENSIONS

SOT-23-5

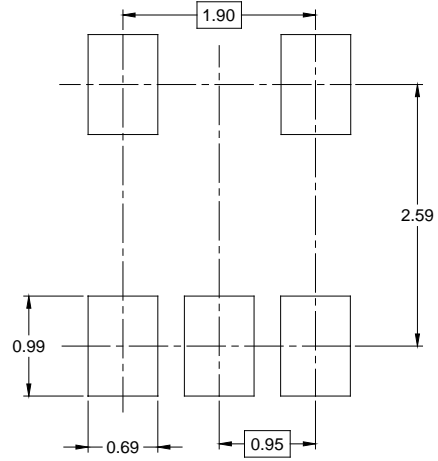
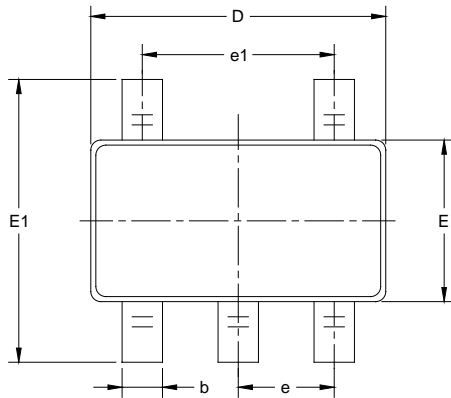

RECOMMENDED LAND PATTERN (Unit: mm)

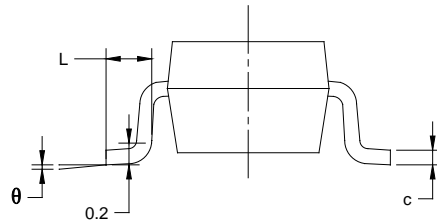
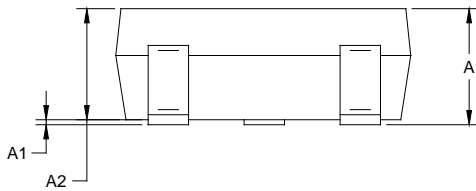

Symbol	Dimensions In Millimeters		Dimensions In Inches	
	MIN	MAX	MIN	MAX
A	1.050	1.250	0.041	0.049
A1	0.000	0.100	0.000	0.004
A2	1.050	1.150	0.041	0.045
b	0.300	0.500	0.012	0.020
c	0.100	0.200	0.004	0.008
D	2.820	3.020	0.111	0.119
E	1.500	1.700	0.059	0.067
E1	2.650	2.950	0.104	0.116
e	0.950 BSC		0.037 BSC	
e1	1.900 BSC		0.075 BSC	
L	0.300	0.600	0.012	0.024
θ	0°	8°	0°	8°

NOTES:

1. Body dimensions do not include mode flash or protrusion.
2. This drawing is subject to change without notice.

PACKAGE INFORMATION

TAPE AND REEL INFORMATION

REEL DIMENSIONS



TAPE DIMENSIONS



NOTE: The picture is only for reference. Please make the object as the standard.

KEY PARAMETER LIST OF TAPE AND REEL

Package Type	Reel Diameter	Reel Width W1 (mm)	A0 (mm)	B0 (mm)	K0 (mm)	P0 (mm)	P1 (mm)	P2 (mm)	W (mm)	Pin1 Quadrant
SOT-23-5	7"	9.5	3.20	3.20	1.40	4.0	4.0	2.0	8.0	Q3

000001

PACKAGE INFORMATION

CARTON BOX DIMENSIONS

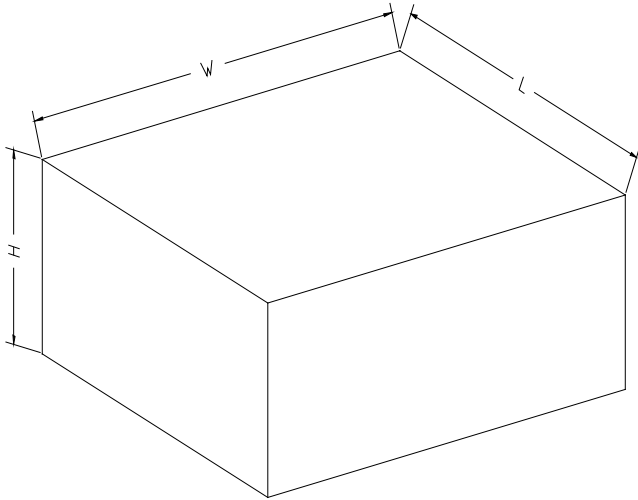

NOTE: The picture is only for reference. Please make the object as the standard.

KEY PARAMETER LIST OF CARTON BOX

Reel Type	Length (mm)	Width (mm)	Height (mm)	Pizza/Carton
7" (Option)	368	227	224	8
7"	442	410	224	18

DD0002

单击下面可查看定价，库存，交付和生命周期等信息

[>>SGMICRO\(圣邦微电子\)](#)