

### GENERAL DESCRIPTION

The SGM2575 is a single load switch with reverse current protection and controlled turn-on. The device can operate from 1V to 5.5V single supply and has the ability to drive up to 2A continuous current.

The device contains a 34mΩ low R<sub>ON</sub> N-MOSFET controlled by the ON pin. When the power supply is turned on for the first time, a smart pull-down resistor is used to float the ON pin until the system is stable. Once the ON pin reaches a high voltage (> V<sub>IH</sub>), the pull-down resistor is disconnected, then the standby current is very low and power loss can be reduced. The small package and low R<sub>ON</sub> make the device very suitable for space limited, battery powered applications.

The device supports a wide input voltage range, which is suitable for many different voltage rails. The rise time is used to avoid inrush current. The SGM2575AD/SGM2575BD offer the quick output discharge function in disable status.

The SGM2575 is available in a Green WLCSP-0.8×0.8-4B package.

### FEATURES

- **Input Voltage Range: 1V to 5.5V**
- **Maximum Continuous Current: 2A**
- **Low On-Resistance**
  - ◆ R<sub>ON</sub> = 34mΩ at V<sub>IN</sub> = 5V
  - ◆ R<sub>ON</sub> = 34mΩ at V<sub>IN</sub> = 3.3V
- **Low Shutdown Current: 90nA (TYP)**
- **Reverse Current Protection When Disabled**
- **Low Threshold 1.8V GPIO Control Input**
- **Bidirectional Power Supply for Power Zone Application**
- **Rise Time:**
  - ◆ SGM2575A/SGM2575AD: 60μs (TYP)
  - ◆ SGM2575BD: 1600μs (TYP)
- **Quick Output Discharge (SGM2575AD/SGM2575BD Only)**
- **Available in a Green WLCSP-0.8×0.8-4B Package**

### APPLICATIONS

- Mobile Phone
- Ultrabook
- Tablet PC
- Digital Camera
- Wearable Technology
- Solid State Drive

### TYPICAL APPLICATION

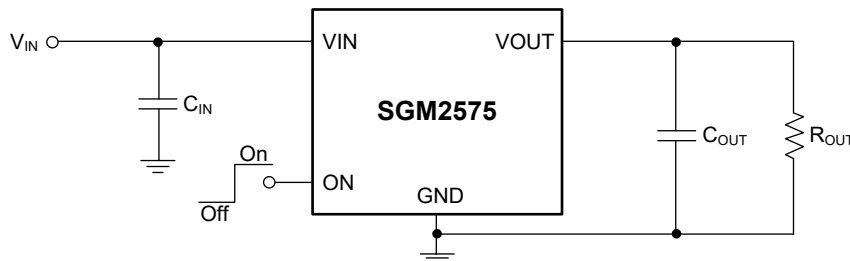

Figure 1. Typical Application Circuit

**PACKAGE/ORDERING INFORMATION**

MODEL	PACKAGE DESCRIPTION	SPECIFIED TEMPERATURE RANGE	ORDERING NUMBER	PACKAGE MARKING	PACKING OPTION
SGM2575A	WLCSP-0.8x0.8-4B	-40°C to +85°C	SGM2575AYG/TR	74 X	Tape and Reel, 3000
SGM2575AD	WLCSP-0.8x0.8-4B	-40°C to +85°C	SGM2575ADYG/TR	G0 X	Tape and Reel, 3000
SGM2575BD	WLCSP-0.8x0.8-4B	-40°C to +85°C	SGM2575BDYG/TR	D5 X	Tape and Reel, 3000

**MARKING INFORMATION**

NOTE: X = Date Code.

YY — Serial Number

X

└── Date Code - Quarter

Green (RoHS & HSF): SG Micro Corp defines "Green" to mean Pb-Free (RoHS compatible) and free of halogen substances. If you have additional comments or questions, please contact your SGMICRO representative directly.

**ABSOLUTE MAXIMUM RATINGS**

Input Voltage Range, V <sub>IN</sub> .....	-0.3V to 6V
Output Voltage Range, V <sub>OUT</sub> .....	-0.3V to 6V
ON Pin Voltage Range, V <sub>ON</sub> .....	-0.3V to 6V
Maximum Continuous Switch Current, I <sub>MAX</sub> .....	2A
Maximum Pulsed Switch Current, Pulse < 300µs, 2% Duty Cycle, I <sub>PLS</sub> .....	2.5A
Package Thermal Resistance	
WLCSP-0.8x0.8-4B, θ <sub>JA</sub> .....	236°C/W
WLCSP-0.8x0.8-4B, θ <sub>JB</sub> .....	45°C/W
WLCSP-0.8x0.8-4B, θ <sub>JC (top)</sub> .....	64°C/W
Junction Temperature.....	+150°C
Storage Temperature Range.....	-65°C to +150°C
Lead Temperature (Soldering, 10s).....	+260°C
ESD Susceptibility	
HBM.....	4000V
CDM.....	1000V

**RECOMMENDED OPERATING CONDITIONS**

Input Voltage Range, V <sub>IN</sub> .....	1V to 5.5V
Output Voltage Range, V <sub>OUT</sub> .....	0V to 5.5V
ON Pin Input High Voltage, V <sub>IH</sub> .....	1.1V to 5.5V
ON Pin Input Low Voltage, V <sub>IL</sub> .....	0V to 0.4V
Operating Ambient Temperature Range.....	-40°C to +85°C
Operating Junction Temperature Range.....	-40°C to +125°C

**OVERSTRESS CAUTION**

Stresses beyond those listed in Absolute Maximum Ratings may cause permanent damage to the device. Exposure to absolute maximum rating conditions for extended periods may affect reliability. Functional operation of the device at any conditions beyond those indicated in the Recommended Operating Conditions section is not implied.

**ESD SENSITIVITY CAUTION**

This integrated circuit can be damaged if ESD protections are not considered carefully. SGMICRO recommends that all integrated circuits be handled with appropriate precautions. Failure to observe proper handling and installation procedures can cause damage. ESD damage can range from subtle performance degradation to complete device failure. Precision integrated circuits may be more susceptible to damage because even small parametric changes could cause the device not to meet the published specifications.

**DISCLAIMER**

SG Micro Corp reserves the right to make any change in circuit design, or specifications without prior notice.

PIN CONFIGURATION

(TOP VIEW)

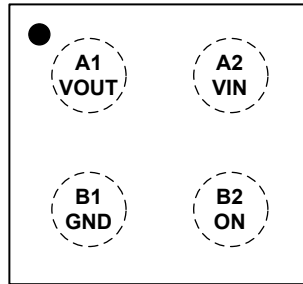

WLCSP-0.8×0.8-4B

PIN DESCRIPTION

PIN	NAME	DESCRIPTION
A1	VOUT	Switch Output.
A2	VIN	Switch Input. It is recommended to use a bypass capacitor (ceramic) to ground.
B1	GND	Ground.
B2	ON	Switch Control Input. Active high enables the device. Do not float this pin.

FUNCTIONAL BLOCK DIAGRAM

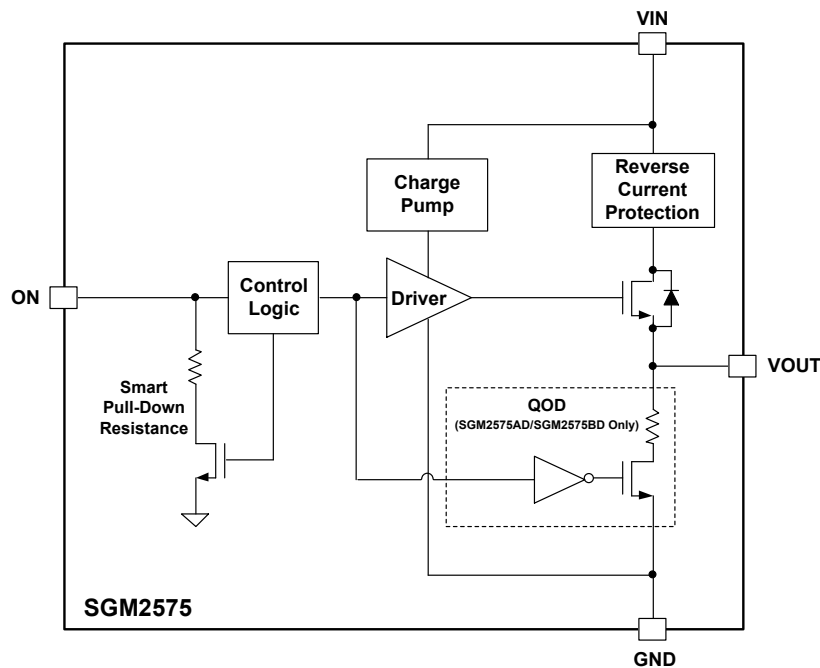

**ELECTRICAL CHARACTERISTICS**(T<sub>J</sub> = -40°C to +85°C, V<sub>IN</sub> = 1V to 5.5V, C<sub>IN</sub> = 1μF, C<sub>OUT</sub> = 0.1μF, typical values are at T<sub>J</sub> = +25°C, unless otherwise noted.)

PARAMETER	SYMBOL	CONDITIONS	MIN	TYP	MAX	UNITS
Input Voltage Range	V <sub>IN</sub>		1		5.5	V
Quiescent Current	I <sub>Q</sub>	V <sub>IN</sub> = 5V, V <sub>ON</sub> = 1.2V, I <sub>OUT</sub> = 0mA		320	560	nA
		V <sub>IN</sub> = 3.3V, V <sub>ON</sub> = 1.2V, I <sub>OUT</sub> = 0mA		220	400	
		V <sub>IN</sub> = 1V, V <sub>ON</sub> = 1.2V, I <sub>OUT</sub> = 0mA		140	300	
Shutdown Current	I <sub>SD</sub>	V <sub>IN</sub> = 5.5V, V <sub>ON</sub> = 0V		90	440	nA
Supply Leakage Current in Shutdown Mode	I <sub>LEAKAGE</sub>	V <sub>IN</sub> = 5.5V, V <sub>ON</sub> = 0V, V <sub>OUT</sub> = 0V			450	nA
On-Resistance	R <sub>ON</sub>	V <sub>IN</sub> = 5V, V <sub>ON</sub> = 1.2V, I <sub>OUT</sub> = -200mA		34	60	mΩ
		V <sub>IN</sub> = 3.3V, V <sub>ON</sub> = 1.2V, I <sub>OUT</sub> = -200mA		34	60	
ON Pin Leakage Current	I <sub>ON</sub>	V <sub>ON</sub> = 5.5V			420	nA
Reverse Current When Disabled	I <sub>RC</sub>	V <sub>IN</sub> = V <sub>ON</sub> = 0V, V <sub>OUT</sub> = 5V			1	μA
Output Pull-Down Resistance (SGM2575AD/SGM2575BD Only)	R <sub>PD</sub>	V <sub>IN</sub> = 2.5V, V <sub>ON</sub> = 0V, I <sub>OUT</sub> = 2mA		280	370	Ω
		V <sub>IN</sub> = 5V, V <sub>ON</sub> = 0V, I <sub>OUT</sub> = 2mA		270	360	
Smart Pull-Down Resistance	R <sub>PD_ON</sub>	Disabled		1.2		MΩ
ON Pin Input Low Voltage	V <sub>IL</sub>				0.4	V
ON Pin Input High Voltage	V <sub>IH</sub>		1.1			

**SWITCHING CHARACTERISTICS**

(T<sub>J</sub> = -40°C to +85°C, C<sub>IN</sub> = 1μF, R<sub>OUT</sub> = 10Ω, C<sub>OUT</sub> = 0.1μF, typical values are at T<sub>J</sub> = +25°C, unless otherwise noted.)

PARAMETER	SYMBOL	CONDITIONS	MIN	TYP	MAX	UNITS
<b>SGM2575A/SGM2575AD: V<sub>IN</sub> = 3.3V, unless otherwise noted.</b>						
Turn-On Time	t <sub>ON</sub>	Figure 2 and Figure 3		220		μs
Turn-Off Time	t <sub>OFF</sub>			20		
V <sub>OUT</sub> Rise Time	t <sub>R</sub>			85	130	
V <sub>OUT</sub> Fall Time	t <sub>F</sub>			2		
Delay Time	t <sub>D</sub>			205		
<b>SGM2575A/SGM2575AD: V<sub>IN</sub> = 5V, unless otherwise noted.</b>						
Turn-On Time	t <sub>ON</sub>	Figure 2 and Figure 3		185		μs
Turn-Off Time	t <sub>OFF</sub>			35		
V <sub>OUT</sub> Rise Time	t <sub>R</sub>			60	200	
V <sub>OUT</sub> Fall Time	t <sub>F</sub>			2		
Delay Time	t <sub>D</sub>			175		
<b>SGM2575BD: V<sub>IN</sub> = 3.3V, unless otherwise noted.</b>						
Turn-On Time	t <sub>ON</sub>	Figure 2 and Figure 3		900		μs
Turn-Off Time	t <sub>OFF</sub>			18		
V <sub>OUT</sub> Rise Time	t <sub>R</sub>			1600		
V <sub>OUT</sub> Fall Time	t <sub>F</sub>			3		
Delay Time	t <sub>D</sub>			400		

**PARAMETER MEASUREMENT INFORMATION**

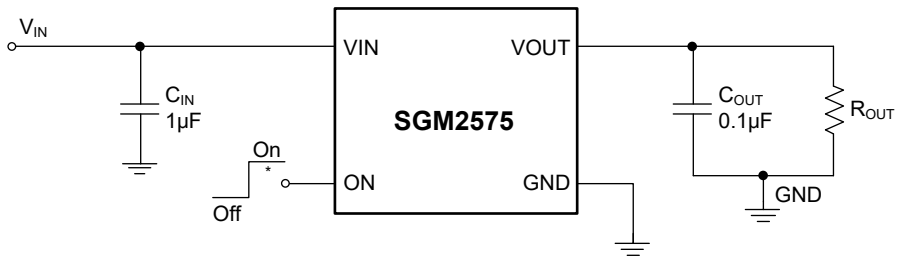

\*: Rise and fall times of the control signal are 100ns.

**Figure 2. Test Circuit**

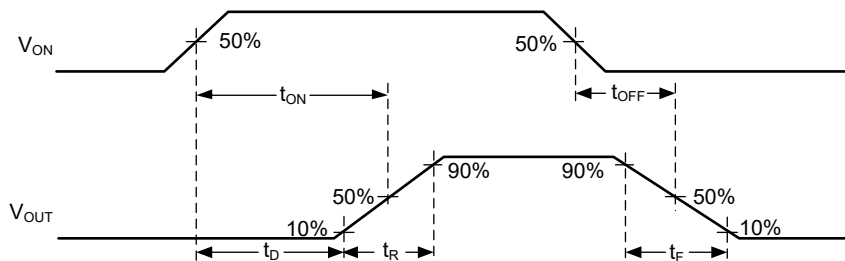

**Figure 3. Timing Waveforms**

TYPICAL PERFORMANCE CHARACTERISTICS

T<sub>J</sub> = +25°C, C<sub>IN</sub> = 1μF, C<sub>OUT</sub> = 0.1μF, R<sub>OUT</sub> = 10Ω, V<sub>IH</sub> = 1.2V, V<sub>IL</sub> = 0V, unless otherwise noted.

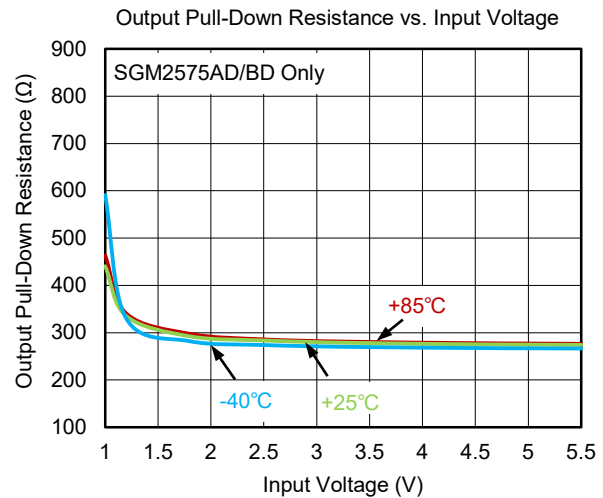
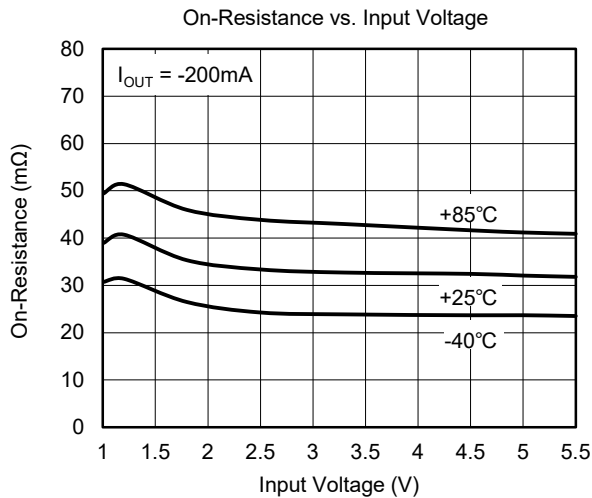
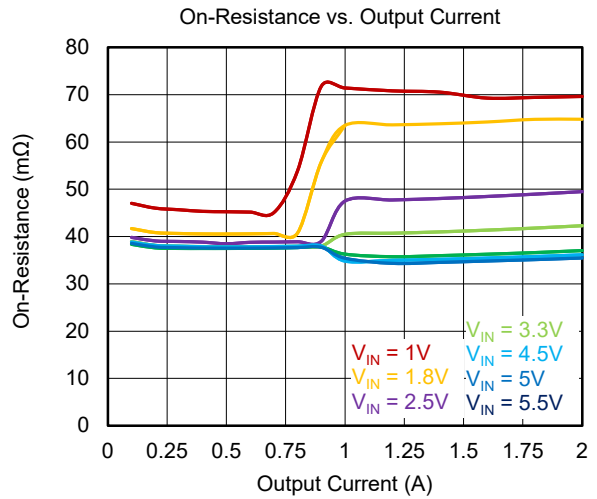
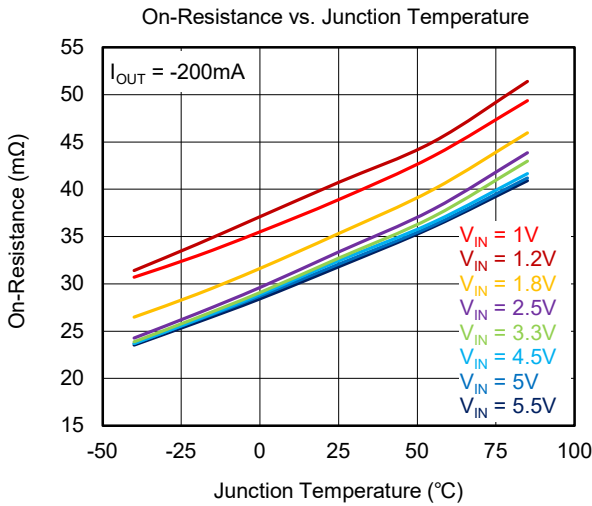
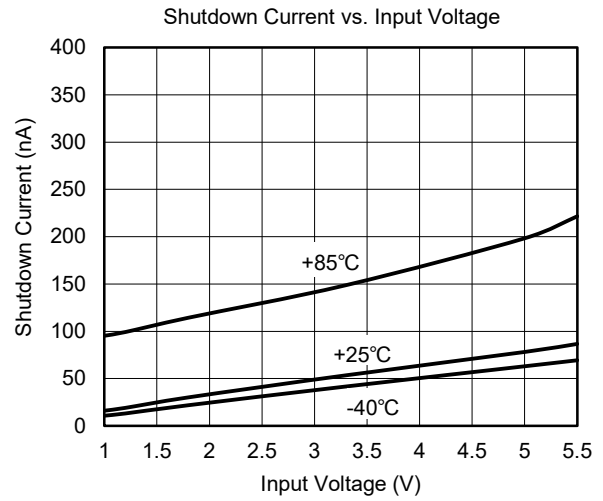
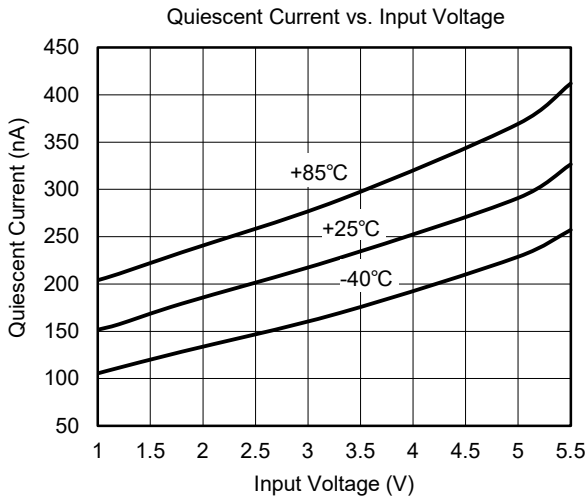

TYPICAL PERFORMANCE CHARACTERISTICS (continued)

T<sub>J</sub> = +25°C, C<sub>IN</sub> = 1μF, C<sub>OUT</sub> = 0.1μF, R<sub>OUT</sub> = 10Ω, V<sub>IH</sub> = 1.2V, V<sub>IL</sub> = 0V, unless otherwise noted.

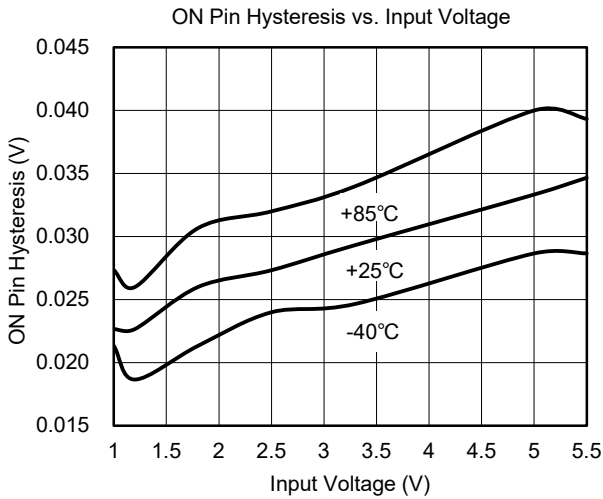
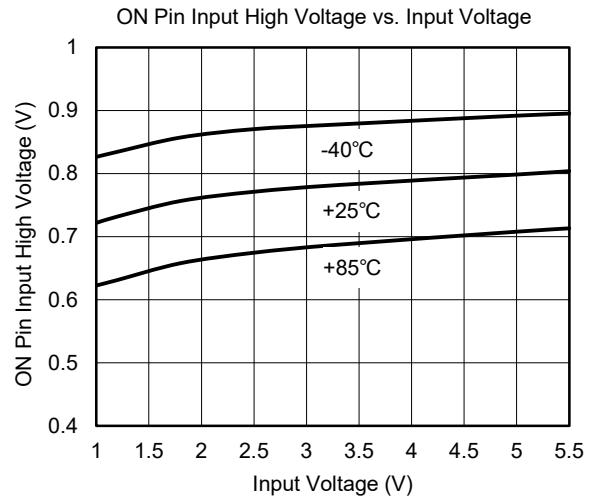
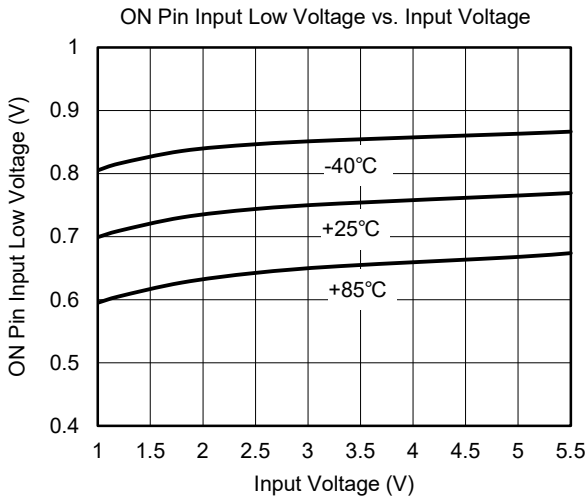

SGM2575A/SGM2575AD: TYPICAL PERFORMANCE CHARACTERISTICS

T<sub>J</sub> = +25°C, C<sub>IN</sub> = 1μF, C<sub>OUT</sub> = 0.1μF, R<sub>OUT</sub> = 10Ω, V<sub>IH</sub> = 1.2V, V<sub>IL</sub> = 0V, unless otherwise noted.

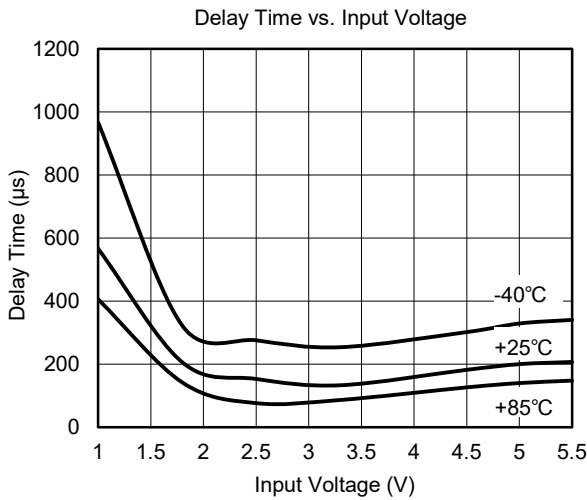
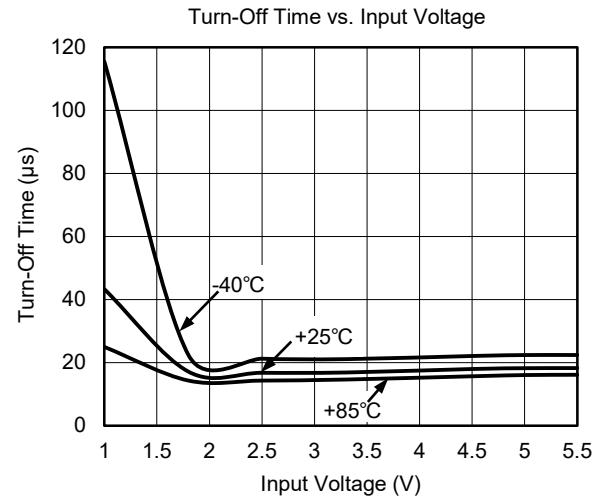
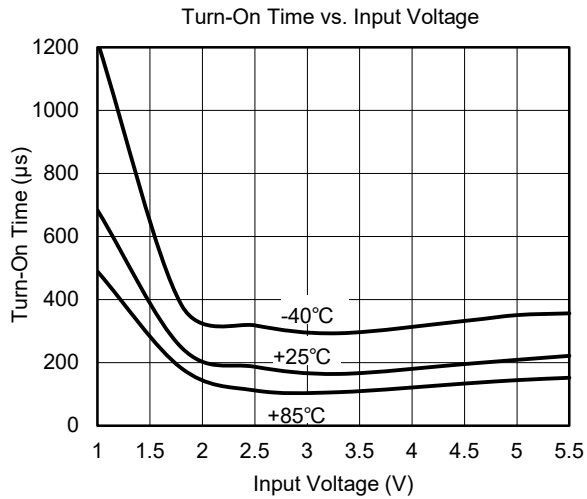
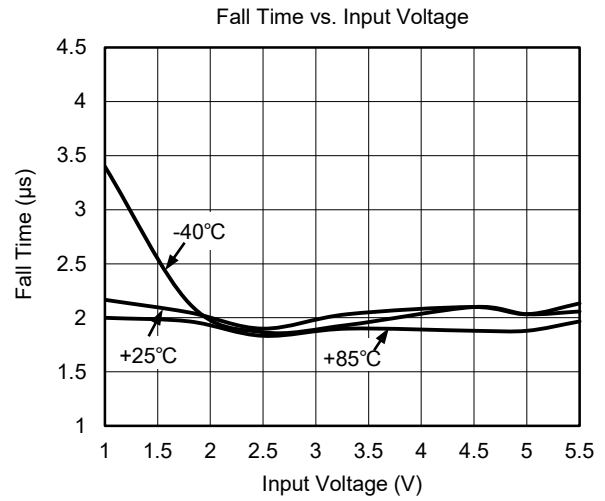
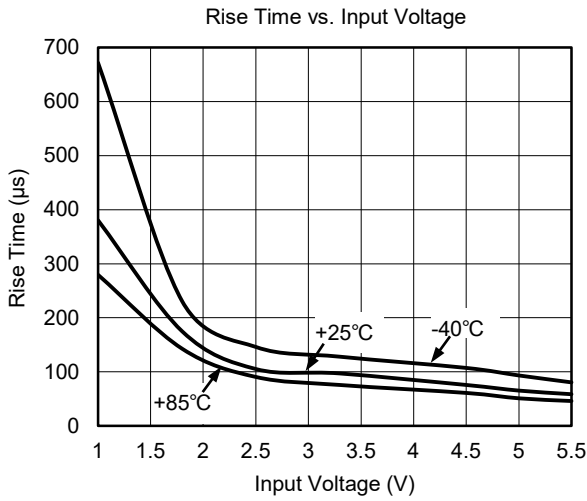



SGM2575A/SGM2575AD: TYPICAL PERFORMANCE CHARACTERISTICS (continued)

T<sub>J</sub> = +25°C, C<sub>IN</sub> = 1μF, C<sub>OUT</sub> = 0.1μF, R<sub>OUT</sub> = 10Ω, V<sub>IH</sub> = 1.2V, V<sub>IL</sub> = 0V, unless otherwise noted.

Turn-On Response

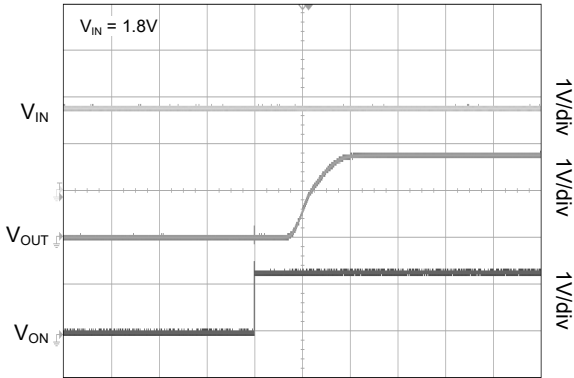

Time (200μs/div)

Turn-Off Response

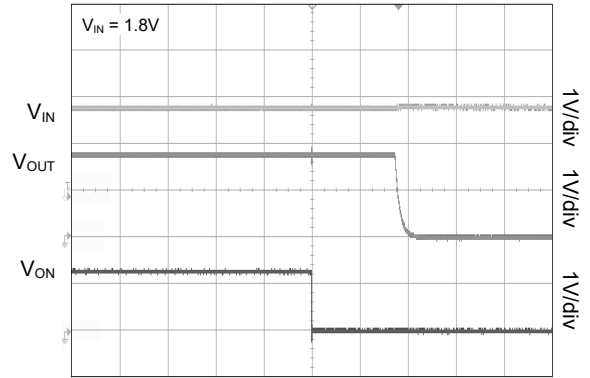

Time (10μs/div)

Turn-On Response

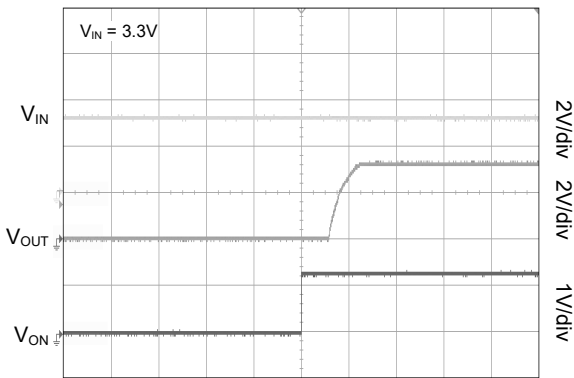

Time (200μs/div)

Turn-Off Response

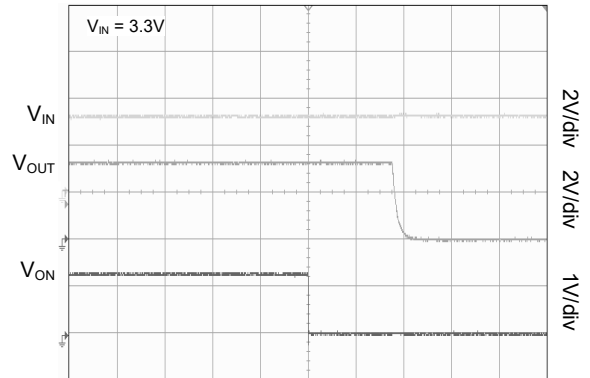

Time (10μs/div)

Turn-On Response

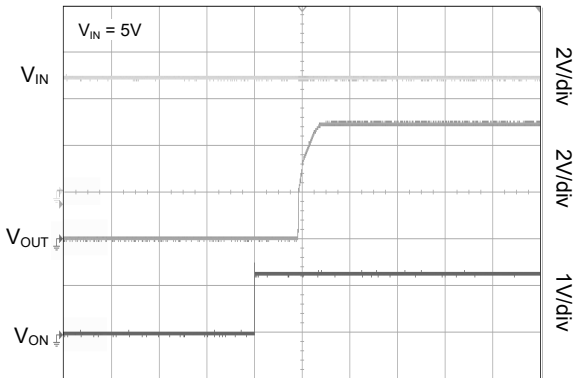

Time (200μs/div)

Turn-Off Response

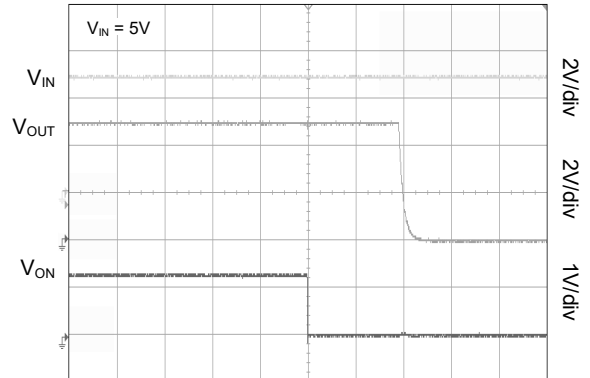

Time (10μs/div)

SGM2575BD: TYPICAL PERFORMANCE CHARACTERISTICS

T<sub>J</sub> = +25°C, C<sub>IN</sub> = 1μF, C<sub>OUT</sub> = 0.1μF, R<sub>OUT</sub> = 10Ω, V<sub>IH</sub> = 1.2V, V<sub>IL</sub> = 0V, unless otherwise noted.

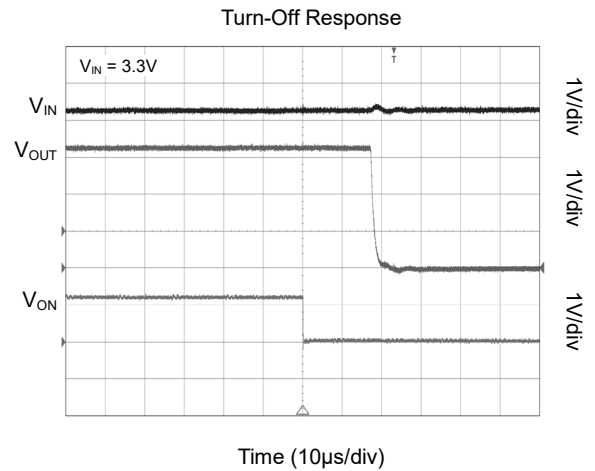
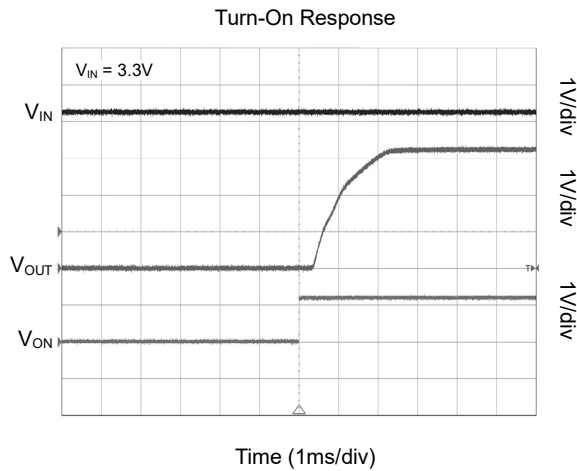
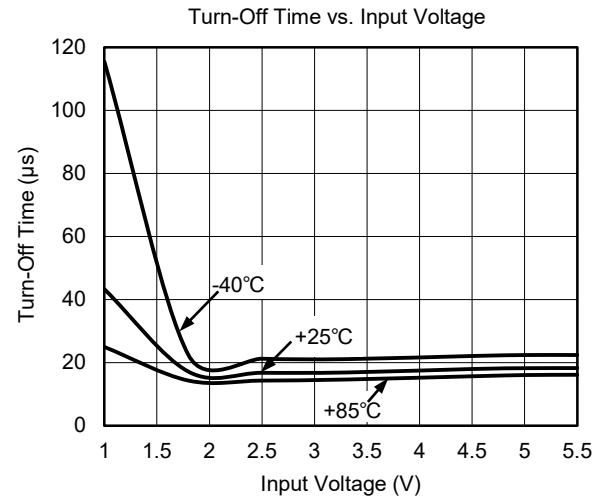
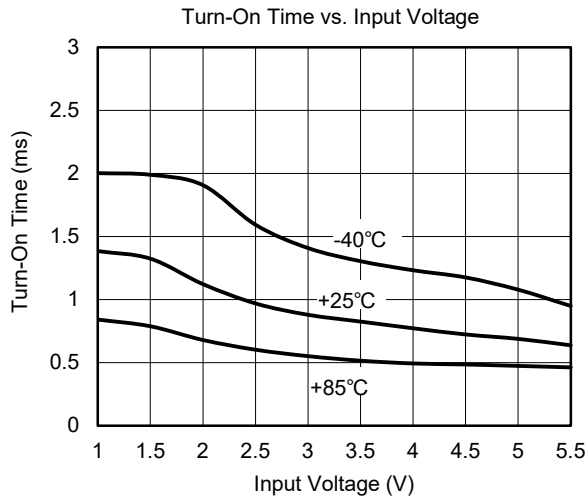
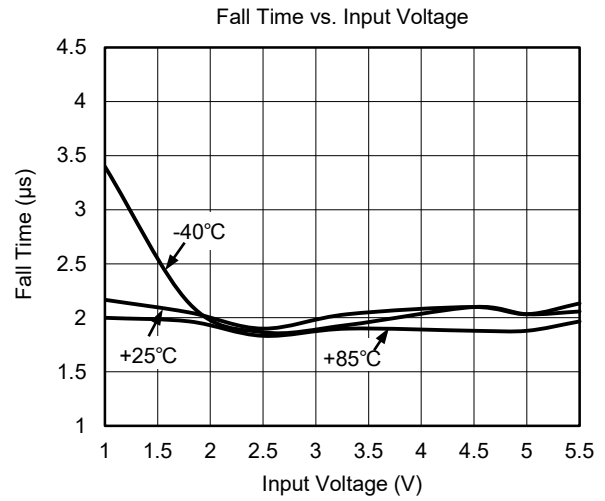
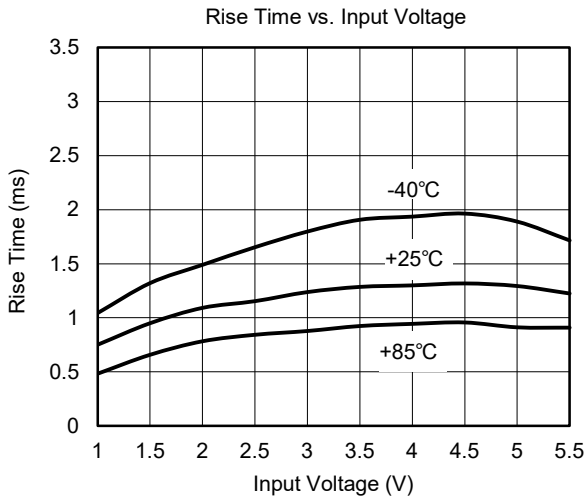

**DETAILED DESCRIPTION**

The SGM2575 is a small, 4-ball, 2A load switch. A low on-resistance N-MOSFET is integrated, which makes a low voltage drop across the device. To choose suitable rise time is always used to avoid inrush current.

**Control Pin**

The ON pin can control the device. Pulling the ON pin high enables the device. Logic high of V<sub>IH</sub> on the ON pin will enable the device and V<sub>IL</sub> will turn off it. It has the ability to interface with low-voltage GPIO. It can support with 1.8V, 2.5V, 3.3V GPIOs.

**Quick Output Discharge (SGM2575AD/SGM2575BD Only)**

The quick output discharge (QOD) feature is available for SGM2575AD and SGM2575BD. If the ON pin is pulled low, a discharge resistor of 270Ω (TYP) is

connected between VOUT and GND pins to prevent the output from floating when the switch is disabled.

**Functional Modes**

The connection of the VOUT pin is shown in Table 1. Table 2 shows the smart-ON functions.

**Table 1. VOUT Connection**

ON Pin	VOUT Pin
L	GND
H	VIN

**Table 2. Smart-ON Functional Modes**

ON	ON Pin
Below V <sub>IL</sub>	Pull-Down Active
Above V <sub>IH</sub>	No Pull-Down

**APPLICATION INFORMATION**

SGM2575 is a single channel, up to 2A current capability load switch with low on-resistance. The device has a wide input range, which can be used in different end equipment to set power sequence, reduce inrush current and maintain low standby leakage current. The typical application circuit of SGM2575 is shown in Figure 4.

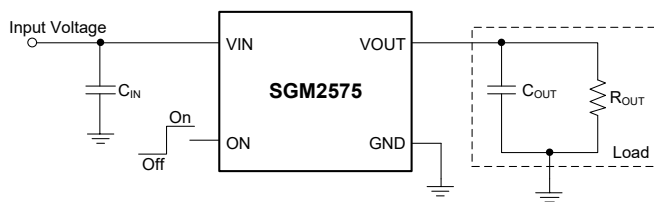

**Figure 4. Typical Application Circuit**

**Input Capacitor**

A 1μF input capacitor (C<sub>IN</sub>) is recommended to use between VIN and GND close to the device pins. It can limit the voltage drop on the input supply. Larger C<sub>IN</sub> can reduce voltage dip in high current applications.

**Output Capacitor**

A 0.1μF output capacitor (C<sub>OUT</sub>) should be placed between VOUT and GND close to the device pins. This capacitor will prevent parasitic board inductances from forcing V<sub>OUT</sub> below GND when the switch is turned off. To improve the V<sub>IN</sub> dropping when the device is turned on, it is recommended that C<sub>IN</sub> is placed greater than C<sub>OUT</sub>, due to the C<sub>IN</sub> is charge for C<sub>OUT</sub>.

APPLICATION INFORMATION (continued)

Reverse Current Protection

If the ON pin is pulled low, the device is disabled, while  $V_{IN} > 1V$  or  $V_{OUT} > 1V$  is met, the reverse current protection function is activated. This function prevents the current flowing from VOUT to VIN, and is very useful when SGM2575 is disabled and the output needs to be driven by another voltage source.

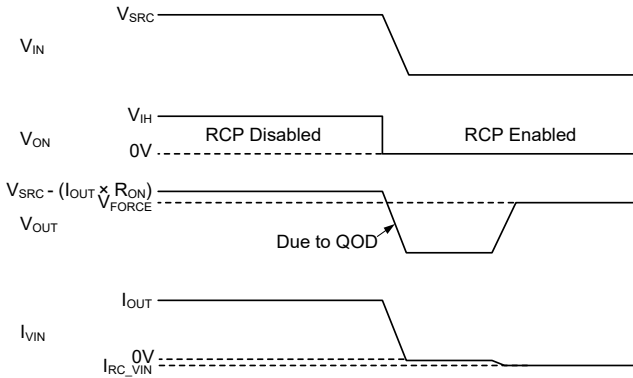

NOTES:  $V_{SRC}$  is the input power supply to the equipment.  $V_{FORCE}$  is the external power source forced at VOUT pin.  $I_{VIN}$  is the current of VIN pin.  $I_{OUT}$  is output load current.

Figure 5. Reverse Current Protection

Figure 5 shows how the reverse current protection circuit is activated in SGM2575. Pulling the ON pin down, the device is shut down and an external voltage ( $V_{FORCE}$ ) is forced to VOUT pin, the reverse current is tested very small given by  $I_{RC\_VIN}$ . This will prevent any large extra current reverse from the  $V_{FORCE}$  (added on  $V_{OUT}$ ) to  $V_{IN}$ .

Power Supply Recommendations

The SGM2575 is designed for a wide operate input voltage range of 1V to 5.5V. Place a 1μF input bypass capacitor close to the device terminal is recommended.

Power Supply Sequencing without a GPIO Input

In many terminal devices, each module needs to be powered up in a pre-determined manner. SGM2575 can set a power sequence by the  $t_{DELAY}$  without extra GPIO, and may reduce inrush current. Figure 6 shows the sequence that the ON pin of first load switch is tied to the VIN, and the second load switch ON pin is tied to the VOUT of first load switch. The second load switch is powered up when the first load switch is turned on, this is the fixed sequence and the delay time set by default  $t_{DELAY}$ .

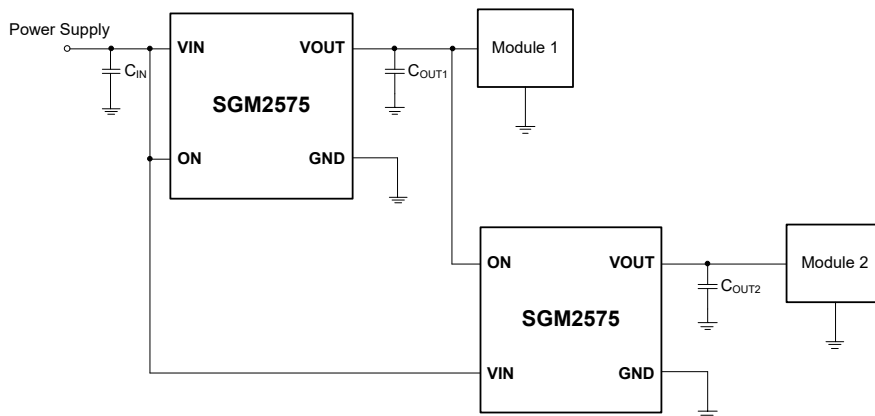

Figure 6. Power Supply Sequencing without a GPIO Input

**REVISION HISTORY**

NOTE: Page numbers for previous revisions may differ from page numbers in the current version.

<b>FEBRUARY 2022 – REV.A.1 to REV.A.2</b>	<b>Page</b>
Updated Absolute Maximum Ratings section.....	2
Updated Package Outline Dimensions section .....	14

---

<b>JULY 2020 – REV.A to REV.A.1</b>	<b>Page</b>
Added SGM2575A and SGM2575BD versions .....	All

---

<b>Changes from Original (JANUARY 2020) to REV.A</b>	<b>Page</b>
Changed from product preview to production data.....	All

---

PACKAGE OUTLINE DIMENSIONS

WLCSP-0.8x0.8-4B

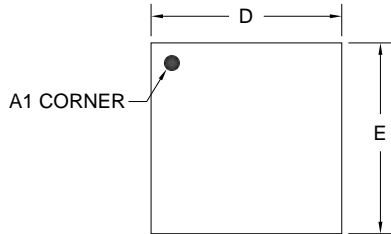

TOP VIEW

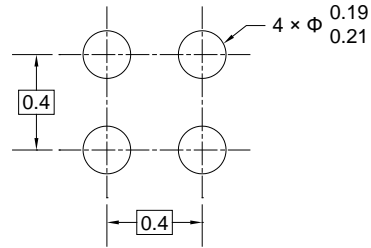

RECOMMENDED LAND PATTERN (Unit: mm)

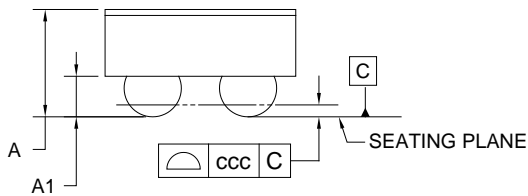

SIDE VIEW

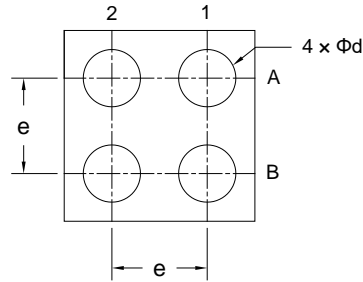

BOTTOM VIEW

Symbol	Dimensions In Millimeters		
	MIN	MOD	MAX
A	0.400	0.450	0.500
A1	0.145	0.170	0.195
D	0.770	0.800	0.830
E	0.770	0.800	0.830
d	0.215	0.240	0.265
ccc	-	0.050	-
e	0.400 BSC		

NOTE: This drawing is subject to change without notice.

# PACKAGE INFORMATION

## TAPE AND REEL INFORMATION

### REEL DIMENSIONS



### TAPE DIMENSIONS



NOTE: The picture is only for reference. Please make the object as the standard.

### KEY PARAMETER LIST OF TAPE AND REEL

Package Type	Reel Diameter	Reel Width W1 (mm)	A0 (mm)	B0 (mm)	K0 (mm)	P0 (mm)	P1 (mm)	P2 (mm)	W (mm)	Pin1 Quadrant
WLCSP-0.8×0.8-4B	7"	9.0	0.89	0.89	0.55	4.0	4.0	2.0	8.0	Q1

000001

# PACKAGE INFORMATION

## CARTON BOX DIMENSIONS



NOTE: The picture is only for reference. Please make the object as the standard.

## KEY PARAMETER LIST OF CARTON BOX

Reel Type	Length (mm)	Width (mm)	Height (mm)	Pizza/Carton
7" (Option)	368	227	224	8
7"	442	410	224	18

DD0002



单击下面可查看定价，库存，交付和生命周期等信息

[>>SGMICRO\(圣邦微电子\)](#)