



SGM48752X

CMOS Analog Multiplexer

GENERAL DESCRIPTION

The SGM48752X is a CMOS analog multiplexer which consists of two 4-channel multiplexers. It operates from 2.5V to 5.5V single power supply and all digital inputs support 1.8V logic control.

Other features include low voltage, low on-resistance and low off-leakage current. The high performances make it very suitable for multiple applications, such as cellular phones, audio and video signal routing, etc.

The SGM48752X is available in Green SOIC-16, SSOP-16, TSSOP-16 and TQFN-3×3-16L packages. It operates over an ambient temperature range of -40°C to +125°C.

FEATURES

- **Single Supply Voltage Range: 2.5V to 5.5V**
- **On-Resistance: 52Ω (TYP) with 5V Supply**
- **1.8V Logic Compatible**
- **Low On-Resistance Flatness**
- **Low Crosstalk: -85dB (f = 1MHz)**
- **High Off-Isolation: -70dB (R_L = 50Ω, f = 1MHz)**
- **Low Off-Leakage Current: ±1μA (MAX)**
- **Low On-Leakage Current: ±1μA (MAX)**
- **Low Distortion: 0.65% (R_L = 600Ω, f = 20Hz to 20kHz)**
- **-40°C to +125°C Operating Temperature Range**
- **Available in Green SOIC-16, SSOP-16, TSSOP-16 and TQFN-3×3-16L Packages**

APPLICATIONS

Automotive
Portable Equipment
Sample-and-Hold Circuits
Data-Acquisition Systems
Battery-Powered Systems
Audio and Video Signal Routing

PACKAGE/ORDERING INFORMATION

MODEL	PACKAGE DESCRIPTION	SPECIFIED TEMPERATURE RANGE	ORDERING NUMBER	PACKAGE MARKING	PACKING OPTION
SGM48752X	SOIC-16	-40°C to +125°C	SGM48752XS16G/TR	SGM48752XS16 XXXXX	Tape and Reel, 2500
	SSOP-16	-40°C to +125°C	SGM48752XQS16G/TR	SGM48752 XQS16 XXXXX	Tape and Reel, 4000
	TSSOP-16	-40°C to +125°C	SGM48752XTS16G/TR	SGM48752 XTS16 XXXXX	Tape and Reel, 4000
	TQFN-3x3-16L	-40°C to +125°C	SGM48752XTQ16G/TR	48752TQ XXXXX	Tape and Reel, 4000

MARKING INFORMATION

NOTE: XXXXX = Date Code, Trace Code and Vendor Code.

SOIC-16/SSOP-16/TSSOP-16/TQFN-3x3-16L

XXXXX

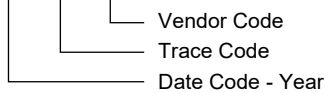

Green (RoHS & HSF): SG Micro Corp defines "Green" to mean Pb-Free (RoHS compatible) and free of halogen substances. If you have additional comments or questions, please contact your SGMICRO representative directly.

ABSOLUTE MAXIMUM RATINGS

- V_{CC} to GND -0.3V to 6V
- Voltage into Any Terminal ⁽¹⁾ -0.3V to (V_{CC} + 0.3V)
- Continuous Current into Any Terminal ±20mA
- Peak Current, X₋, Y₋
(Pulsed at 1ms, 10% duty cycle) ±40mA
- Junction Temperature +150°C
- Storage Temperature Range -65°C to +150°C
- Lead Temperature (Soldering, 10s) +260°C
- ESD Susceptibility
- HBM 4000V
- CDM 1000V

NOTE:

1. Internal diodes will clamp the voltage on any signal that is lower than GND. Limit the current through the forward diode to the maximum ratings.

RECOMMENDED OPERATING CONDITIONS

- Supply Voltage Range 2.5V to 5.5V
- Operating Temperature Range -40°C to +125°C

OVERSTRESS CAUTION

Stresses beyond those listed in Absolute Maximum Ratings may cause permanent damage to the device. Exposure to absolute maximum rating conditions for extended periods may affect reliability. Functional operation of the device at any conditions beyond those indicated in the Recommended Operating Conditions section is not implied.

ESD SENSITIVITY CAUTION

This integrated circuit can be damaged if ESD protections are not considered carefully. SGMICRO recommends that all integrated circuits be handled with appropriate precautions. Failure to observe proper handling and installation procedures can cause damage. ESD damage can range from subtle performance degradation to complete device failure. Precision integrated circuits may be more susceptible to damage because even small parametric changes could cause the device not to meet the published specifications.

DISCLAIMER

SG Micro Corp reserves the right to make any change in circuit design, or specifications without prior notice.

PIN CONFIGURATIONS

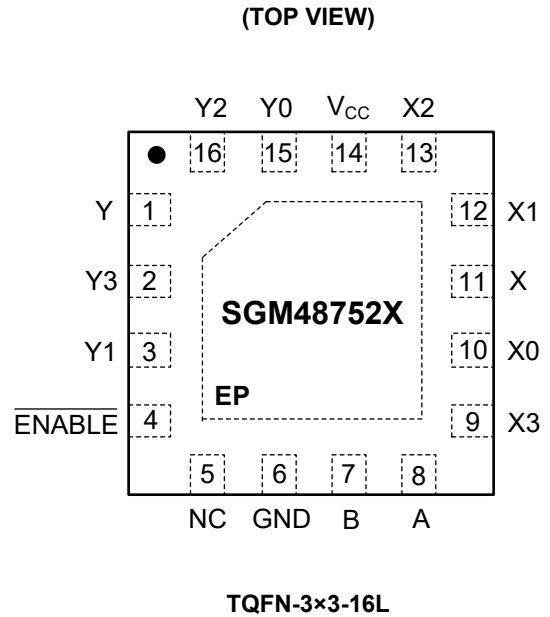
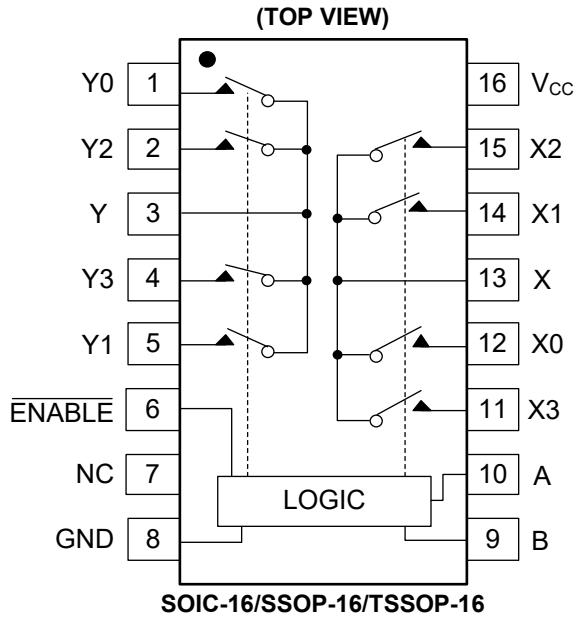

PIN DESCRIPTION

PIN		NAME	FUNCTION
SOIC-16/SSOP-16/TSSOP-16	TQFN-3x3-16L		
1, 5, 2, 4	15, 3, 16, 2	Y0, Y1, Y2, Y3	Analog Switch "Y" Inputs 0-3.
3	1	Y	Analog Switch "Y" Output Pin.
6	4	ENABLE	Digital Enable Control Pin. Normally connected to GND.
7	5	NC	No Connection.
8	6	GND	Ground. Connect to digital ground.
9	7	B	Digital Signal Input B Pin.
10	8	A	Digital Signal Input A Pin.
12, 14, 15, 11	10, 12, 13, 9	X0, X1, X2, X3	Analog Switch "X" Inputs 0-3.
13	11	X	Analog Switch "X" Output Pin.
16	14	V _{CC}	Positive Analog and Digital Supply Voltage Input Pin.
—	Exposed Pad	EP	Exposed Pad. Connect exposed pad to GND.

NOTE:

Any input pin can be used as an output pin, and any output pin can also be used as an input pin. Signal transmission in both directions is equally well.

PACKAGE OUTLINE DIMENSIONS

SOIC-16

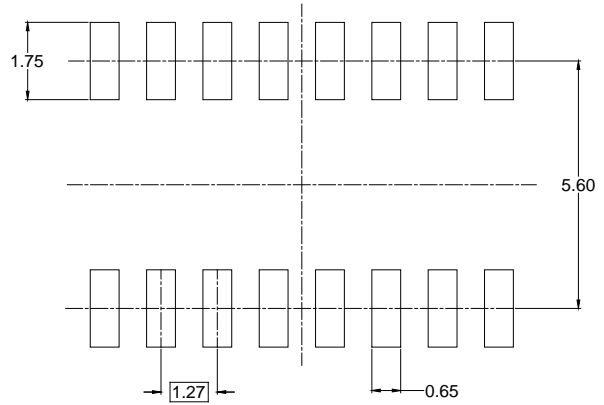
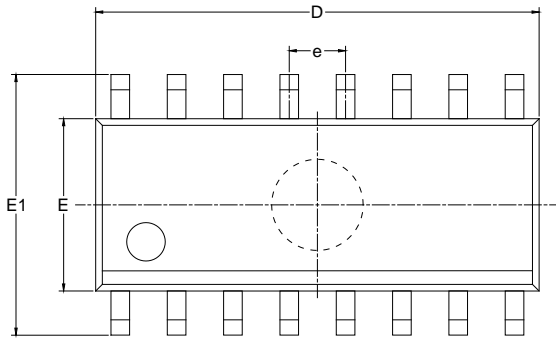

RECOMMENDED LAND PATTERN (Unit: mm)

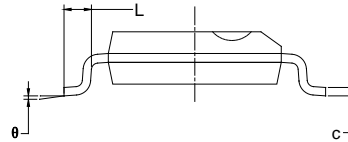
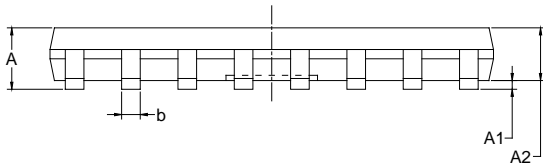

Symbol	Dimensions In Millimeters		Dimensions In Inches	
	MIN	MAX	MIN	MAX
A	1.350	1.750	0.053	0.069
A1	0.100	0.250	0.004	0.010
A2	1.350	1.550	0.053	0.061
b	0.330	0.510	0.013	0.020
c	0.170	0.250	0.006	0.010
D	9.800	10.200	0.386	0.402
E	3.800	4.000	0.150	0.157
E1	5.800	6.200	0.228	0.244
e	1.27 BSC		0.050 BSC	
L	0.400	1.270	0.016	0.050
θ	0°	8°	0°	8°

NOTES:

1. Body dimensions do not include mode flash or protrusion.
2. This drawing is subject to change without notice.

PACKAGE OUTLINE DIMENSIONS

SSOP-16

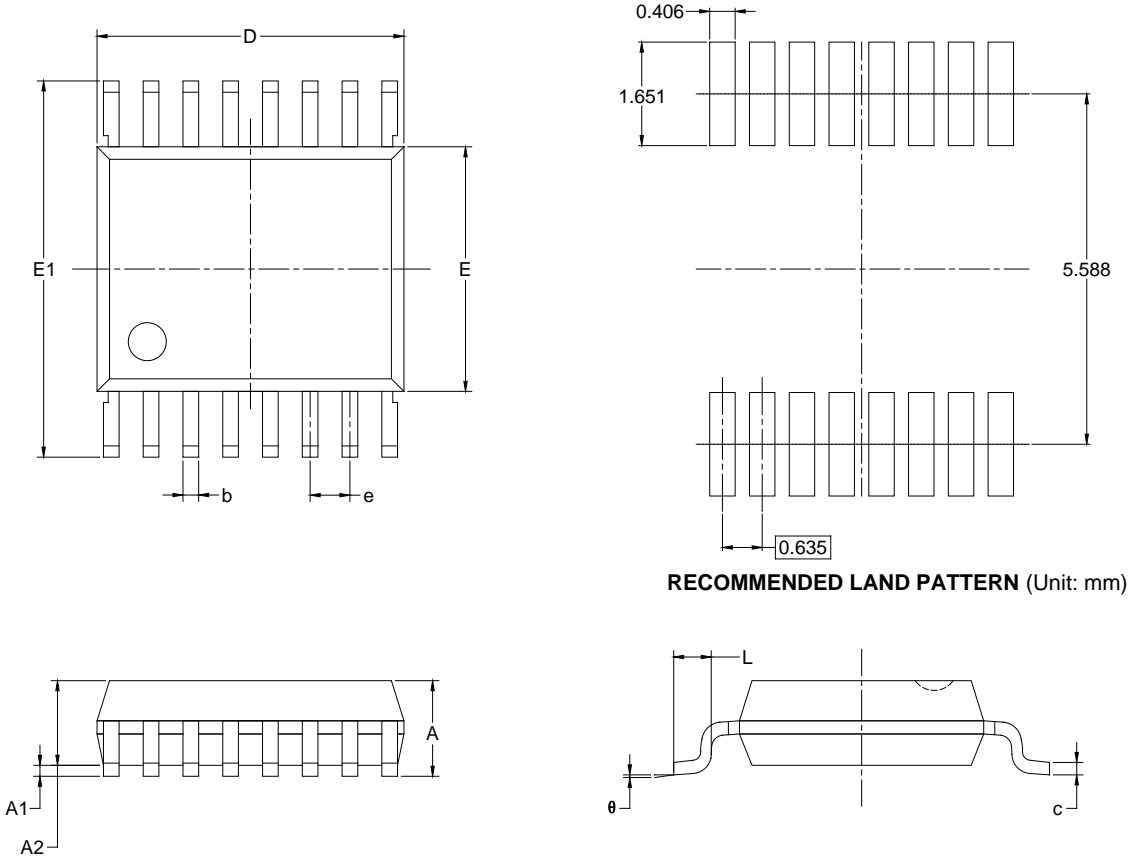

RECOMMENDED LAND PATTERN (Unit: mm)

Symbol	Dimensions In Millimeters		Dimensions In Inches	
	MIN	MAX	MIN	MAX
A	1.350	1.750	0.053	0.069
A1	0.100	0.250	0.004	0.010
A2	1.350	1.550	0.053	0.061
b	0.200	0.300	0.008	0.012
c	0.170	0.250	0.007	0.010
D	4.700	5.100	0.185	0.200
E	3.800	4.000	0.150	0.157
E1	5.800	6.200	0.228	0.244
e	0.635 BSC		0.025 BSC	
L	0.400	1.270	0.016	0.050
θ	0°	8°	0°	8°

NOTES:
 1. Body dimensions do not include mode flash or protrusion.
 2. This drawing is subject to change without notice.

PACKAGE OUTLINE DIMENSIONS

TSSOP-16

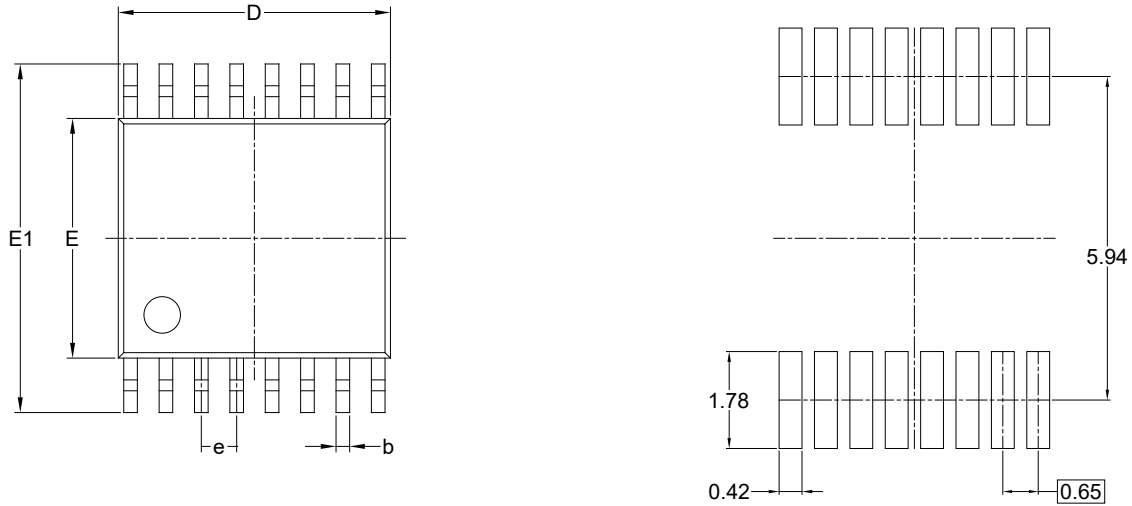

RECOMMENDED LAND PATTERN (Unit: mm)

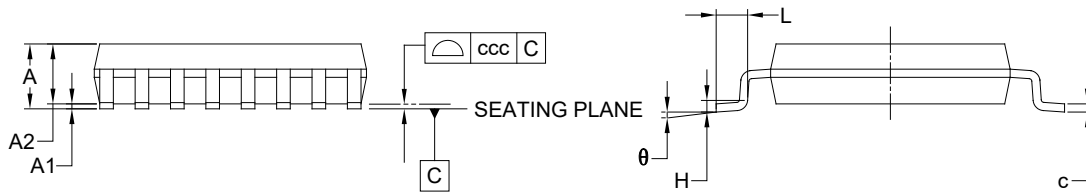

Symbol	Dimensions In Millimeters		
	MIN	MOD	MAX
A	-	-	1.200
A1	0.050	-	0.150
A2	0.800	-	1.050
b	0.190	-	0.300
c	0.090	-	0.200
D	4.860	-	5.100
E	4.300	-	4.500
E1	6.200	-	6.600
e	0.650 BSC		
L	0.450	-	0.750
H	0.250 TYP		
θ	0°	-	8°
ccc	0.100		

NOTES:

1. This drawing is subject to change without notice.
2. The dimensions do not include mold flashes, protrusions or gate burrs.
3. Reference JEDEC MO-153.

PACKAGE OUTLINE DIMENSIONS

TQFN-3x3-16L

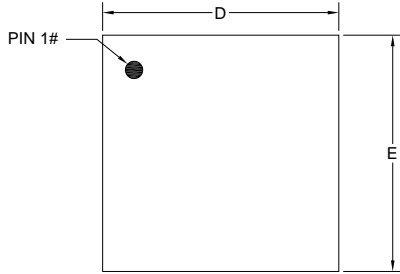

TOP VIEW

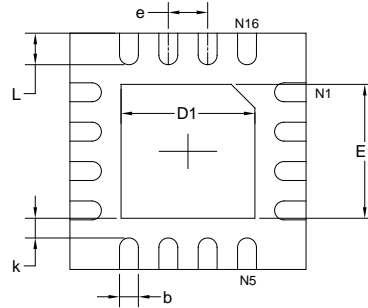

BOTTOM VIEW

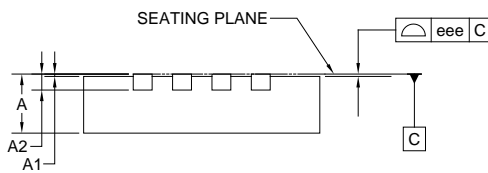

SIDE VIEW

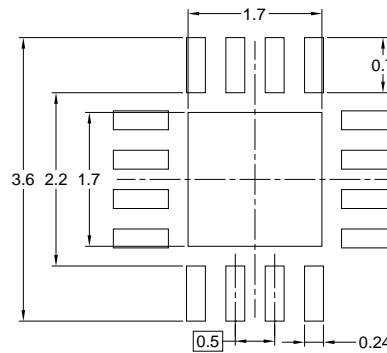

RECOMMENDED LAND PATTERN (Unit: mm)

Symbol	Dimensions In Millimeters		Dimensions In Inches	
	MIN	MAX	MIN	MAX
A	0.700	0.800	0.028	0.031
A1	0.000	0.050	0.000	0.002
A2	0.203 REF		0.008 REF	
D	2.900	3.100	0.114	0.122
D1	1.600	1.800	0.063	0.071
E	2.900	3.100	0.114	0.122
E1	1.600	1.800	0.063	0.071
k	0.200 MIN		0.008 MIN	
b	0.180	0.300	0.007	0.012
e	0.500 TYP		0.020 TYP	
L	0.300	0.500	0.012	0.020
eee	0.080		0.003	

NOTE: This drawing is subject to change without notice.

PACKAGE INFORMATION

TAPE AND REEL INFORMATION

REEL DIMENSIONS

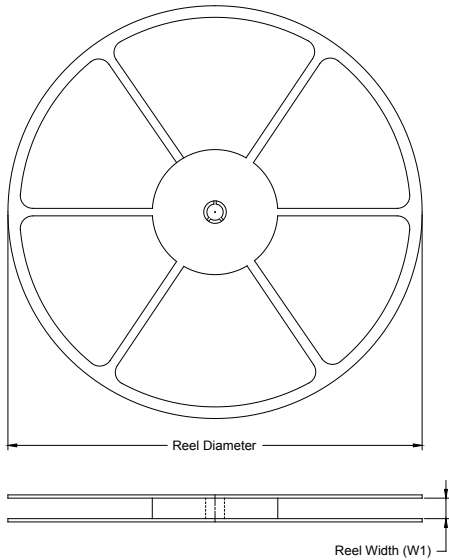

TAPE DIMENSIONS

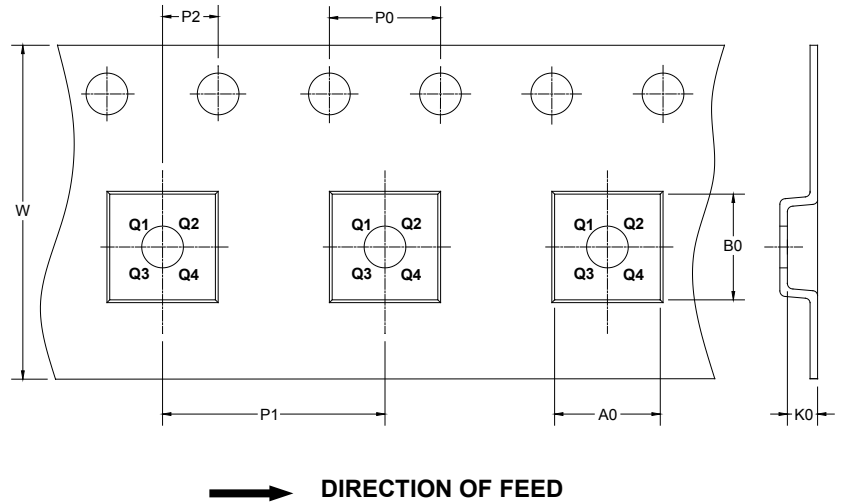

NOTE: The picture is only for reference. Please make the object as the standard.

KEY PARAMETER LIST OF TAPE AND REEL

Package Type	Reel Diameter	Reel Width W1 (mm)	A0 (mm)	B0 (mm)	K0 (mm)	P0 (mm)	P1 (mm)	P2 (mm)	W (mm)	Pin1 Quadrant
SOIC-16	13"	16.4	6.50	10.30	2.10	4.0	8.0	2.0	16.0	Q1
SSOP-16	13"	12.4	6.40	5.40	2.10	4.0	8.0	2.0	12.0	Q1
TSSOP-16	13"	12.4	6.80	5.40	1.50	4.0	8.0	2.0	12.0	Q1
TQFN-3×3-16L	13"	12.4	3.35	3.35	1.13	4.0	8.0	2.0	12.0	Q2

DD0001

PACKAGE INFORMATION

CARTON BOX DIMENSIONS



NOTE: The picture is only for reference. Please make the object as the standard.

KEY PARAMETER LIST OF CARTON BOX

Reel Type	Length (mm)	Width (mm)	Height (mm)	Pizza/Carton
13"	386	280	370	5

DD0002

单击下面可查看定价，库存，交付和生命周期等信息

[>>SGMICRO\(圣邦微电子\)](#)