



SGM8541/SGM8542/SGM8544 1.1MHz, 46 μ A, Rail-to-Rail I/O, CMOS Operational Amplifiers

GENERAL DESCRIPTION

The SGM8541 (single), SGM8542 (dual) and SGM8544 (quad) are low cost, voltage feedback amplifiers. These devices can operate from 2.1V to 5.5V single supply, while consuming only 46 μ A quiescent current per amplifier. They provide rail-to-rail input with a wide input common mode voltage range and rail-to-rail output voltage swing. This feature makes SGM8541/2/4 appropriate for buffering ASIC.

The SGM8541/2/4 offer a gain-bandwidth product of 1.1MHz and an ultra-low input bias current of 0.5pA. They are well suited for piezoelectric sensors, integrators and photodiode amplifiers.

The SGM8541/2/4 are designed into a wide range of applications, such as battery-powered instrumentation, safety monitoring, portable systems, and transducer interface circuits in low power systems.

The SGM8541 is available in Green SOT-23-5, SC70-5 and SOIC-8 packages. The SGM8542 is available in Green SOIC-8, MSOP-8 and TSSOP-8 packages. The SGM8544 is available in Green TSSOP-14 and SOIC-14 packages. They are specified over the extended industrial temperature range (-40°C to +125°C).

FEATURES

- **Low Cost**
- **Input Offset Voltage: 3.5mV (MAX)**
- **Very Low Input Bias Current: 0.5pA**
- **Unity-Gain Stable**
- **Gain-Bandwidth Product: 1.1MHz**
- **Rail-to-Rail Input and Output**
- **Supply Voltage Range: 2.1V to 5.5V**
- **Input Voltage Range:**
-0.1V to 5.6V with $V_S = 5.5V$
- **Low Supply Current: 46 μ A/Amplifier**
- **-40°C to +125°C Operating Temperature Range**
- **Small Packaging:**
SGM8541 Available in Green SOIC-8, SC70-5 and SOT-23-5 Packages
SGM8542 Available in Green SOIC-8, MSOP-8 and TSSOP-8 Packages
SGM8544 Available in Green SOIC-14 and TSSOP-14 Packages

APPLICATIONS

ASIC Input or Output Amplifiers
Piezoelectric Transducer Amplifiers
Battery-Powered Equipment
Portable Systems
Sensor Interfaces
Medical Instrumentation
Mobile Communications
Audio Outputs
Smoke Detectors
Mobile Telephones
Notebook PCs
PCMCIA Cards

PACKAGE/ORDERING INFORMATION

MODEL	PACKAGE DESCRIPTION	SPECIFIED TEMPERATURE RANGE	ORDERING NUMBER	PACKAGE MARKING	PACKING OPTION
SGM8541	SC70-5	-40°C to +125°C	SGM8541XC5/TR	8541	Tape and Reel, 3000
	SOT-23-5	-40°C to +125°C	SGM8541XN5/TR	8541	Tape and Reel, 3000
	SOIC-8	-40°C to +125°C	SGM8541XS/TR	SGM8541XS XXXXX	Tape and Reel, 2500
SGM8542	SOIC-8	-40°C to +125°C	SGM8542XS/TR	SGM8542XS XXXXX	Tape and Reel, 4000
	MSOP-8	-40°C to +125°C	SGM8542XMS/TR	SGM8542 XMS XXXXX	Tape and Reel, 3000
	TSSOP-8	-40°C to +125°C	SGM8542XTS8G/TR	SGM8542 XTS8 XXXXX	Tape and Reel, 4000
SGM8544	SOIC-14	-40°C to +125°C	SGM8544XS14/TR	SGM8544XS14 XXXXX	Tape and Reel, 2500
	TSSOP-14	-40°C to +125°C	SGM8544XTS14/TR	SGM8544 XTS14 XXXXX	Tape and Reel, 4000

MARKING INFORMATION

NOTE: XXXXX = Date Code and Vendor Code.

XXXXX

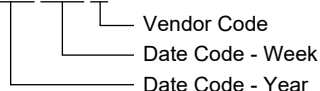

Green (RoHS & HSF): SG Micro Corp defines "Green" to mean Pb-Free (RoHS compatible) and free of halogen substances. If you have additional comments or questions, please contact your SGMICRO representative directly.

ABSOLUTE MAXIMUM RATINGS

Supply Voltage, +Vs to -Vs6V
 Input Common Mode Voltage Range
 (-Vs) - 0.3V to (+Vs) + 0.3V
 Package Thermal Resistance @ TA = +25°C
 SC70-5, θJA 333°C/W
 SOT-23-5, θJA 190°C/W
 SOIC-8, θJA 125°C/W
 MSOP-8, θJA 216°C/W
 TSSOP-8, θJA 175°C/W
 Junction Temperature+150°C
 Storage Temperature Range-65°C to +150°C
 Lead Temperature (Soldering, 10s)+260°C
 ESD Susceptibility
 HBM 4000V
 MM 400V

RECOMMENDED OPERATING CONDITIONS

Operating Temperature Range-40°C to +125°C

OVERSTRESS CAUTION

Stresses beyond those listed in Absolute Maximum Ratings may cause permanent damage to the device. Exposure to absolute maximum rating conditions for extended periods may affect reliability. Functional operation of the device at any conditions beyond those indicated in the Recommended Operating Conditions section is not implied.

ESD SENSITIVITY CAUTION

This integrated circuit can be damaged if ESD protections are not considered carefully. SGMICRO recommends that all integrated circuits be handled with appropriate precautions. Failure to observe proper handling and installation procedures can cause damage. ESD damage can range from subtle performance degradation to complete device failure. Precision integrated circuits may be more susceptible to damage because even small parametric changes could cause the device not to meet the published specifications.

DISCLAIMER

SG Micro Corp reserves the right to make any change in circuit design, or specifications without prior notice.

PIN CONFIGURATIONS

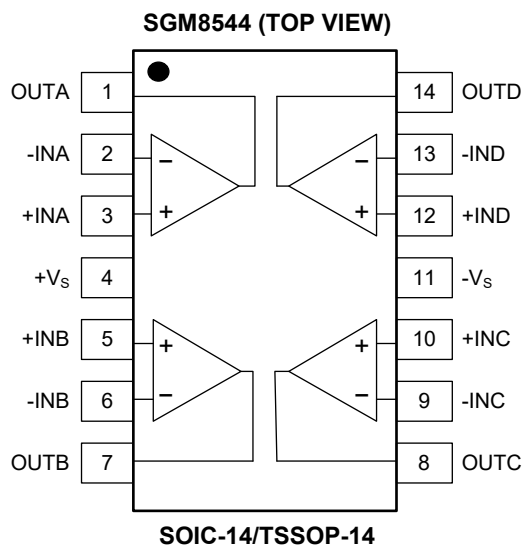
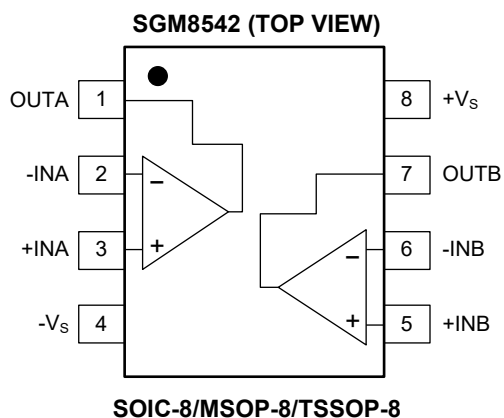
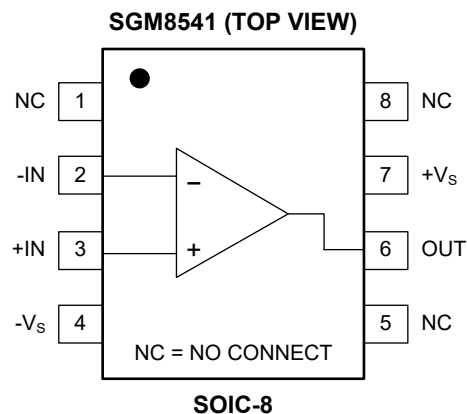
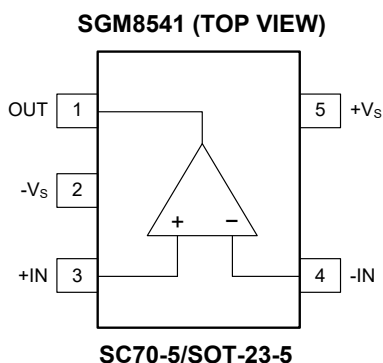

ELECTRICAL CHARACTERISTICS

(At $V_S = 5V$, $R_L = 100k\Omega$ connected to $V_S/2$ and $V_{OUT} = V_S/2$, unless otherwise noted.)

PARAMETER	SYMBOL	CONDITIONS	SGM8541/2/4					
			TYP	MIN/MAX OVER TEMPERATURE			UNITS	MIN/MAX
			+25°C	+25°C	-40°C to +125°C			
Input Characteristics								
Input Offset Voltage	V_{OS}	$V_{CM} = V_S/2$	0.8	3.5		mV	MAX	
Input Bias Current	I_B		0.5			pA	TYP	
Input Offset Current	I_{OS}		0.5			pA	TYP	
Input Common Mode Voltage Range	V_{CM}	$V_S = 5.5V$	-0.1 to 5.6			V	TYP	
Common Mode Rejection Ratio	CMRR	$V_S = 5.5V, V_{CM} = -0.1V$ to 4V	87	71	69	dB	MIN	
		$V_S = 5.5V, V_{CM} = -0.1V$ to 5.6V	80	60	56			
Open-Loop Voltage Gain	A_{OL}	$R_L = 5k\Omega, V_{OUT} = 0.1V$ to 4.9V	98	80	73	dB	MIN	
		$R_L = 100k\Omega, V_{OUT} = 0.035V$ to 4.965V	105	85	74			
Input Offset Voltage Drift	$\Delta V_{OS}/\Delta T$		2.7			$\mu V/^\circ C$	TYP	
Output Characteristics								
Output Voltage Swing from Rail	V_{OH}	$R_L = 100k\Omega$	4.997	4.980	4.970	V	MIN	
	V_{OL}	$R_L = 100k\Omega$	5	20	30	mV	MAX	
	V_{OH}	$R_L = 10k\Omega$	4.992	4.970	4.960	V	MIN	
	V_{OL}	$R_L = 10k\Omega$	8	30	40	mV	MAX	
Output Current	I_{SOURCE}	$R_L = 10\Omega$ to $V_S/2$	85	60	45	mA	MIN	
	I_{SINK}		75	60	45			
Power Supply								
Operating Voltage Range				2.1	2.5	V	MIN	
				5.5	5.5	V	MAX	
Power Supply Rejection Ratio	PSRR	$V_S = 2.5V$ to 5.5V, $V_{CM} = 0.5V$	87	70	64	dB	MIN	
Quiescent Current/Amplifier	I_Q		46	69	89	μA	MAX	
Dynamic Performance ($C_L = 100pF$)								
Gain-Bandwidth Product	GBP		1.1			MHz	TYP	
Slew Rate	SR	$G = +1, 2V$ Output Step	0.52			V/ μs	TYP	
Settling Time to 0.1%	t_s	$G = +1, 2V$ Output Step	5.3			μs	TYP	
Overload Recovery Time		$V_{IN} \cdot G = V_S$	2.6			μs	TYP	
Noise Performance								
Input Voltage Noise Density	e_n	$f = 1kHz$	27			nV/\sqrt{Hz}	TYP	
		$f = 10kHz$	20			nV/\sqrt{Hz}	TYP	

TYPICAL PERFORMANCE CHARACTERISTICS

At $T_A = +25^\circ\text{C}$, $V_S = 5\text{V}$, and $R_L = 100\text{k}\Omega$ connected to $V_S/2$, unless otherwise noted.

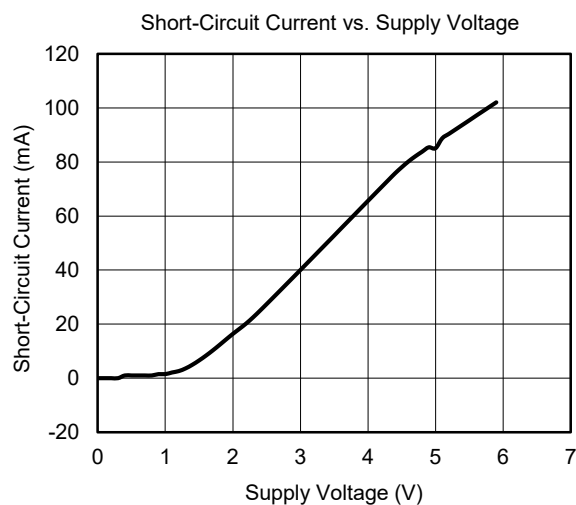
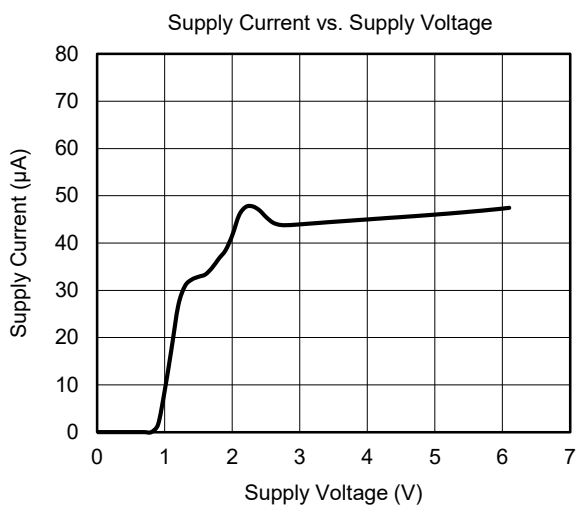
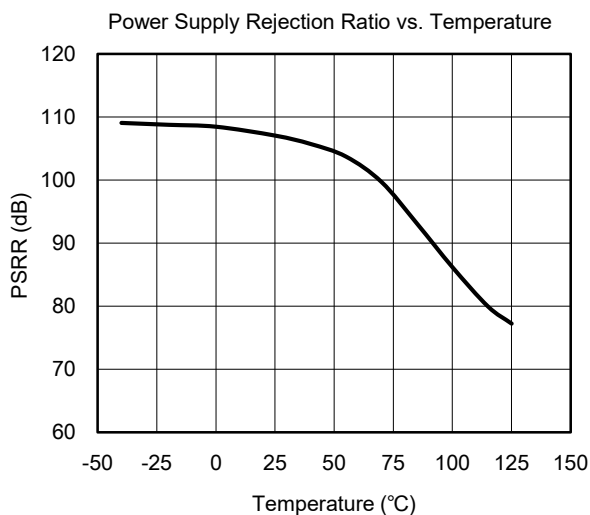
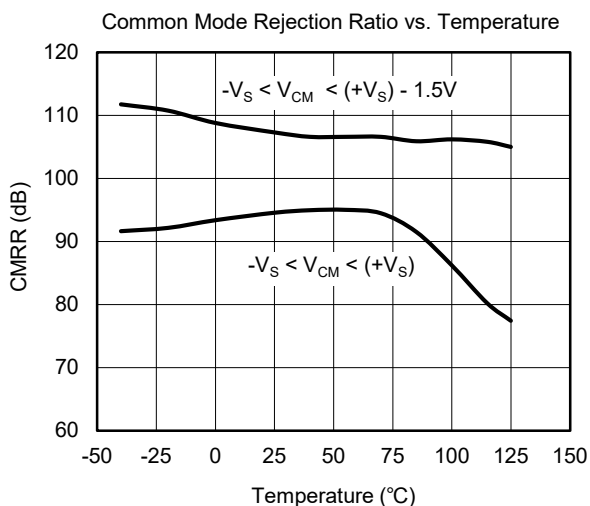
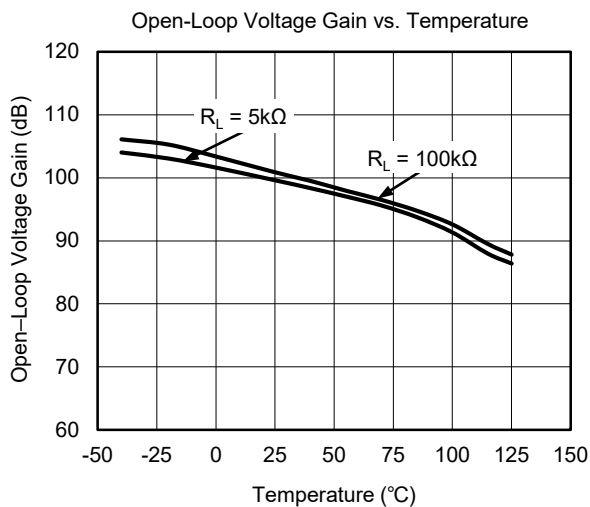
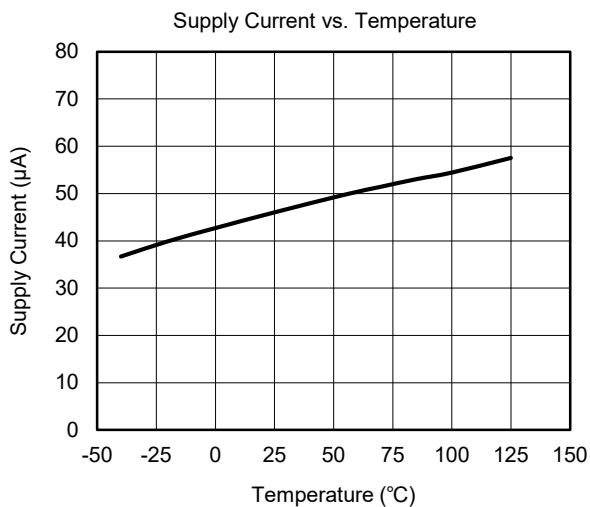

TYPICAL PERFORMANCE CHARACTERISTICS (continued)

At $T_A = +25^\circ\text{C}$, $V_S = 5\text{V}$, and $R_L = 100\text{k}\Omega$ connected to $V_S/2$, unless otherwise noted.

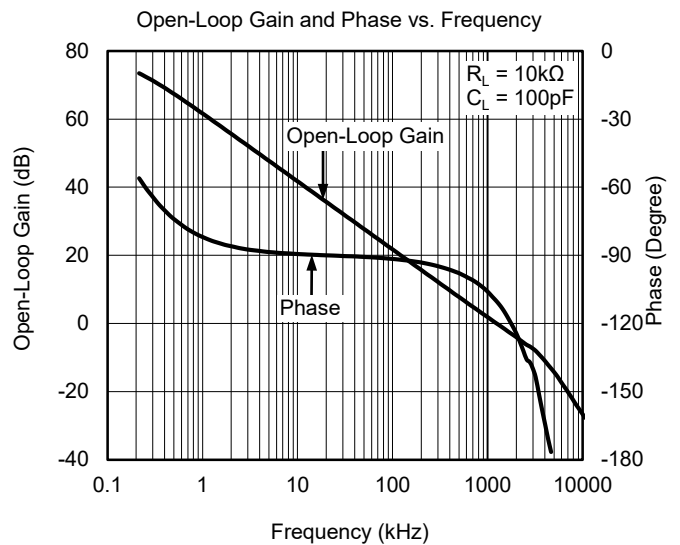
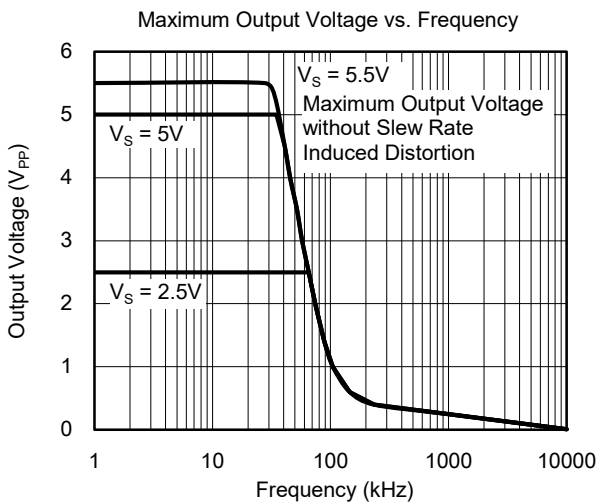
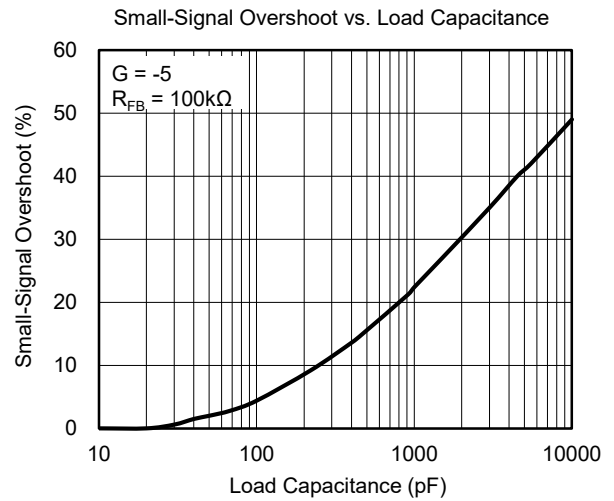
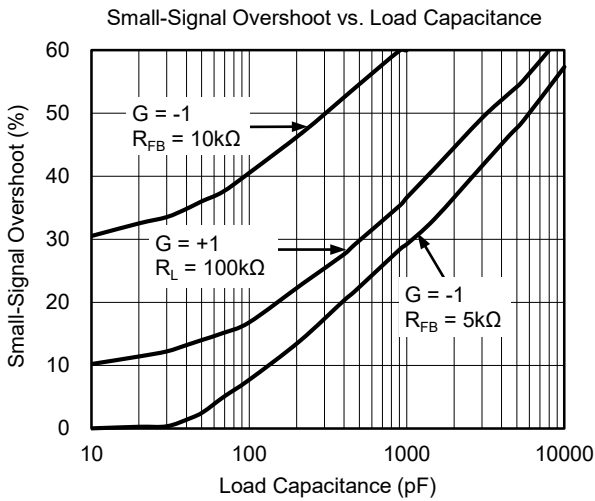
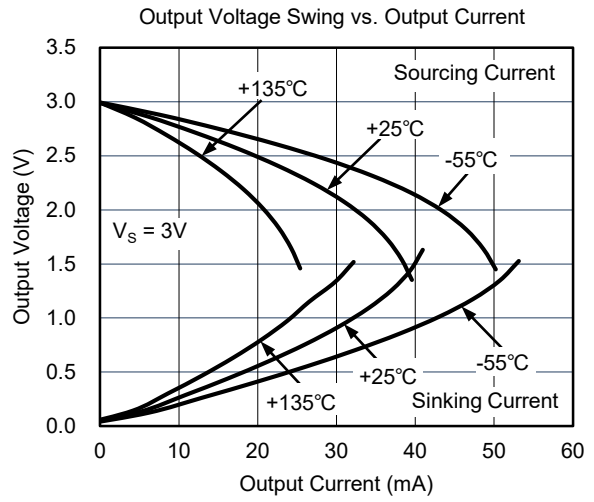
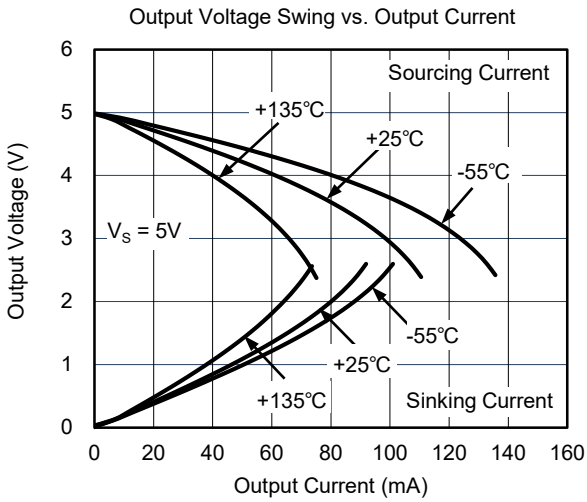

TYPICAL PERFORMANCE CHARACTERISTICS (continued)

At $T_A = +25^\circ\text{C}$, $V_S = 5\text{V}$, and $R_L = 100\text{k}\Omega$ connected to $V_S/2$, unless otherwise noted.

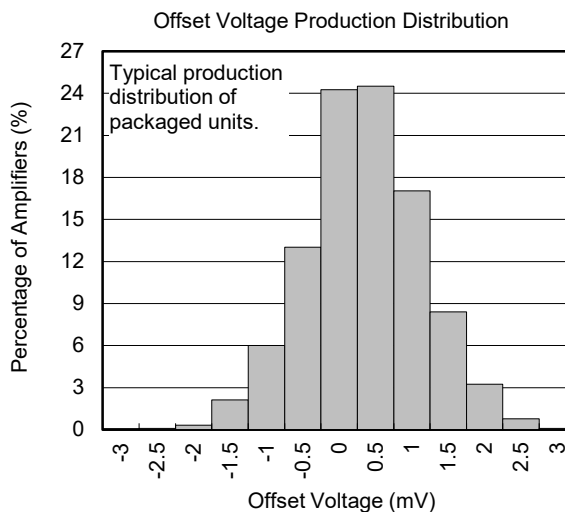
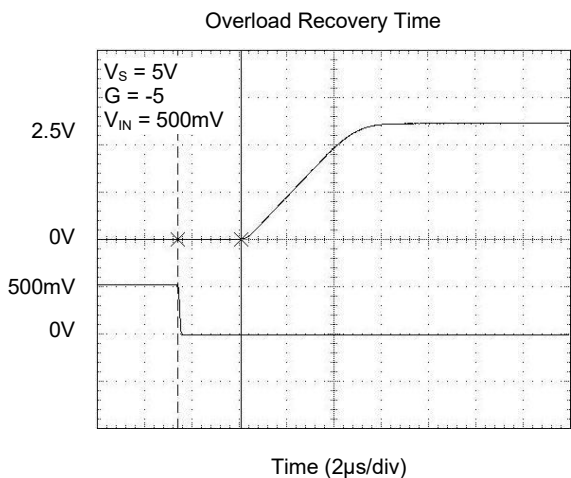
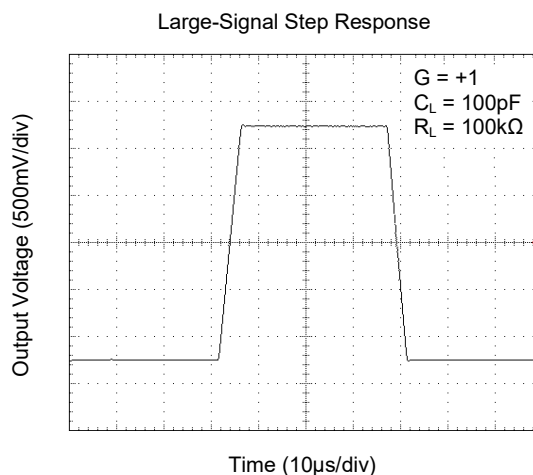
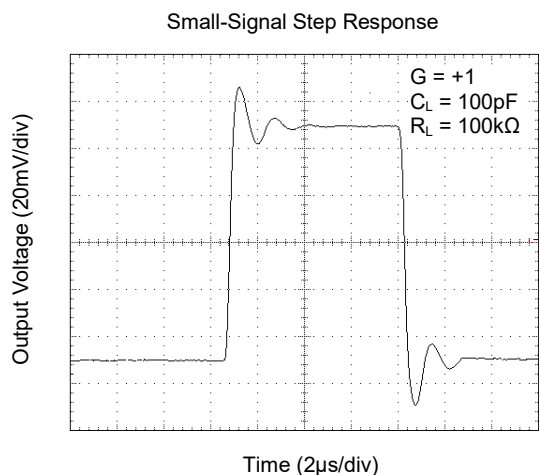
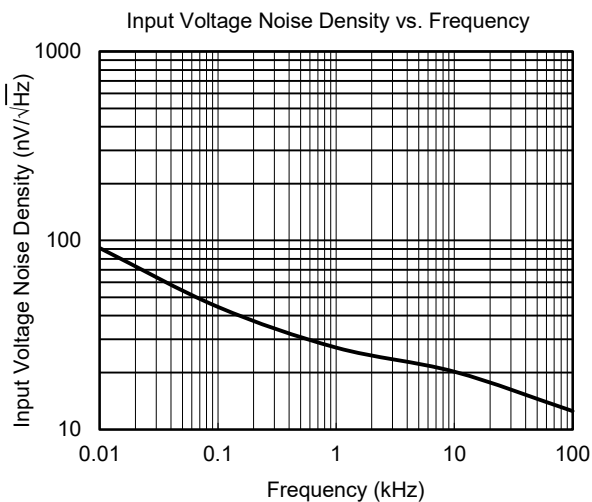
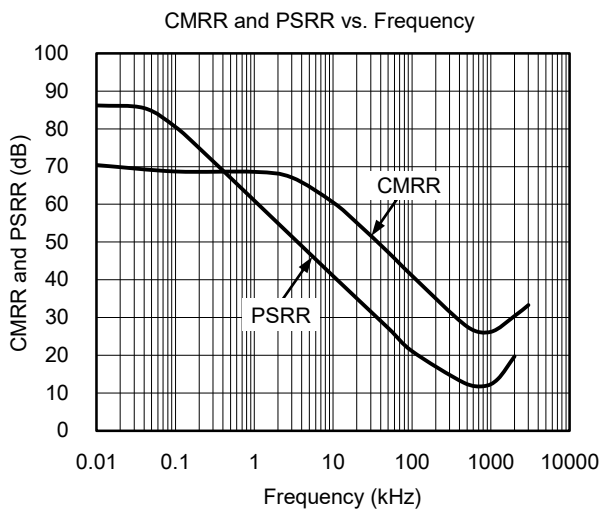

REVISION HISTORY

NOTE: Page numbers for previous revisions may differ from page numbers in the current version.

NOVEMBER 2018 – REV.C.3 to REV.C.4	Page
Added Open-Loop Gain and Phase vs. Frequency	6

JANUARY 2018 – REV.C.2 to REV.C.3	Page
Changed Packing Option	2

JULY 2014 – REV.C.1 to REV.C.2	Page
Added TSSOP-8 package for SGM8542	1, 2, 13, 16

JANUARY 2013 – REV.C to REV.C.1	Page
Added Tape and Reel Information	15, 16

PACKAGE OUTLINE DIMENSIONS

SOT-23-5

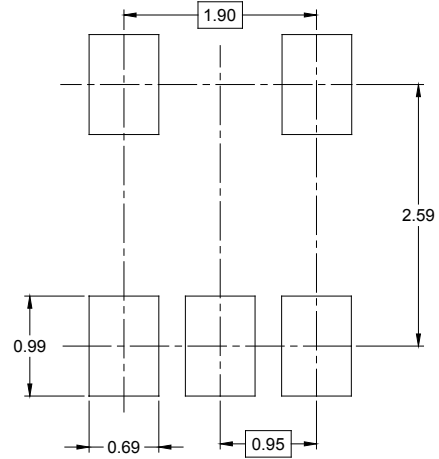

RECOMMENDED LAND PATTERN (Unit: mm)



Symbol	Dimensions In Millimeters		Dimensions In Inches	
	MIN	MAX	MIN	MAX
A	1.050	1.250	0.041	0.049
A1	0.000	0.100	0.000	0.004
A2	1.050	1.150	0.041	0.045
b	0.300	0.500	0.012	0.020
c	0.100	0.200	0.004	0.008
D	2.820	3.020	0.111	0.119
E	1.500	1.700	0.059	0.067
E1	2.650	2.950	0.104	0.116
e	0.950 BSC		0.037 BSC	
e1	1.900 BSC		0.075 BSC	
L	0.300	0.600	0.012	0.024
θ	0°	8°	0°	8°

PACKAGE OUTLINE DIMENSIONS

SC70-5

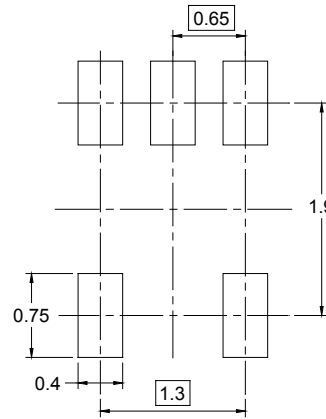
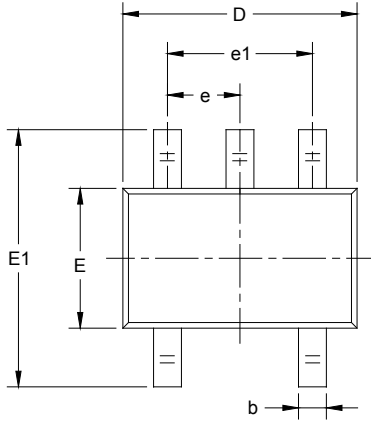

RECOMMENDED LAND PATTERN (Unit: mm)

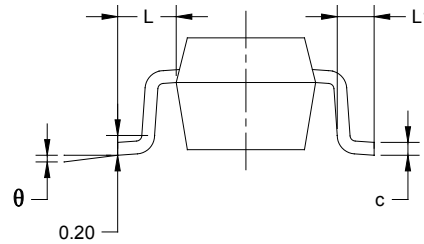
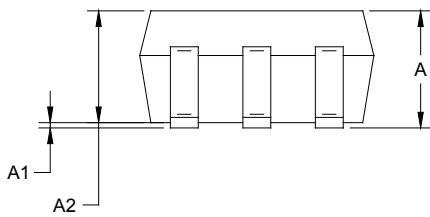

Symbol	Dimensions In Millimeters		Dimensions In Inches	
	MIN	MAX	MIN	MAX
A	0.900	1.100	0.035	0.043
A1	0.000	0.100	0.000	0.004
A2	0.900	1.000	0.035	0.039
b	0.150	0.350	0.006	0.014
c	0.080	0.150	0.003	0.006
D	2.000	2.200	0.079	0.087
E	1.150	1.350	0.045	0.053
E1	2.150	2.450	0.085	0.096
e	0.65 TYP		0.026 TYP	
e1	1.300 BSC		0.051 BSC	
L	0.525 REF		0.021 REF	
L1	0.260	0.460	0.010	0.018
theta	0°	8°	0°	8°

PACKAGE OUTLINE DIMENSIONS

SOIC-8

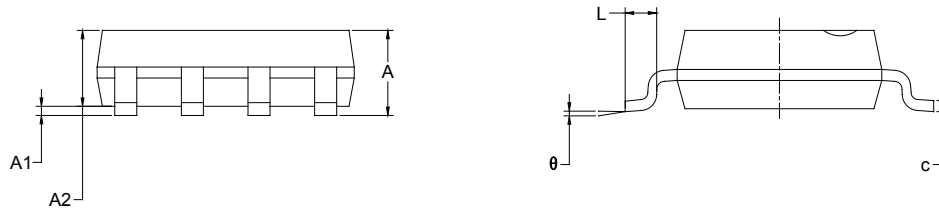
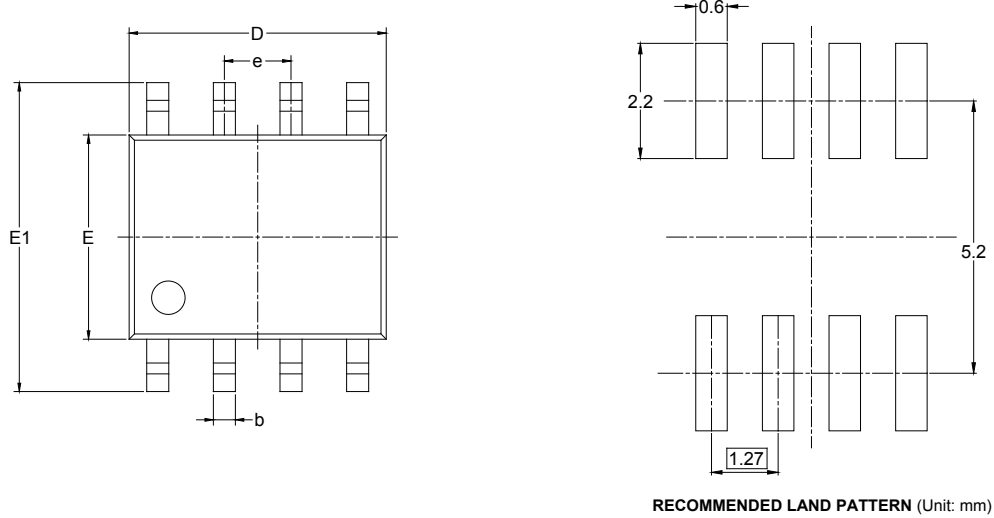

Symbol	Dimensions In Millimeters		Dimensions In Inches	
	MIN	MAX	MIN	MAX
A	1.350	1.750	0.053	0.069
A1	0.100	0.250	0.004	0.010
A2	1.350	1.550	0.053	0.061
b	0.330	0.510	0.013	0.020
c	0.170	0.250	0.006	0.010
D	4.700	5.100	0.185	0.200
E	3.800	4.000	0.150	0.157
E1	5.800	6.200	0.228	0.244
e	1.27 BSC		0.050 BSC	
L	0.400	1.270	0.016	0.050
θ	0°	8°	0°	8°

PACKAGE OUTLINE DIMENSIONS

MSOP-8

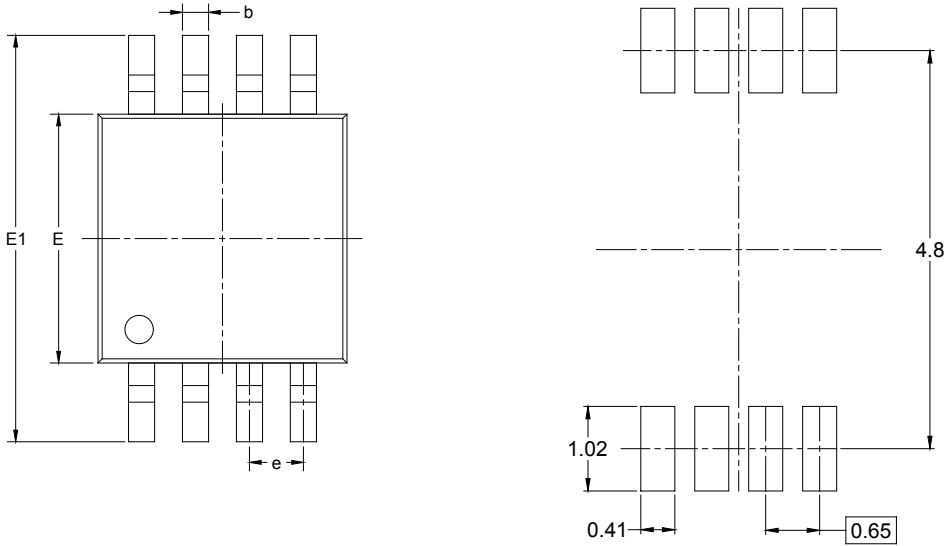

RECOMMENDED LAND PATTERN (Unit: mm)

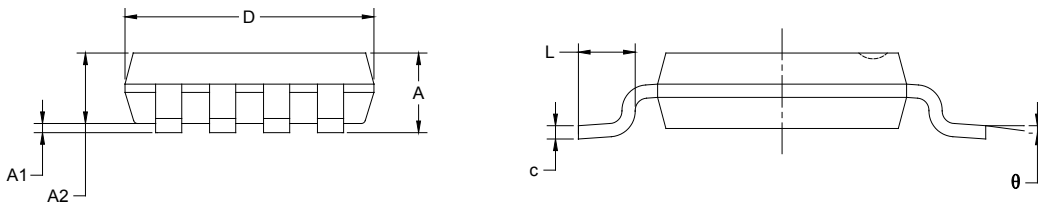

Symbol	Dimensions In Millimeters		Dimensions In Inches	
	MIN	MAX	MIN	MAX
A	0.820	1.100	0.032	0.043
A1	0.020	0.150	0.001	0.006
A2	0.750	0.950	0.030	0.037
b	0.250	0.380	0.010	0.015
c	0.090	0.230	0.004	0.009
D	2.900	3.100	0.114	0.122
E	2.900	3.100	0.114	0.122
E1	4.750	5.050	0.187	0.199
e	0.650 BSC		0.026 BSC	
L	0.400	0.800	0.016	0.031
θ	0°	6°	0°	6°

PACKAGE OUTLINE DIMENSIONS

TSSOP-8

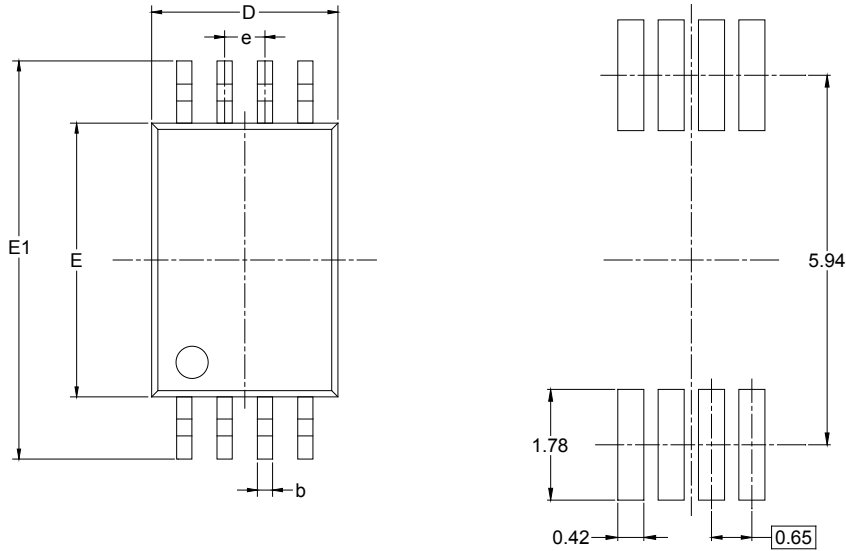

RECOMMENDED LAND PATTERN (Unit: mm)

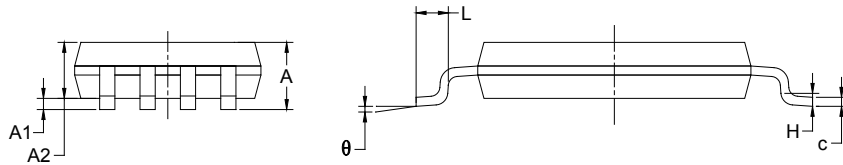

Symbol	Dimensions In Millimeters		Dimensions In Inches	
	MIN	MAX	MIN	MAX
A		1.100		0.043
A1	0.050	0.150	0.002	0.006
A2	0.800	1.000	0.031	0.039
b	0.190	0.300	0.007	0.012
c	0.090	0.200	0.004	0.008
D	2.900	3.100	0.114	0.122
E	4.300	4.500	0.169	0.177
E1	6.250	6.550	0.246	0.258
e	0.650 BSC		0.026 BSC	
L	0.500	0.700	0.02	0.028
H	0.25 TYP		0.01 TYP	
θ	1°	7°	1°	7°

PACKAGE INFORMATION

PACKAGE OUTLINE DIMENSIONS

SOIC-14

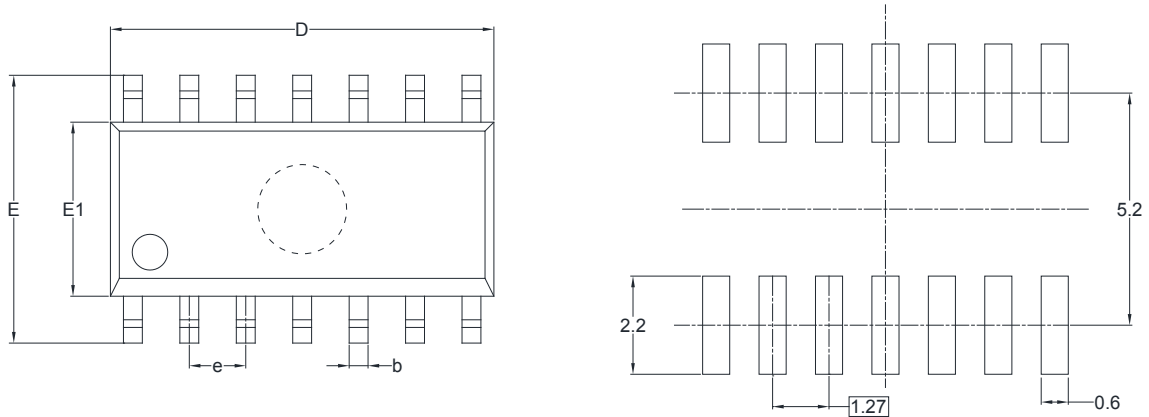

RECOMMENDED LAND PATTERN (Unit: mm)

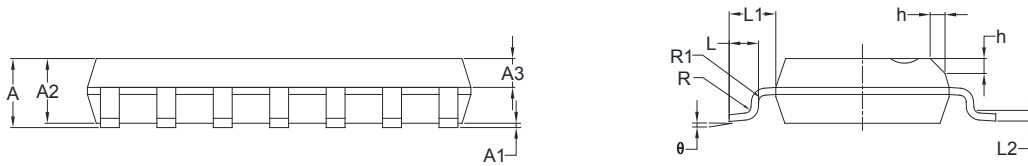

Symbol	Dimensions In Millimeters		Dimensions In Inches	
	MIN	MAX	MIN	MAX
A	1.35	1.75	0.053	0.069
A1	0.10	0.25	0.004	0.010
A2	1.25	1.65	0.049	0.065
A3	0.55	0.75	0.022	0.030
b	0.36	0.49	0.014	0.019
D	8.53	8.73	0.336	0.344
E	5.80	6.20	0.228	0.244
E1	3.80	4.00	0.150	0.157
e	1.27 BSC		0.050 BSC	
L	0.45	0.80	0.018	0.032
L1	1.04 REF		0.040 REF	
L2	0.25 BSC		0.01 BSC	
R	0.07		0.003	
R1	0.07		0.003	
h	0.30	0.50	0.012	0.020
θ	0°	8°	0°	8°

PACKAGE OUTLINE DIMENSIONS

TSSOP-14

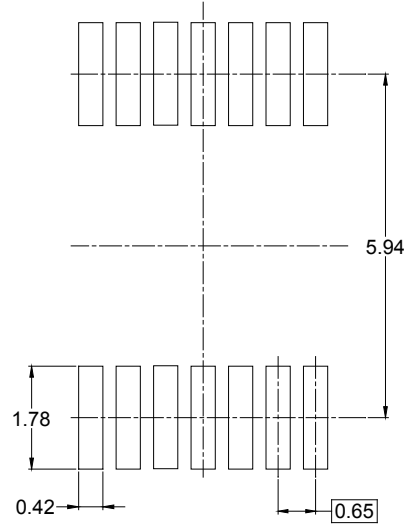
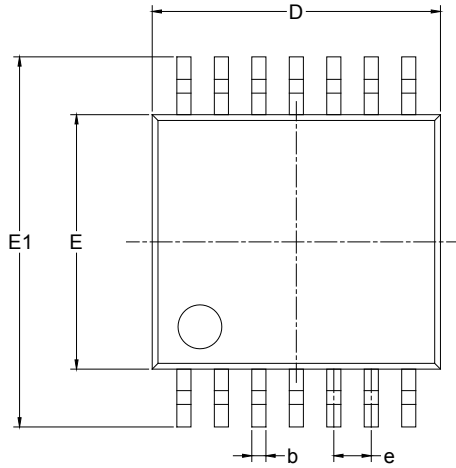

RECOMMENDED LAND PATTERN (Unit: mm)

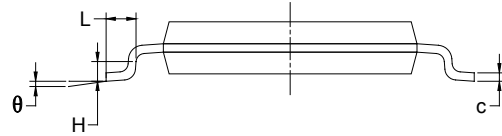
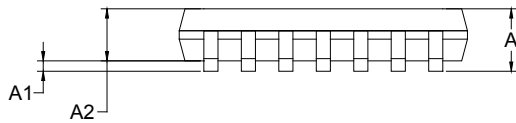

Symbol	Dimensions In Millimeters		Dimensions In Inches	
	MIN	MAX	MIN	MAX
A		1.200		0.047
A1	0.050	0.150	0.002	0.006
A2	0.800	1.050	0.031	0.041
b	0.190	0.300	0.007	0.012
c	0.090	0.200	0.004	0.008
D	4.860	5.100	0.191	0.201
E	4.300	4.500	0.169	0.177
E1	6.250	6.550	0.246	0.258
e	0.650 BSC		0.026 BSC	
L	0.500	0.700	0.02	0.028
H	0.25 TYP		0.01 TYP	
θ	1°	7°	1°	7°

TAPE AND REEL INFORMATION

REEL DIMENSIONS

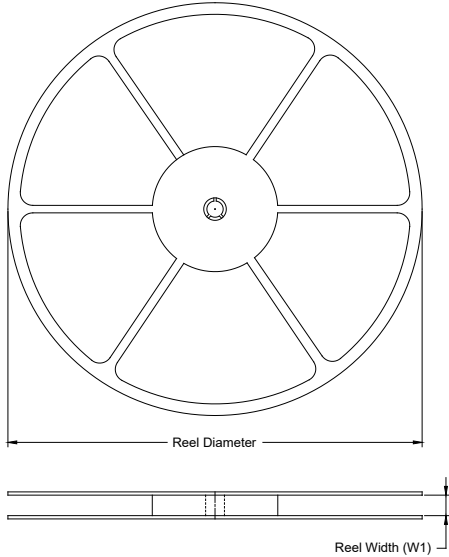

TAPE DIMENSIONS



NOTE: The picture is only for reference. Please make the object as the standard.

KEY PARAMETER LIST OF TAPE AND REEL

Package Type	Reel Diameter	Reel Width W1 (mm)	A0 (mm)	B0 (mm)	K0 (mm)	P0 (mm)	P1 (mm)	P2 (mm)	W (mm)	Pin1 Quadrant
SOT-23-5	7"	9.5	3.20	3.20	1.40	4.0	4.0	2.0	8.0	Q3
SC70-5	7"	9.5	2.25	2.55	1.20	4.0	4.0	2.0	8.0	Q3
SOIC-8	13"	12.4	6.40	5.40	2.10	4.0	8.0	2.0	12.0	Q1
MSOP-8	13"	12.4	5.20	3.30	1.50	4.0	8.0	2.0	12.0	Q1
TSSOP-8	13"	12.4	6.76	3.30	1.80	4.0	8.0	2.0	12.0	Q1
SOIC-14	13"	16.4	6.60	9.30	2.10	4.0	8.0	2.0	16.0	Q1
TSSOP-14	13"	12.4	6.95	5.60	1.20	4.0	8.0	2.0	12.0	Q1

000001

PACKAGE INFORMATION

CARTON BOX DIMENSIONS



NOTE: The picture is only for reference. Please make the object as the standard.

KEY PARAMETER LIST OF CARTON BOX

Reel Type	Length (mm)	Width (mm)	Height (mm)	Pizza/Carton
7" (Option)	368	227	224	8
7"	442	410	224	18
13"	386	280	370	5

DD0002

单击下面可查看定价，库存，交付和生命周期等信息

[>>SGMICRO\(圣邦微电子\)](#)