

GENERAL DESCRIPTION

The SGM800 can monitor system voltages from 1.6V to 5V. When V_{CC} voltage drops below the reset threshold, the device will send a reset signal. When V_{CC} voltage rises to the reset threshold, the reset output remains low within a user-adjustable reset timeout period set by an external capacitor. The SGM800 also features an excellent transient immunity to ignore fast V_{CC} transients.

The SGM800 is available in a Green SOT-23-5 package. It operates over an ambient temperature range of -40°C to $+85^{\circ}\text{C}$.

FEATURES

- **Detection Voltages Range: 1.6V to 5V**
- **Low Quiescent Current: 3 μ A (TYP)**
- **Adjustable Reset Timeout Period: 3ms to 5.75ms**
- **Guaranteed $\overline{\text{RESET}}$ Valid to $V_{CC} = 1\text{V}$**
- **Open-Drain $\overline{\text{RESET}}$ Output**
- **-40°C to $+85^{\circ}\text{C}$ Operating Temperature Range**
- **Available in a Green SOT-23-5 Package**

APPLICATIONS

- Computers
- Battery-Powered Applications
- Portable Equipment
- Controllers
- Intelligent Instruments
- Critical μ P Power Monitoring

TYPICAL APPLICATION

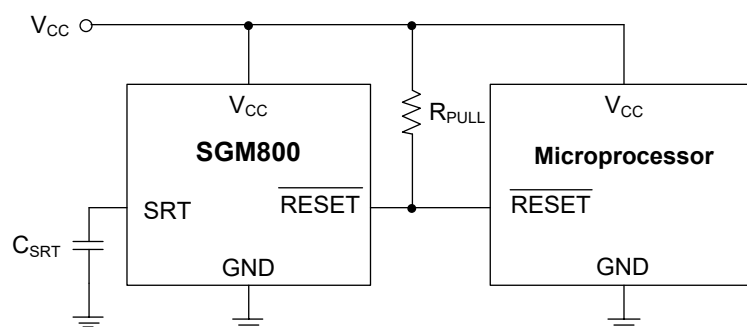

PACKAGE/ORDERING INFORMATION

MODEL	PACKAGE DESCRIPTION	RESET THRESHOLD (V)	ORDERING NUMBER	PACKAGE MARKING	PACKING OPTION
SGM800	SOT-23-5	1.63	SGM800-1.63YN5G/TR	S69XX	Tape and Reel, 3000
		2.32	SGM800-2.32YN5G/TR	S6AXX	Tape and Reel, 3000
		2.63	SGM800-2.63YN5G/TR	S6BXX	Tape and Reel, 3000
		2.93	SGM800-2.93YN5G/TR	S6CXX	Tape and Reel, 3000

MARKING INFORMATION

NOTE: XX = Date Code.

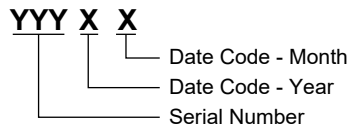

Green (RoHS & HSF): SG Micro Corp defines "Green" to mean Pb-Free (RoHS compatible) and free of halogen substances. If you have additional comments or questions, please contact your SGMICRO representative directly.

ABSOLUTE MAXIMUM RATINGS

All Voltages Referenced to GND

V_{CC}	-0.3V to 6V
\overline{RESET} (Open-Drain).....	-0.3V to 6V
Input Current (All Pins)	20mA
Output Current (\overline{RESET}).....	20mA
Junction Temperature.....	+150°C
Storage Temperature Range	-65°C to +150°C
Lead Temperature (Soldering, 10s).....	+260°C
ESD Susceptibility	
HBM.....	3000V
MM.....	300V

RECOMMENDED OPERATING CONDITIONS

Operating Temperature Range	-40°C to +85°C
-----------------------------------	----------------

OVERSTRESS CAUTION

Stresses beyond those listed in Absolute Maximum Ratings may cause permanent damage to the device. Exposure to absolute maximum rating conditions for extended periods may affect reliability. Functional operation of the device at any conditions beyond those indicated in the Recommended Operating Conditions section is not implied.

ESD SENSITIVITY CAUTION

This integrated circuit can be damaged if ESD protections are not considered carefully. SGMICRO recommends that all integrated circuits be handled with appropriate precautions. Failure to observe proper handling and installation procedures can cause damage. ESD damage can range from subtle performance degradation to complete device failure. Precision integrated circuits may be more susceptible to damage because even small parametric changes could cause the device not to meet the published specifications.

DISCLAIMER

SG Micro Corp reserves the right to make any change in circuit design, or specifications without prior notice.

PIN CONFIGURATION

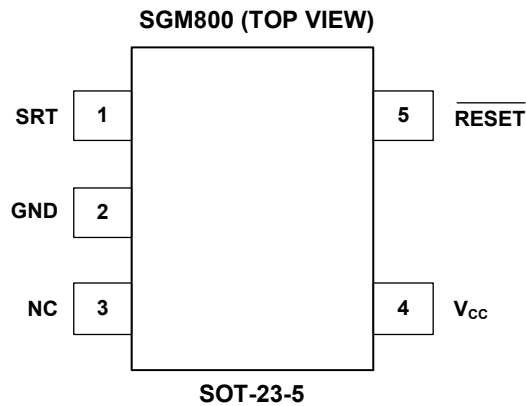

PIN DESCRIPTION

PIN	NAME	FUNCTION
1	SRT	Set Reset Timeout Input Pin. Set a capacitor between SRT and GND to adjust the timeout period (t_{RP}). It is determined by: $t_{RP} (\mu s) = 2.6 \times 10^6 \times C_{SRT} (\mu F) + 340 \mu s$
2	GND	Ground Pin.
3	NC	Not Connected.
4	V _{CC}	Supply Voltage Pin.
5	$\overline{\text{RESET}}$	Active-Low Reset Output. If V _{CC} is lower than the reset threshold, the $\overline{\text{RESET}}$ goes low. If V _{CC} voltage is higher than the reset threshold, the reset output remains low within t_{RP} .

ELECTRICAL CHARACTERISTICS(V_{CC} = 1V to 5.5V, T_A = -40°C to +85°C, typical values are at V_{CC} = 5V and T_A = +25°C, unless otherwise specified.)

PARAMETER	SYMBOL	CONDITIONS	MIN	TYP	MAX	UNITS
Supply Voltage Range	V _{CC}		1.0		5.5	V
Supply Current	I _{CC}	V _{CC} ≤ 5.0V		3.9	7.0	μA
		V _{CC} ≤ 3.3V		3.4	5.5	
		V _{CC} ≤ 2.0V		3.0	4.8	
V _{CC} Reset Threshold Accuracy	V _{TH}	T _A = +25°C	V _{TH} - 2.5%		V _{TH} + 2.5%	V
		T _A = -40°C to +85°C	V _{TH} - 3.5%		V _{TH} + 3.5%	
Hysteresis	V _{HYST}			4 × V _{TH}		mV
V _{CC} to Reset Delay	t _{RD}	V _{CC} falling at 1mV/μs		80		μs
Reset Timeout Period	t _{RP}	C _{SRT} = 1500pF	3.00	4.25	5.75	ms
		C _{SRT} = 0		0.34		
V _{SRT} Ramp Current	I _{RAMP}	V _{SRT} = 0 to 0.65V, V _{CC} = 1.6V to 5V		210		nA
V _{SRT} Ramp Threshold	V _{TH-RAMP}	V _{CC} = 1.6V to 5V (V _{RAMP} rising)		0.6		V
RESET [−] Output Voltage Low	V _{OL}	V _{CC} ≥ 1.0V, I _{SINK} = 50μA			0.3	V
		V _{CC} ≥ 2.7V, I _{SINK} = 1.2mA			0.3	
		V _{CC} ≥ 4.5V, I _{SINK} = 3.2mA			0.4	
RESET [−] Output Leakage Current, Open-Drain	I _{LKG}	V _{CC} > V _{TH} , reset not asserted			1	μA

TYPICAL PERFORMANCE CHARACTERISTICS

$V_{CC} = 5V$, $C_{SRT} = 1500pF$, $T_A = +25^\circ C$, unless otherwise noted.

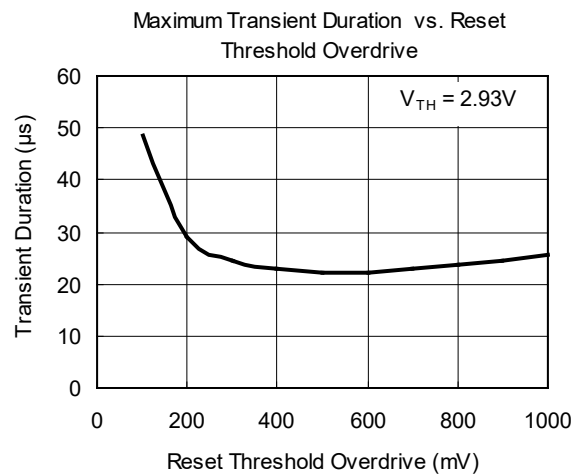
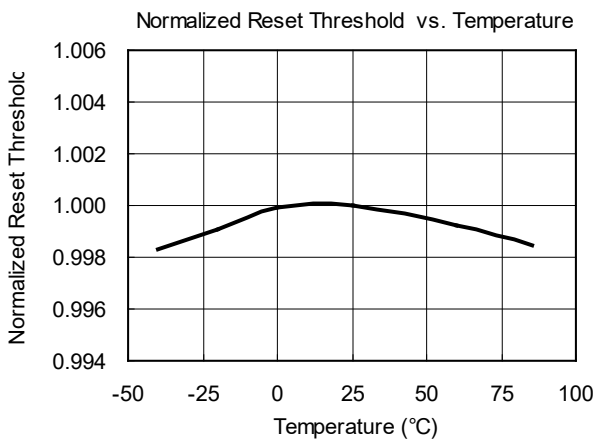
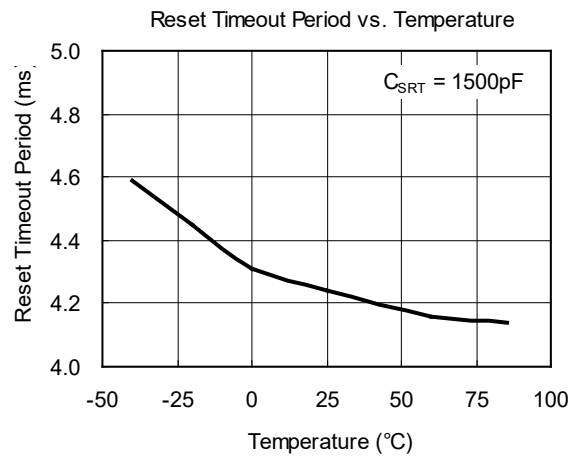
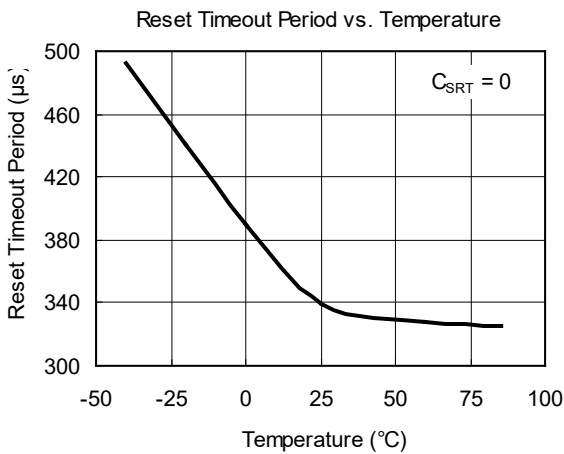
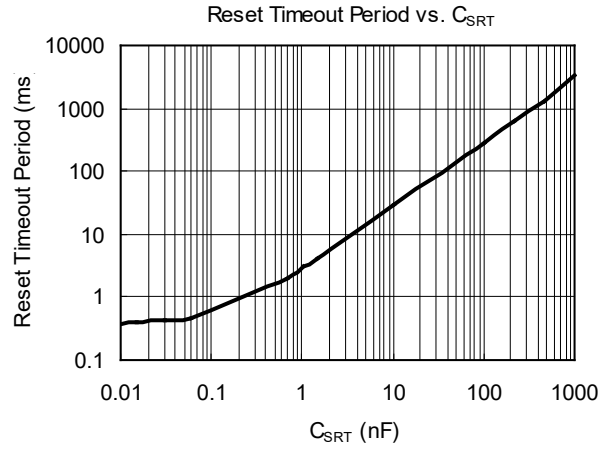
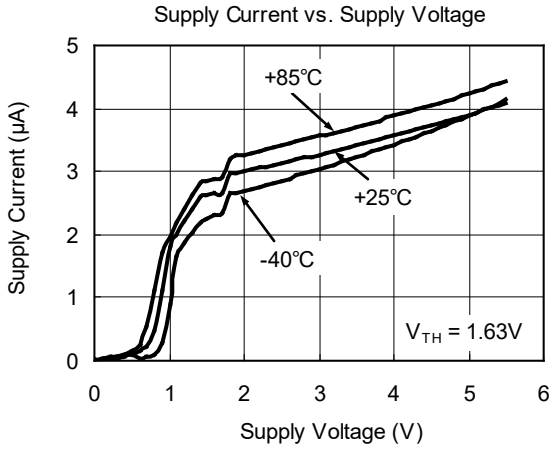

TYPICAL PERFORMANCE CHARACTERISTICS (continued)

$V_{CC} = 5V$, $C_{SRT} = 1500pF$, $T_A = +25^\circ C$, unless otherwise noted.

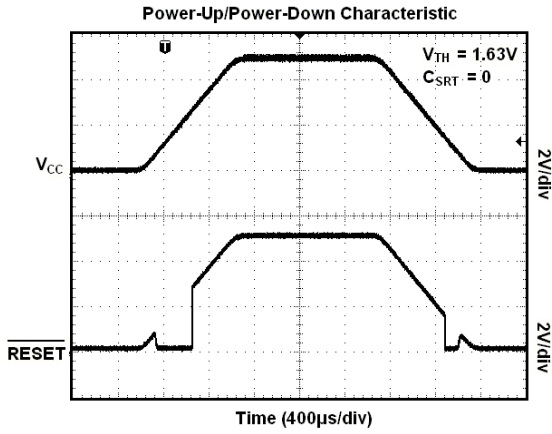

REVISION HISTORY

NOTE: Page numbers for previous revisions may differ from page numbers in the current version.

JANUARY 2013 – REV.A to REV.A.1

Added Tape and Reel Information section 10, 11

Changes from Original (MARCH 2012) to REV.A

Changed from product preview to production data..... All

PACKAGE OUTLINE DIMENSIONS

SOT-23-5

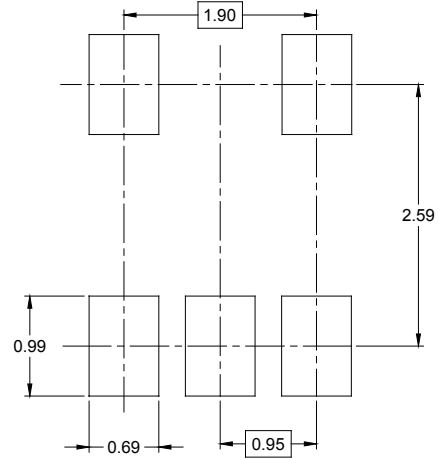
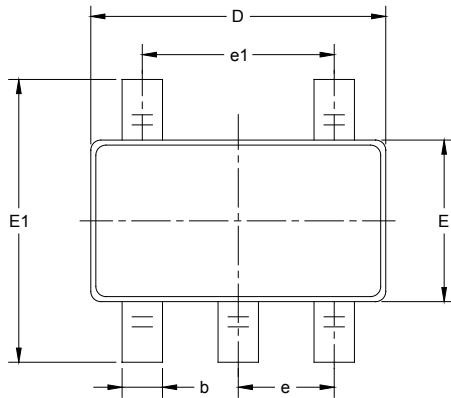

RECOMMENDED LAND PATTERN (Unit: mm)

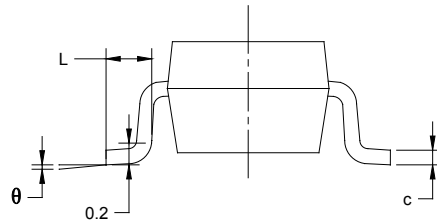
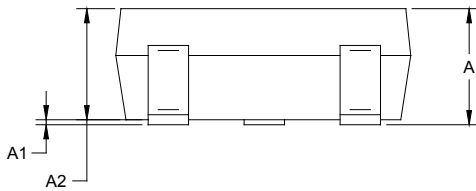

Symbol	Dimensions In Millimeters		Dimensions In Inches	
	MIN	MAX	MIN	MAX
A	1.050	1.250	0.041	0.049
A1	0.000	0.100	0.000	0.004
A2	1.050	1.150	0.041	0.045
b	0.300	0.500	0.012	0.020
c	0.100	0.200	0.004	0.008
D	2.820	3.020	0.111	0.119
E	1.500	1.700	0.059	0.067
E1	2.650	2.950	0.104	0.116
e	0.950 BSC		0.037 BSC	
e1	1.900 BSC		0.075 BSC	
L	0.300	0.600	0.012	0.024
θ	0°	8°	0°	8°

PACKAGE INFORMATION

TAPE AND REEL INFORMATION

REEL DIMENSIONS



TAPE DIMENSIONS



NOTE: The picture is only for reference. Please make the object as the standard.

KEY PARAMETER LIST OF TAPE AND REEL

Package Type	Reel Diameter	Reel Width W1 (mm)	A0 (mm)	B0 (mm)	K0 (mm)	P0 (mm)	P1 (mm)	P2 (mm)	W (mm)	Pin1 Quadrant
SOT-23-5	7"	9.5	3.20	3.20	1.40	4.0	4.0	2.0	8.0	Q3

000001

PACKAGE INFORMATION

CARTON BOX DIMENSIONS



NOTE: The picture is only for reference. Please make the object as the standard.

KEY PARAMETER LIST OF CARTON BOX

Reel Type	Length (mm)	Width (mm)	Height (mm)	Pizza/Carton
7" (Option)	368	227	224	8
7"	442	410	224	18

DD0002

单击下面可查看定价，库存，交付和生命周期等信息

[>>SGMICRO\(圣邦微电子\)](#)