



SGM8749

150ns, Low-Power, 3V/5V, Rail-to-Rail Input, Single-Supply Comparator

GENERAL DESCRIPTION

The SGM8749 is a single, rail-to-rail input, single-supply comparator with typical 22 μ A power supply current. The comparator operates from a wide range of 2.7V to 5.5V supply voltage and features high-speed response, and rail-to-rail input range.

The SGM8749 is optimized for low-power, single-supply operation with greater than rail-to-rail input operation and open-drain output. It interfaces with CMOS/TTL logic. All input and output pins have a continuous short-circuit protection to each rail.

The SGM8749 is available in Green SOT-23-5 and SC70-5 packages. It is rated over the -40°C to +85°C temperature range.

FEATURES

- **Propagation Delay:**
150ns (TYP) at 10mV Overdrive
- **Low Quiescent Current:**
22 μ A (TYP) at $V_{CC} = 3V$
- **Wide Single-Supply Voltage Range: 2.7V to 5.5V**
- **Optimized for 3V/5V Applications**
- **Open-Drain Output Structure**
- **Rail-to-Rail Input**
- **Low Offset Voltage: 0.8mV (TYP)**
- **Output Swing to within 185mV from Rails with 4mA Output Current**
- **CMOS/TTL-Compatible Output**
- **-40°C to +85°C Operating Temperature Range**
- **Available in Green SOT-23-5 and SC70-5 Packages**

APPLICATIONS

Portable and Battery-Powered Applications
3V/5V Systems
Threshold Detectors
Line Receivers

PACKAGE/ORDERING INFORMATION

MODEL	PACKAGE DESCRIPTION	SPECIFIED TEMPERATURE RANGE	ORDERING NUMBER	PACKAGE MARKING	PACKING OPTION
SGM8749	SC70-5	-40°C to +85°C	SGM8749YC5G/TR	SS1XX	Tape and Reel, 3000
	SOT-23-5	-40°C to +85°C	SGM8749YN5G/TR	SS2XX	Tape and Reel, 3000

MARKING INFORMATION

NOTE: XX = Date Code.

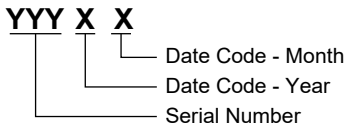

Green (RoHS & HSF): SG Micro Corp defines "Green" to mean Pb-Free (RoHS compatible) and free of halogen substances. If you have additional comments or questions, please contact your SGMICRO representative directly.

ABSOLUTE MAXIMUM RATINGS

Supply Voltage, V_{CC} to GND.....	6V
Differential Input Voltage, V_{IN}	$\pm(V_{CC} - GND)$
Voltage at Input/Output Pins.....	-0.3V to ($V_{CC} + 0.3V$)
Junction Temperature	+150°C
Storage Temperature Range	-65°C to +150°C
Lead Temperature (Soldering, 10s)	+260°C
ESD Susceptibility	
HBM	2000V
MM	400V

Failure to observe proper handling and installation procedures can cause damage. ESD damage can range from subtle performance degradation to complete device failure. Precision integrated circuits may be more susceptible to damage because even small parametric changes could cause the device not to meet the published specifications.

RECOMMENDED OPERATING CONDITIONS

Operating Temperature Range	-40°C to +85°C
Operating Supply Voltage Range.....	2.7V to 5.5V

DISCLAIMER

SG Micro Corp reserves the right to make any change in circuit design, or specifications without prior notice.

OVERSTRESS CAUTION

Stresses beyond those listed in Absolute Maximum Ratings may cause permanent damage to the device. Exposure to absolute maximum rating conditions for extended periods may affect reliability. Functional operation of the device at any conditions beyond those indicated in the Recommended Operating Conditions section is not implied.

PIN CONFIGURATIONS

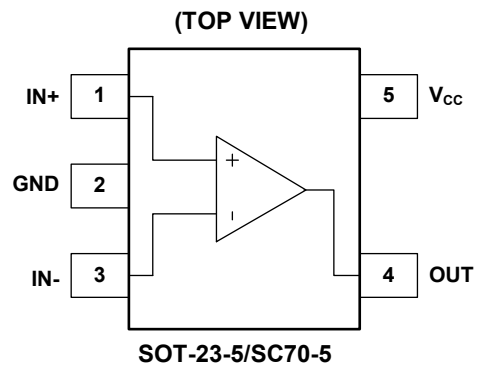

ESD SENSITIVITY CAUTION

This integrated circuit can be damaged if ESD protections are not considered carefully. SGMICRO recommends that all integrated circuits be handled with appropriate precautions.

ELECTRICAL CHARACTERISTICS(V_{CC} = 5V, V_{CM} = 0V, C_L = 15pF, typical values are at T_A = +25°C, unless otherwise noted.)

PARAMETER	SYMBOL	CONDITIONS	MIN	TYP	MAX	UNITS
Operating Supply Voltage Range	V _{CC}		2.7		5.5	V
Input Common Mode Voltage Range	V _{CM}		-0.1		V _{CC} + 0.1	V
Input Offset Voltage	V _{OS}	V _{CC} = 5V, V _{CM} = 0V, Out = 0V		0.8	4.5	mV
		-40°C to +85°C			4.7	
		V _{CC} = 5V, V _{CM} = 5V, Out = 0V		0.9	4.8	
		-40°C to +85°C			4.9	
Output Short-Circuit Current	I _{SINK}	V _{CC} = 5V, Out to V _{CC} /2		-33	-28	mA
		-40°C to +85°C			-22	
Common Mode Rejection Ratio	CMRR	V _{CC} = 5V, V _{CM} = 0V to 5V	60	77		dB
		-40°C to +85°C	58			
Power Supply Rejection Ratio	PSRR	V _{CM} = 0V, V _{CC} = 2.7V to 5.5V	68	79		dB
		-40°C to +85°C	66			
Output Voltage Swing from Rail	V _{OL}	V _{CC} = 5V, I _{OUT} = -4mA		185	218	mV
		-40°C to +85°C			262	
Supply Current	I _S	V _{CC} = 3V, V _{OUT} = L, I _{OUT} = 0mA		22	32	μA
		-40°C to +85°C			38	
		V _{CC} = 5V, V _{OUT} = L, I _{OUT} = 0mA		25	35	
		-40°C to +85°C			44	
Propagation Delay (High to Low)		V _{CC} = 3V, Overdrive = 10mV		150		ns
		V _{CC} = 3V, Overdrive = 100mV		97		
Fall Time	t _{FALL}	Overdrive = 10mV		8		ns
		Overdrive = 100mV		6		

TYPICAL PERFORMANCE CHARACTERISTICS

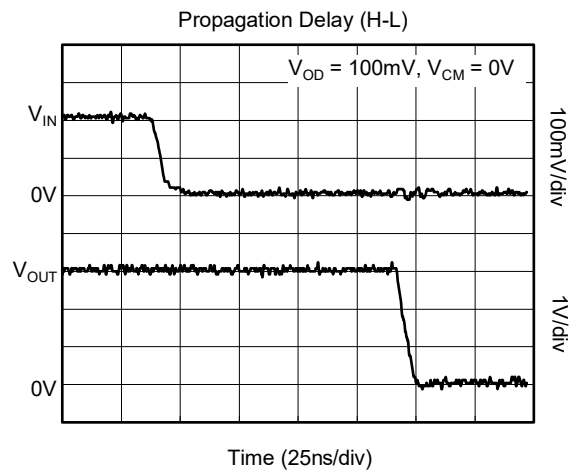
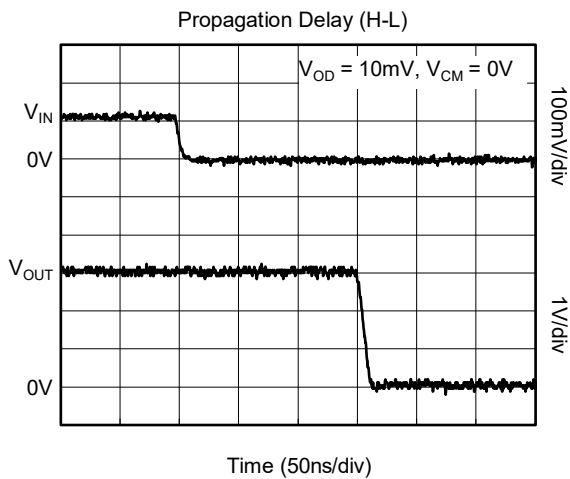
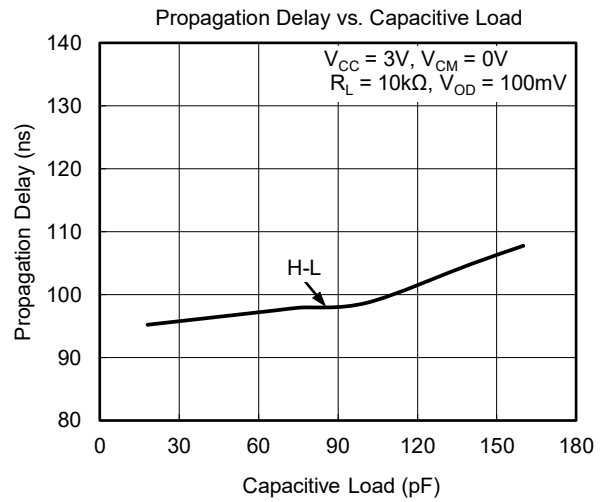
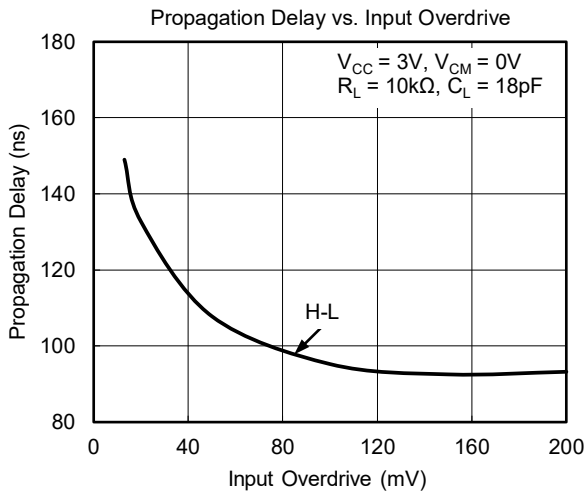
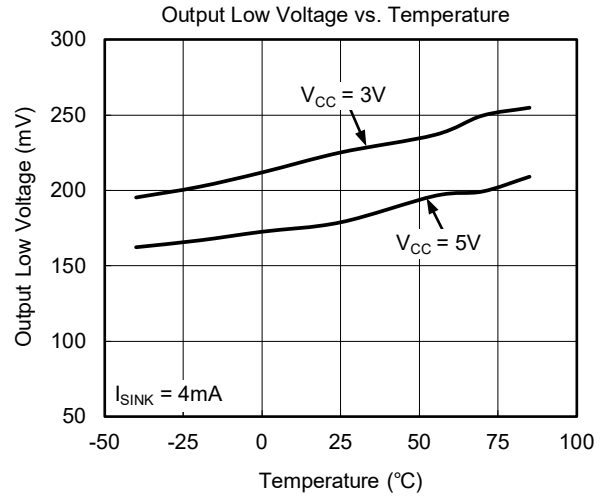
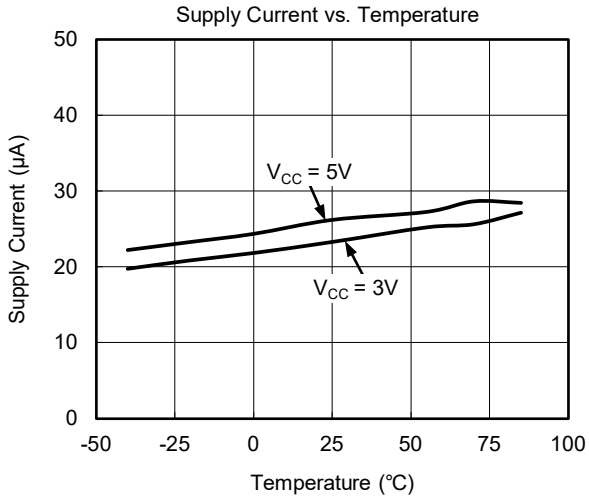

TYPICAL PERFORMANCE CHARACTERISTICS (continued)

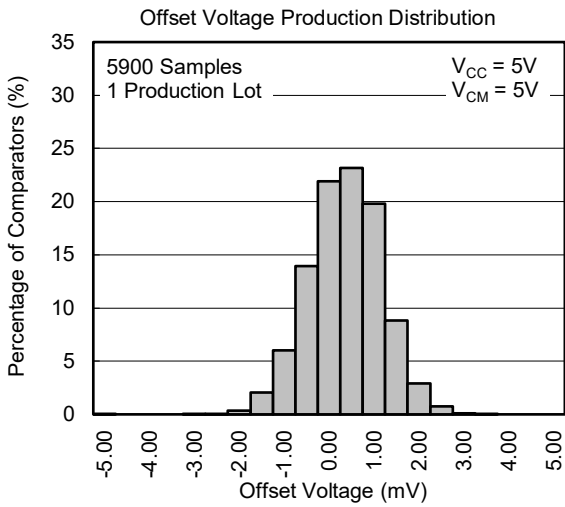
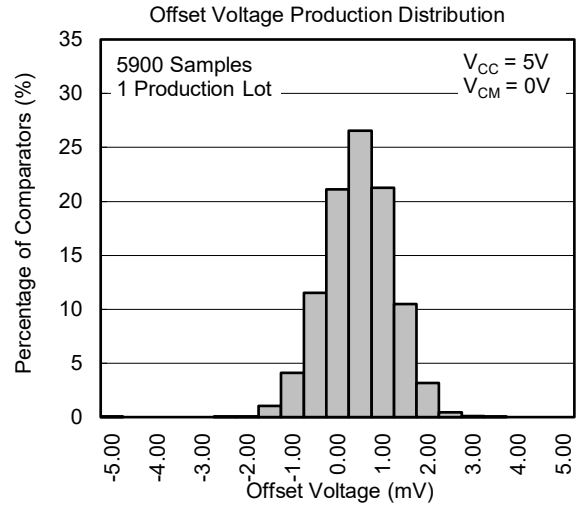
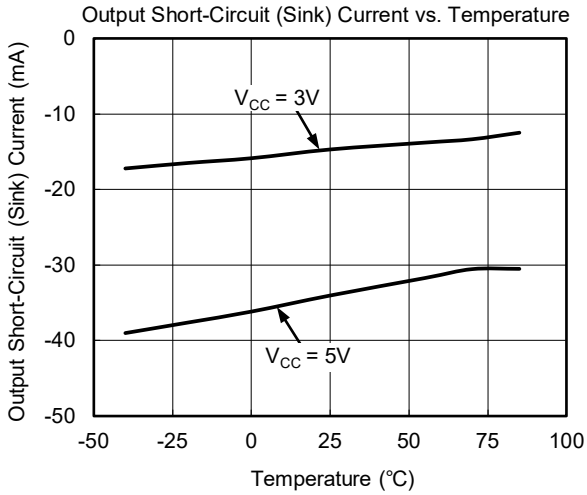

REVISION HISTORY

NOTE: Page numbers for previous revisions may differ from page numbers in the current version.

AUGUST 2021 – REV.A to REV.A.1		Page
Updated General Description section.....		1
Updated Pin Configurations section.....		2
Updated Electrical Characteristics section.....		3
Changes from Original (JUNE 2015) to REV.A		
Changed from product preview to production data.....		All

PACKAGE OUTLINE DIMENSIONS

SC70-5

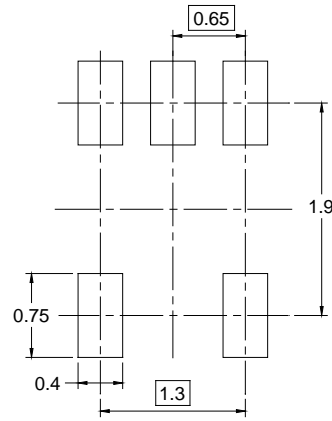
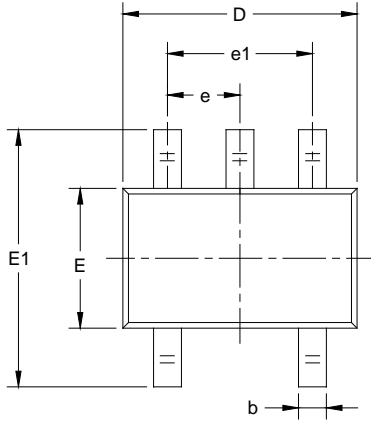

RECOMMENDED LAND PATTERN (Unit: mm)

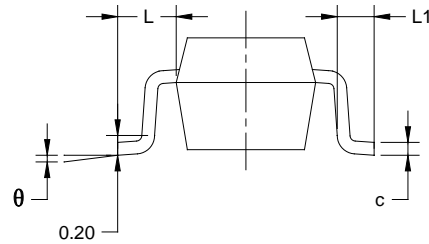
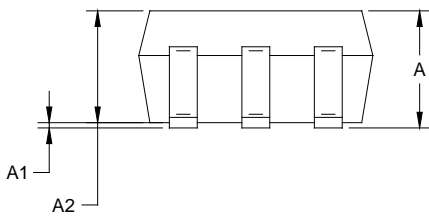

Symbol	Dimensions In Millimeters		Dimensions In Inches	
	MIN	MAX	MIN	MAX
A	0.900	1.100	0.035	0.043
A1	0.000	0.100	0.000	0.004
A2	0.900	1.000	0.035	0.039
b	0.150	0.350	0.006	0.014
c	0.080	0.150	0.003	0.006
D	2.000	2.200	0.079	0.087
E	1.150	1.350	0.045	0.053
E1	2.150	2.450	0.085	0.096
e	0.65 TYP		0.026 TYP	
e1	1.300 BSC		0.051 BSC	
L	0.525 REF		0.021 REF	
L1	0.260	0.460	0.010	0.018
θ	0°	8°	0°	8°

NOTES:

1. Body dimensions do not include mode flash or protrusion.
2. This drawing is subject to change without notice.

PACKAGE OUTLINE DIMENSIONS

SOT-23-5

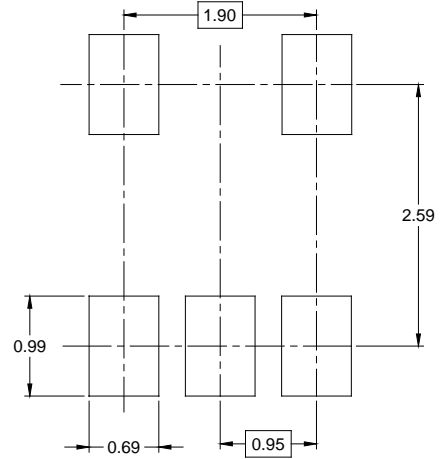
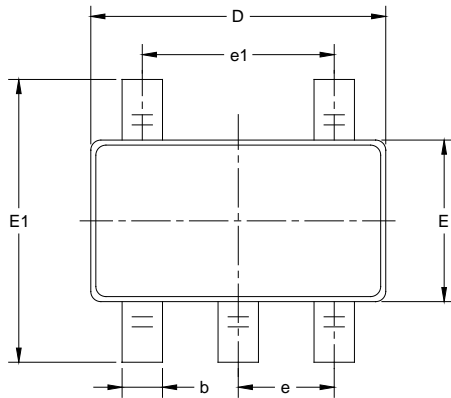

RECOMMENDED LAND PATTERN (Unit: mm)

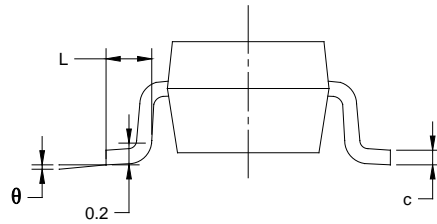
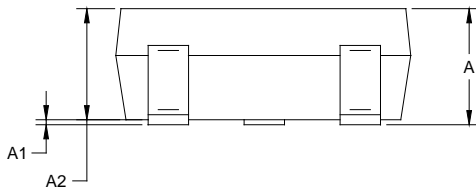

Symbol	Dimensions In Millimeters		Dimensions In Inches	
	MIN	MAX	MIN	MAX
A	1.050	1.250	0.041	0.049
A1	0.000	0.100	0.000	0.004
A2	1.050	1.150	0.041	0.045
b	0.300	0.500	0.012	0.020
c	0.100	0.200	0.004	0.008
D	2.820	3.020	0.111	0.119
E	1.500	1.700	0.059	0.067
E1	2.650	2.950	0.104	0.116
e	0.950 BSC		0.037 BSC	
e1	1.900 BSC		0.075 BSC	
L	0.300	0.600	0.012	0.024
θ	0°	8°	0°	8°

NOTES:

1. Body dimensions do not include mode flash or protrusion.
2. This drawing is subject to change without notice.

TAPE AND REEL INFORMATION

REEL DIMENSIONS



TAPE DIMENSIONS



NOTE: The picture is only for reference. Please make the object as the standard.

KEY PARAMETER LIST OF TAPE AND REEL

Package Type	Reel Diameter	Reel Width W1 (mm)	A0 (mm)	B0 (mm)	K0 (mm)	P0 (mm)	P1 (mm)	P2 (mm)	W (mm)	Pin1 Quadrant
SC70-5	7"	9.5	2.25	2.55	1.20	4.0	4.0	2.0	8.0	Q3
SOT-23-5	7"	9.5	3.20	3.20	1.40	4.0	4.0	2.0	8.0	Q3

DD0001

PACKAGE INFORMATION

CARTON BOX DIMENSIONS



NOTE: The picture is only for reference. Please make the object as the standard.

KEY PARAMETER LIST OF CARTON BOX

Reel Type	Length (mm)	Width (mm)	Height (mm)	Pizza/Carton
7" (Option)	368	227	224	8
7"	442	410	224	18

DD0002

单击下面可查看定价，库存，交付和生命周期等信息

[>>SGMICRO\(圣邦微电子\)](#)