

### GENERAL DESCRIPTION

The SGM8702 is a single, rail-to-rail input CMOS comparator with typical 300nA ultra-low power supply current. The comparator operates from a wide range of 1.4V to 5.5V supply voltage, and is guaranteed to operate at 1.4V, 2.5V and 5.0V. This feature is suitable for battery-powered applications.

The SGM8702 is optimized for micro-power, single-supply operation. The open-drain output stage allows for operation with absolute minimum power consumption when driving any capacitive or resistive load.

The SGM8702 is available in Green SOT-23-5 and SC70-5 space-saving packages. The small packages make this device ideal for use in hand-held electronics and mobile phone applications. It is rated over the -40°C to +85°C temperature range.

### FEATURES

- **Ultra-Low Quiescent Current:**  
300nA (TYP) at  $V_S = 1.4V$
- **Wide Single-Supply Voltage Range: 1.4V to 5.5V**
- **Typical 6µs Propagation Delay at  $V_S = 1.4V$**
- **Rail-to-Rail Input and Output**
- **P-MOSFET Open-Drain Output Structure**
- **Open Drain Output Current Drive:**  
18mA (TYP) at  $V_S = 5V$
- **-40°C to +85°C Operating Temperature Range**
- **Available in Green SOT-23-5 and SC70-5 Packages**

### APPLICATIONS

- Portable and Battery-Powered Applications
- Alarm and Surveillance Circuits
- Mobile Phones
- RC Timers
- Hand-Held Electronics
- Window Detectors
- IR Receiver

### TYPICAL APPLICATION

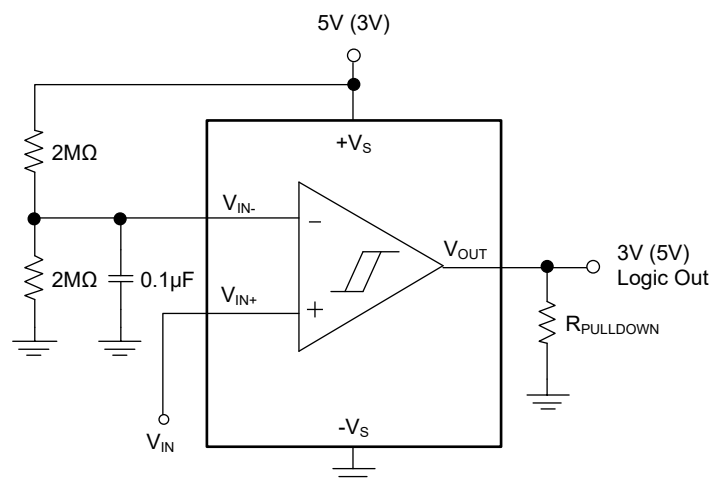

**PACKAGE/ORDERING INFORMATION**

MODEL	PACKAGE DESCRIPTION	SPECIFIED TEMPERATURE RANGE	ORDERING NUMBER	PACKAGE MARKING	PACKING OPTION
SGM8702	SOT-23-5	-40°C to +85°C	SGM8702YN5G/TR	S5BXX	Tape and Reel, 3000
	SC70-5	-40°C to +85°C	SGM8702YC5G/TR	S5CXX	Tape and Reel, 3000

**MARKING INFORMATION**

NOTE: XX = Date Code.

**SOT-23-5/SC70-5**

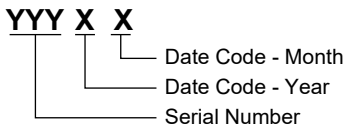

Green (RoHS & HSF): SG Micro Corp defines "Green" to mean Pb-Free (RoHS compatible) and free of halogen substances. If you have additional comments or questions, please contact your SGMICRO representative directly.

**ABSOLUTE MAXIMUM RATINGS**

- Supply Voltage, +V<sub>S</sub> to -V<sub>S</sub> ..... 6V
- V<sub>IN</sub> Differential ..... ±2.5V
- Voltage at Input/Output Pins ..... (-V<sub>S</sub>) - 0.3V to (+V<sub>S</sub>) + 0.3V
- Junction Temperature ..... +150°C
- Storage Temperature Range ..... -65°C to +150°C
- Lead Temperature (Soldering, 10s) ..... +260°C
- ESD Susceptibility
- HBM ..... 2000V
- MM ..... 400V

**RECOMMENDED OPERATING CONDITIONS**

- Operating Temperature Range ..... -40°C to +85°C

**OVERSTRESS CAUTION**

Stresses beyond those listed in Absolute Maximum Ratings may cause permanent damage to the device. Exposure to absolute maximum rating conditions for extended periods may affect reliability. Functional operation of the device at any conditions beyond those indicated in the Recommended Operating Conditions section is not implied.

**ESD SENSITIVITY CAUTION**

This integrated circuit can be damaged by ESD if you don't pay attention to ESD protection. SGMICRO recommends that all integrated circuits be handled with appropriate precautions.

Failure to observe proper handling and installation procedures can cause damage. ESD damage can range from subtle performance degradation to complete device failure. Precision integrated circuits may be more susceptible to damage because very small parametric changes could cause the device not to meet its published specifications.

**DISCLAIMER**

SG Micro Corp reserves the right to make any change in circuit design, or specifications without prior notice.

**PIN CONFIGURATIONS**

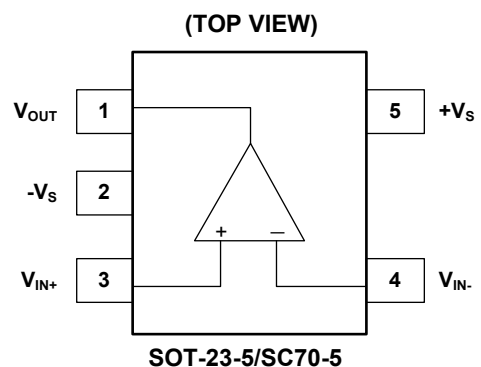

**ELECTRICAL CHARACTERISTICS**(At  $T_A = +25^\circ\text{C}$ ,  $+V_S = 1.4\text{V}$ ,  $-V_S = 0\text{V}$ ,  $V_{CM} = +V_S/2$ ,  $V_{OUT} = +V_S$  and  $R_L = 1\text{k}\Omega$ , unless otherwise noted.)

PARAMETER	SYMBOL	CONDITIONS	MIN	TYP	MAX	UNITS
Supply Current	$I_S$	$V_{CM} = 0.3\text{V}$		300	1000	nA
		$V_{CM} = 1.1\text{V}$		250	1000	
Input Offset Voltage	$V_{OS}$	$V_{CM} = 0\text{V}$	-3	0.5	3	mV
		$V_{CM} = 1.4\text{V}$	-3	0.5	3	
Input Offset Average Drift				2		$\mu\text{V}/^\circ\text{C}$
Common Mode Rejection Ratio	CMRR	$V_{CM}$ Stepped from 0V to 0.3V		65		dB
		$V_{CM}$ Stepped from 0.8V to 1.4V		75		
		$V_{CM}$ Stepped from 0V to 1.4V		75		
Power Supply Rejection Ratio	PSRR	$V_S = 1.8\text{V}$ to $5.5\text{V}$ , $V_{CM} = 0\text{V}$	66	95		dB
Large Signal Voltage Gain	$A_{VO}$			100		dB
Output Swing High	$V_{OH}$	$V_S = 1.8\text{V}$ , $I_{OUT} = 500\mu\text{A}$	1.606	1.666		V
		$-40^\circ\text{C} \leq T_A \leq +85^\circ\text{C}$	1.589			
		$V_S = 1.8\text{V}$ , $I_{OUT} = 1\text{mA}$	1.348	1.498		
		$-40^\circ\text{C} \leq T_A \leq +85^\circ\text{C}$	1.312			
Output Current	$I_{OUT}$	Source		0.7		mA
Leakage Current	$I_{Leakage}$	$V_{OUT} = 0\text{V}$		1		nA
Propagation Delay (High to Low)		Overdrive = 10mV		12		$\mu\text{s}$
		Overdrive = 100mV		6		
Propagation Delay (Low to High)		Overdrive = 10mV		26		$\mu\text{s}$
		Overdrive = 100mV		17		
Rise Time	$t_{Rise}$	Overdrive = 10mV, $C_L = 30\text{pF}$ , $R_L = 1\text{M}\Omega$		220		ns
		Overdrive = 100mV, $C_L = 30\text{pF}$ , $R_L = 1\text{M}\Omega$		220		

**ELECTRICAL CHARACTERISTICS (continued)**(At  $T_A = +25^\circ\text{C}$ ,  $+V_S = 2.5\text{V}$ ,  $-V_S = 0\text{V}$ ,  $V_{CM} = +V_S/2$ ,  $V_{OUT} = +V_S$  and  $R_L = 1\text{k}\Omega$ , unless otherwise noted.)

PARAMETER	SYMBOL	CONDITIONS	MIN	TYP	MAX	UNITS
Supply Current	$I_S$	$V_{CM} = 0.3\text{V}$		310		nA
		$V_{CM} = 2.2\text{V}$		260		
Input Offset Voltage	$V_{OS}$	$V_{CM} = 0\text{V}$		0.5		mV
		$V_{CM} = 2.5\text{V}$		0.5		
Input Offset Average Drift				2		$\mu\text{V}/^\circ\text{C}$
Common Mode Rejection Ratio	CMRR	$V_{CM}$ Stepped from 0V to 1.4V		75		dB
		$V_{CM}$ Stepped from 1.9V to 2.5V		80		
		$V_{CM}$ Stepped from 0V to 2.5V		80		
Power Supply Rejection Ratio	PSRR	$V_S = 1.8\text{V}$ to $5.5\text{V}$ , $V_{CM} = 0\text{V}$		95		dB
Large Signal Voltage Gain	$A_{VO}$			100		dB
Output Swing High	$V_{OH}$	$I_{OUT} = 500\mu\text{A}$		2.417		V
		$I_{OUT} = 1\text{mA}$		2.329		
Output Current	$I_{OUT}$	Source		5.3		mA
Leakage Current	$I_{Leakage}$	$V_{OUT} = 0\text{V}$		2		nA
Propagation Delay (High to Low)		Overdrive = 10mV		12		$\mu\text{s}$
		Overdrive = 100mV		5		
Propagation Delay (Low to High)		Overdrive = 10mV		28		$\mu\text{s}$
		Overdrive = 100mV		19		
Rise Time	$t_{Rise}$	Overdrive = 10mV, $C_L = 30\text{pF}$ , $R_L = 1\text{M}\Omega$		120		ns
		Overdrive = 100mV, $C_L = 30\text{pF}$ , $R_L = 1\text{M}\Omega$		120		

**ELECTRICAL CHARACTERISTICS (continued)**(At  $T_A = +25^\circ\text{C}$ ,  $+V_S = 5.0\text{V}$ ,  $-V_S = 0\text{V}$ ,  $V_{CM} = +V_S/2$ ,  $V_{OUT} = +V_S$  and  $R_L = 1\text{k}\Omega$ , unless otherwise noted.)

PARAMETER	SYMBOL	CONDITIONS	MIN	TYP	MAX	UNITS
Supply Current	$I_S$	$V_{CM} = 0.3\text{V}$		350	2000	nA
		$V_{CM} = 4.7\text{V}$		300	2000	
Input Offset Voltage	$V_{OS}$	$V_{CM} = 0\text{V}$	-3	0.5	3	mV
		$V_{CM} = 5\text{V}$	-3	0.5	3	
Input Offset Average Drift				2		$\mu\text{V}/^\circ\text{C}$
Common Mode Rejection Ratio	CMRR	$V_{CM}$ Stepped from 0V to 3.9V		85		dB
		$V_{CM}$ Stepped from 4.4V to 5.0V		85		
		$V_{CM}$ Stepped from 0V to 5.0V		85		
Power Supply Rejection Ratio	PSRR	$V_S = 1.8\text{V}$ to $5.5\text{V}$ , $V_{CM} = 0\text{V}$	66	95		dB
Large Signal Voltage Gain	$A_{VO}$			105		dB
Output Swing High	$V_{OH}$	$I_{OUT} = 500\mu\text{A}$	4.889	4.951		V
		$-40^\circ\text{C} \leq T_A \leq +85^\circ\text{C}$	4.883			
		$I_{OUT} = 1\text{mA}$	4.861	4.902		
		$-40^\circ\text{C} \leq T_A \leq +85^\circ\text{C}$	4.845			
Output Current	$I_{OUT}$	Source	14	18		mA
		$-40^\circ\text{C} \leq T_A \leq +85^\circ\text{C}$	12.1			
Leakage Current	$I_{Leakage}$	$V_{OUT} = 0\text{V}$		5		nA
Propagation Delay (High to Low)		Overdrive = 10mV		13		$\mu\text{s}$
		Overdrive = 100mV		6		
Propagation Delay (Low to High)		Overdrive = 10mV		42		$\mu\text{s}$
		Overdrive = 100mV		33		
Rise Time	$t_{Rise}$	Overdrive = 10mV, $C_L = 30\text{pF}$ , $R_L = 1\text{M}\Omega$		85		ns
		Overdrive = 100mV, $C_L = 30\text{pF}$ , $R_L = 1\text{M}\Omega$		85		

TYPICAL PERFORMANCE CHARACTERISTICS

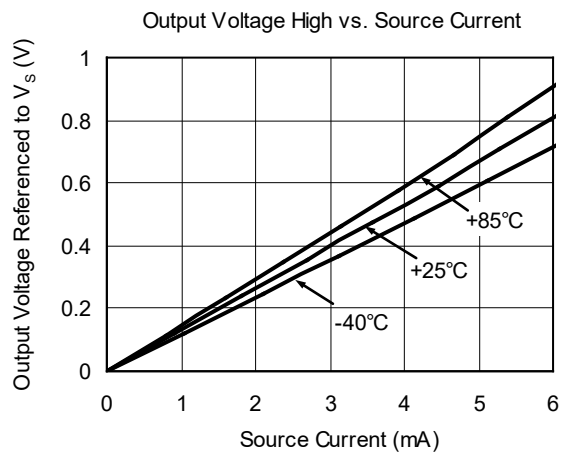
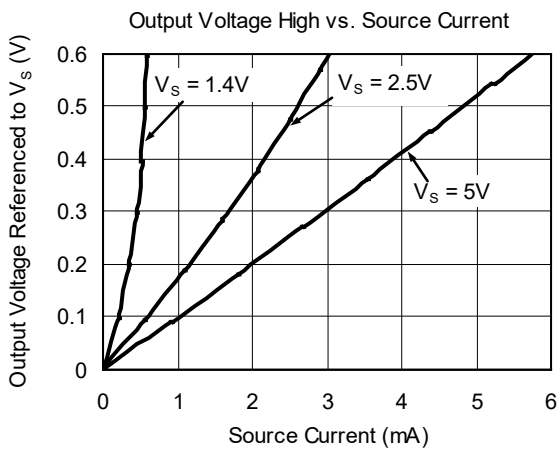
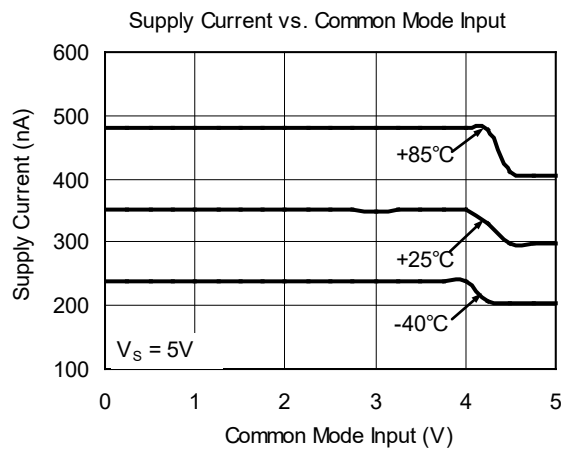
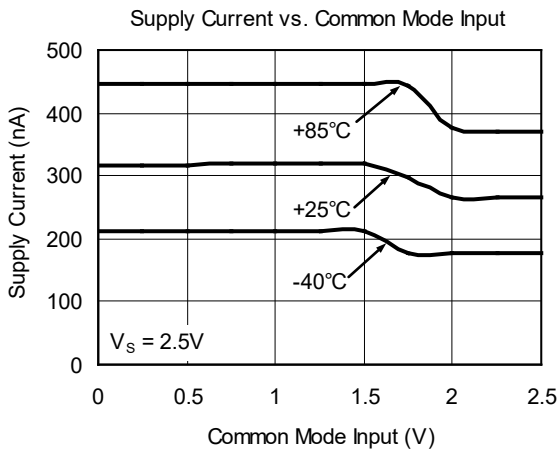
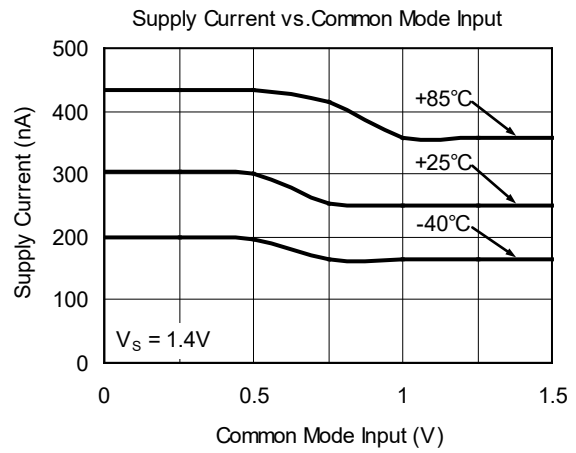
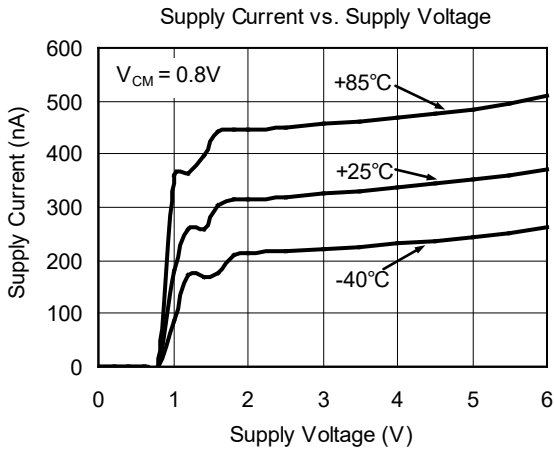

TYPICAL PERFORMANCE CHARACTERISTICS (continued)

Short Circuit Sourcing Current vs. Supply Voltage

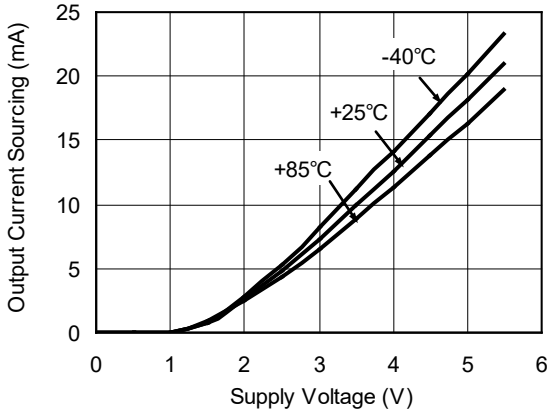

Offset Voltage vs. Common Mode Input

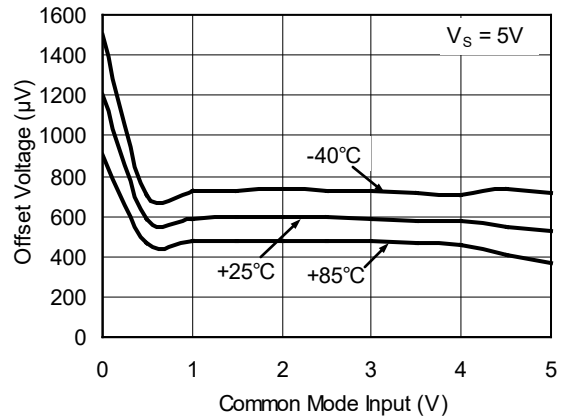

Propagation Delay L-H vs. Common Mode Input

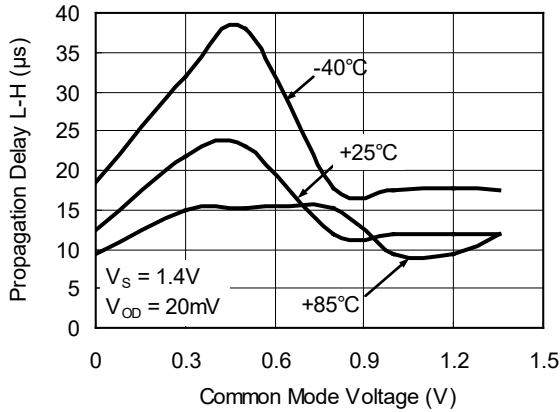

Propagation Delay L-H vs. Common Mode Input

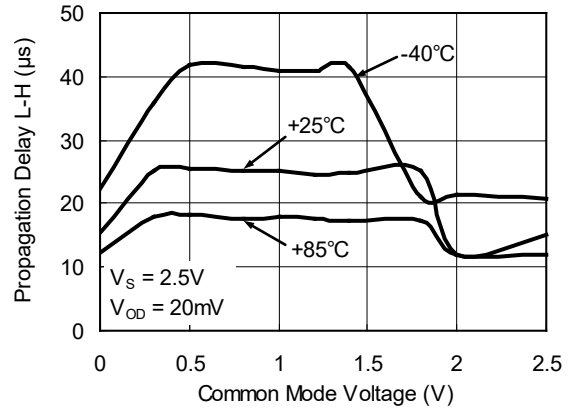

Propagation Delay L-H vs. Common Mode Input

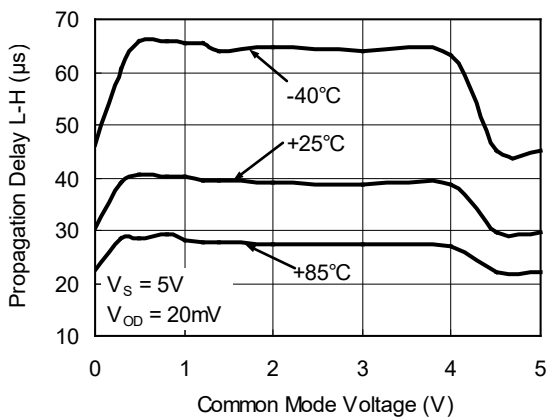

Propagation Delay H-L vs. Common Mode Input

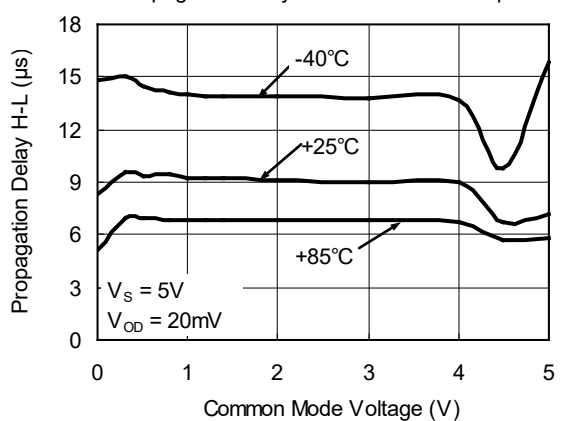

TYPICAL PERFORMANCE CHARACTERISTICS (continued)

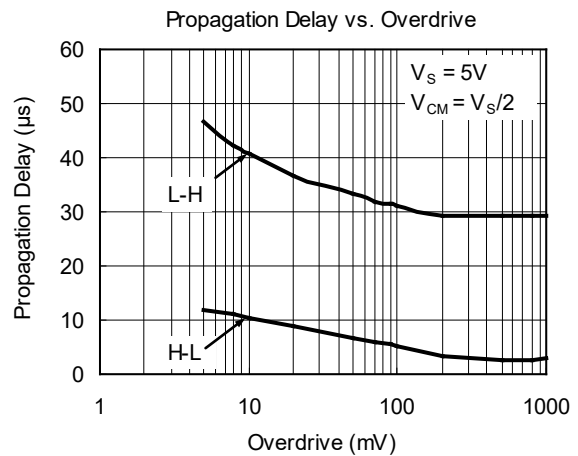
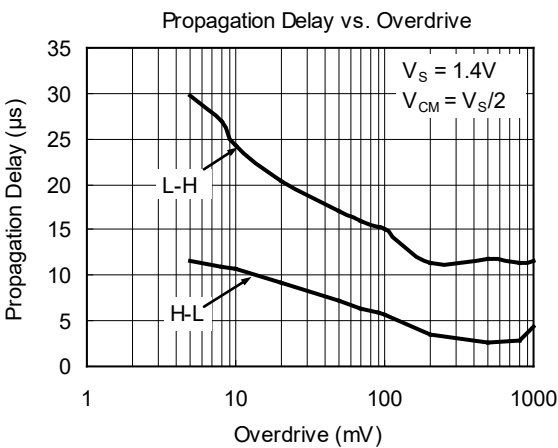
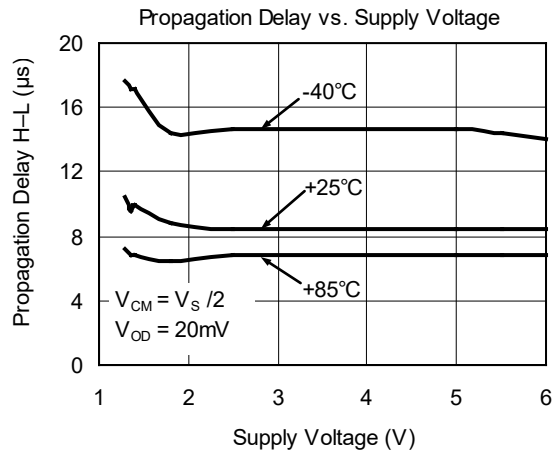
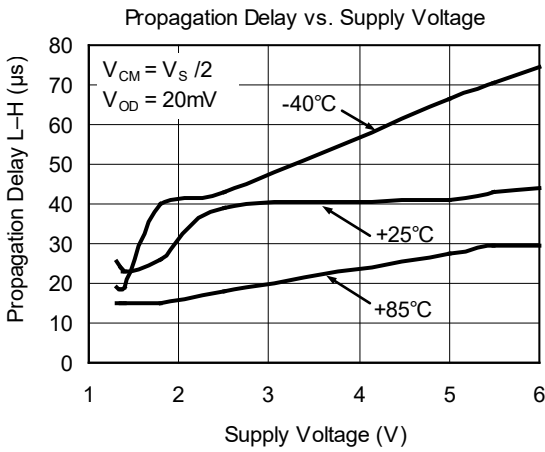
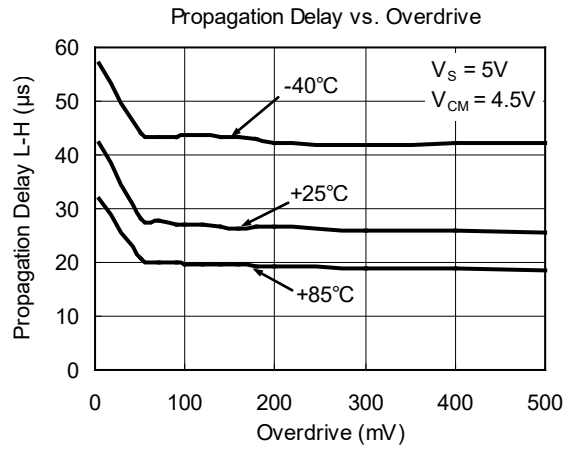
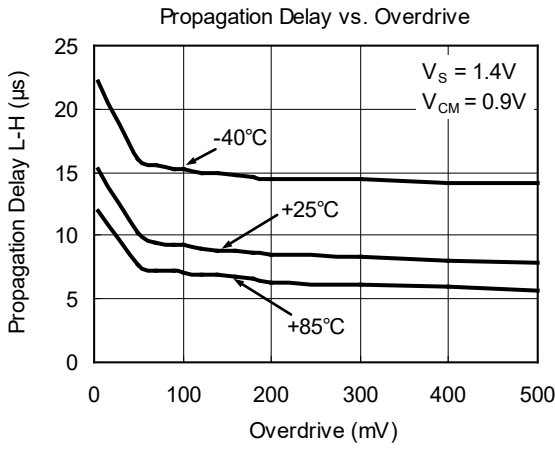



TYPICAL PERFORMANCE CHARACTERISTICS (continued)

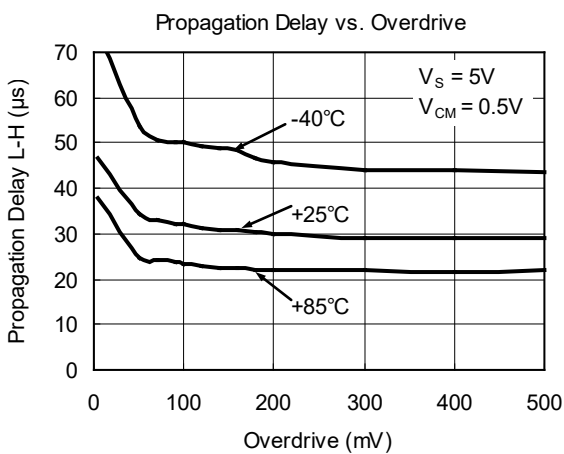
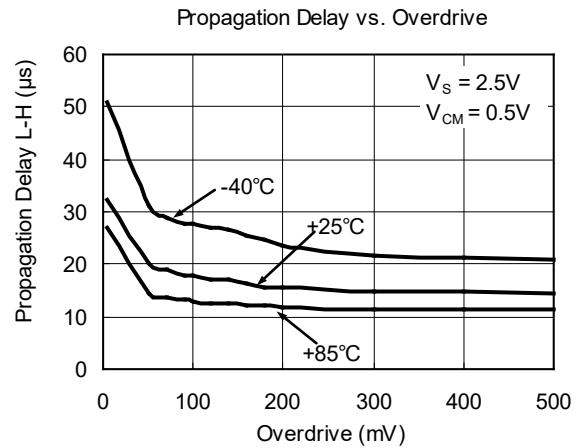
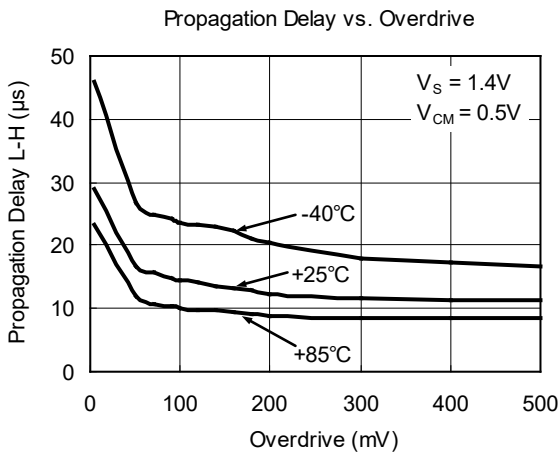
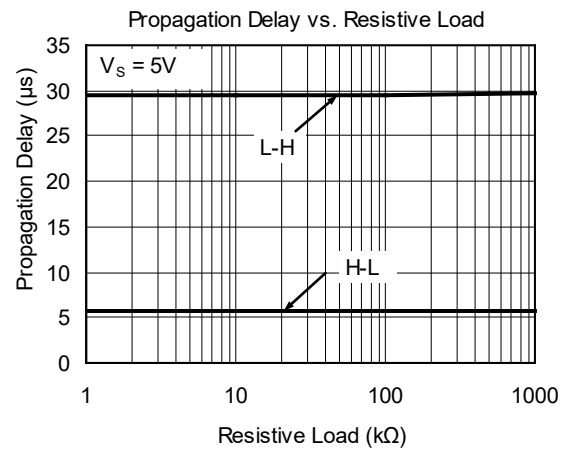
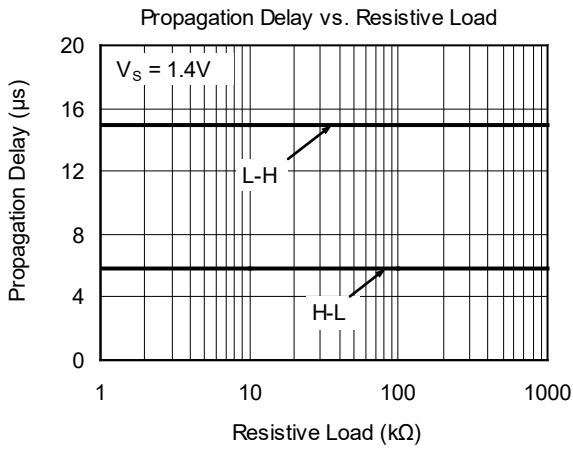

**REVISION HISTORY**

NOTE: Page numbers for previous revisions may differ from page numbers in the current version.

	<b>Page</b>
<b>NOVEMBER 2013 – REV.A.3 to REV.A.4</b>	
Changed Electrical Characteristics section .....	4
<b>NOVEMBER 2013 – REV.A.2 to REV.A.3</b>	
Added Tape and Reel Information section.....	13, 14
<b>JULY 2012 – REV.A.1 to REV.A.2</b>	
Added Typical Application section .....	1
<b>MARCH 2012 – REV.A to REV.A.1</b>	
Changed Electrical Characteristics section .....	3, 4
Added Features section.....	1
<b>Changes from Original (DECEMBER 2011) to REV.A</b>	
Changed from product preview to production data.....	All

# PACKAGE INFORMATION

## PACKAGE OUTLINE DIMENSIONS

### SOT-23-5

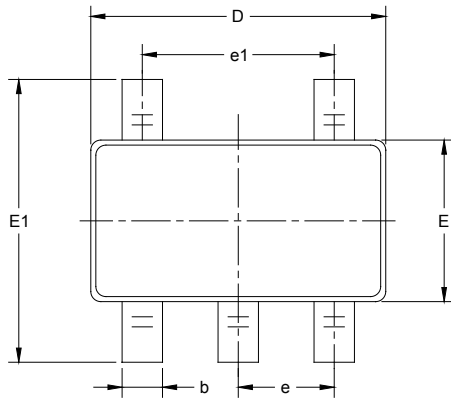

RECOMMENDED LAND PATTERN (Unit: mm)

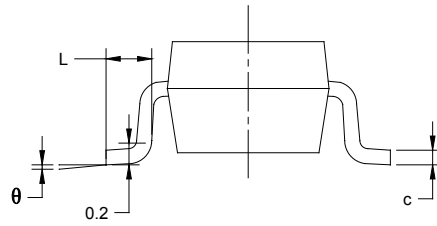
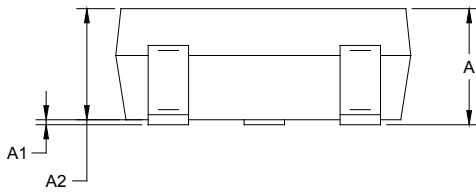

Symbol	Dimensions In Millimeters		Dimensions In Inches	
	MIN	MAX	MIN	MAX
A	1.050	1.250	0.041	0.049
A1	0.000	0.100	0.000	0.004
A2	1.050	1.150	0.041	0.045
b	0.300	0.500	0.012	0.020
c	0.100	0.200	0.004	0.008
D	2.820	3.020	0.111	0.119
E	1.500	1.700	0.059	0.067
E1	2.650	2.950	0.104	0.116
e	0.950 BSC		0.037 BSC	
e1	1.900 BSC		0.075 BSC	
L	0.300	0.600	0.012	0.024
$\theta$	0°	8°	0°	8°

PACKAGE OUTLINE DIMENSIONS

SC70-5

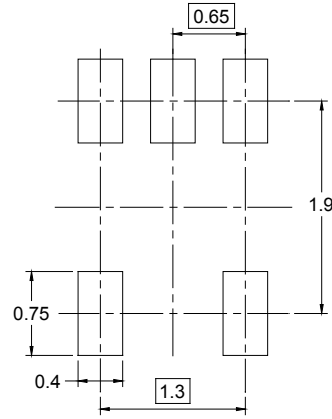
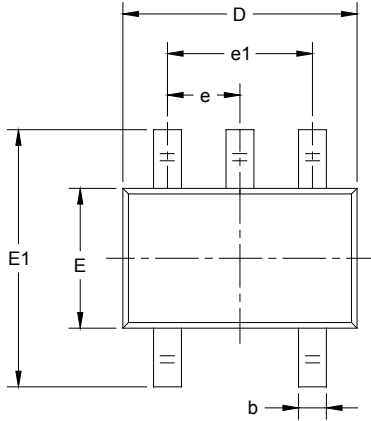

RECOMMENDED LAND PATTERN (Unit: mm)

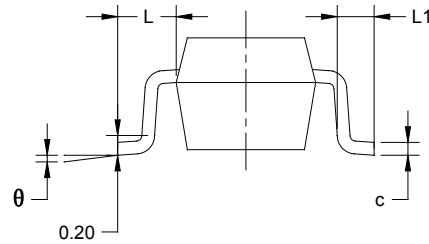
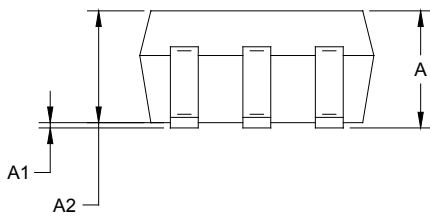

Symbol	Dimensions In Millimeters		Dimensions In Inches	
	MIN	MAX	MIN	MAX
A	0.900	1.100	0.035	0.043
A1	0.000	0.100	0.000	0.004
A2	0.900	1.000	0.035	0.039
b	0.150	0.350	0.006	0.014
c	0.080	0.150	0.003	0.006
D	2.000	2.200	0.079	0.087
E	1.150	1.350	0.045	0.053
E1	2.150	2.450	0.085	0.096
e	0.65 TYP		0.026 TYP	
e1	1.300 BSC		0.051 BSC	
L	0.525 REF		0.021 REF	
L1	0.260	0.460	0.010	0.018
$\theta$	0°	8°	0°	8°

## TAPE AND REEL INFORMATION

### REEL DIMENSIONS

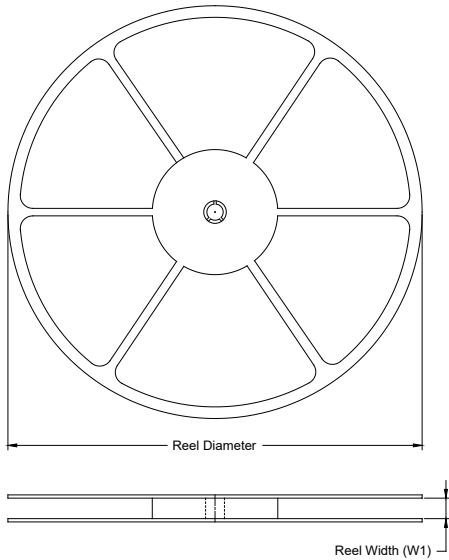

### TAPE DIMENSIONS

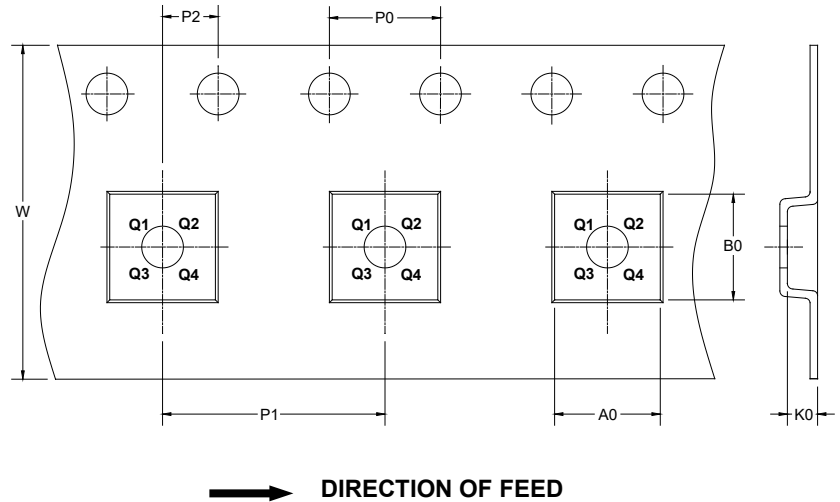

NOTE: The picture is only for reference. Please make the object as the standard.

### KEY PARAMETER LIST OF TAPE AND REEL

Package Type	Reel Diameter	Reel Width W1 (mm)	A0 (mm)	B0 (mm)	K0 (mm)	P0 (mm)	P1 (mm)	P2 (mm)	W (mm)	Pin1 Quadrant
SOT-23-5	7"	9.5	3.20	3.20	1.40	4.0	4.0	2.0	8.0	Q3
SC70-5	7"	9.5	2.25	2.55	1.20	4.0	4.0	2.0	8.0	Q3

000001

# PACKAGE INFORMATION

## CARTON BOX DIMENSIONS



NOTE: The picture is only for reference. Please make the object as the standard.

## KEY PARAMETER LIST OF CARTON BOX

Reel Type	Length (mm)	Width (mm)	Height (mm)	Pizza/Carton
7" (Option)	368	227	224	8
7"	442	410	224	18

DD0002

单击下面可查看定价，库存，交付和生命周期等信息

[>>SGMICRO\(圣邦微电子\)](#)