

## GENERAL DESCRIPTION

The SGM2200H is a high voltage and low power consumption linear regulator. It is capable of supplying 60mA output current. The operating input voltage is up to 36V. The output voltage range is from 1.8V to 5.0V in fixed output version. For adjustable output version, the output voltage can be adjusted from 0.8V to 5.0V by using external resistors.

Other features include current limit and thermal shutdown protection.

The SGM2200H is available in Green SOT-89-3, SOT-23, TSOT-23-5 and SC70-5 packages. It operates over an operating temperature range of -40°C to +85°C.

## FEATURES

- **High Input Voltage: Up to 36V**
- **Fixed Outputs of 1.8V, 2.5V, 3.0V, 3.3V, 3.6V, 5.0V**
- **Adjustable Output from 0.8V to 5.0V**
- **60mA Output Current**
- **Output Voltage Accuracy:  $\pm 2.5\%$  at +25°C**
- **Low Dropout Voltage**
- **Low Power Consumption**
- **Low Temperature Coefficient**
- **Current Limiting and Thermal Protection**
- **-40°C to +85°C Operating Temperature Range**
- **Available in Green SOT-89-3, SOT-23, TSOT-23-5 and SC70-5 Packages**

## APPLICATIONS

Palmtops  
High-Power Boost Applications  
Power Source for Battery-Powered Equipment  
Home Electric/Electronic Appliances

## TYPICAL APPLICATION

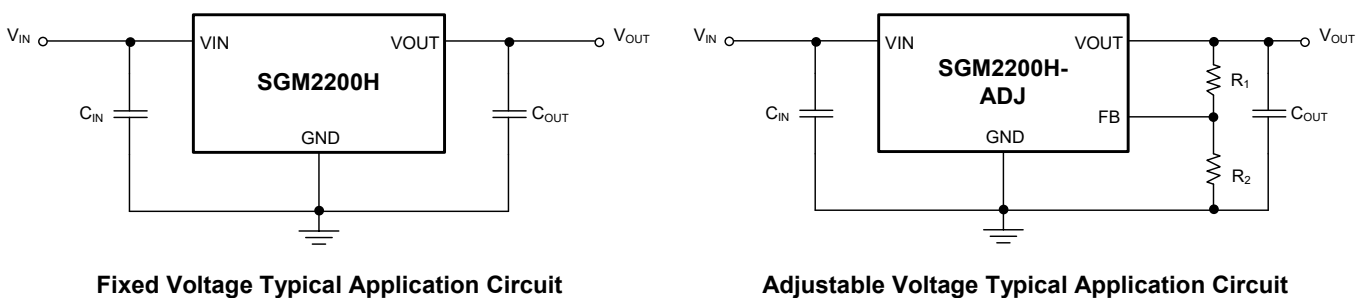

Figure 1. Typical Application Circuits

## PACKAGE/ORDERING INFORMATION

MODEL	PACKAGE DESCRIPTION	SPECIFIED TEMPERATURE RANGE	ORDERING NUMBER	MARKING INFORMATION	PACKING OPTION
SGM2200H-2.5	SOT-89-3	-40°C to +85°C	SGM2200H-2.5YK3G/TR	SY2XX	Tape and Reel, 1000
SGM2200H-3.0	SOT-89-3	-40°C to +85°C	SGM2200H-3.0YK3G/TR	SY3XX	Tape and Reel, 1000
SGM2200H-3.3	SOT-89-3	-40°C to +85°C	SGM2200H-3.3YK3G/TR	SY5XX	Tape and Reel, 1000
SGM2200H-3.6	SOT-89-3	-40°C to +85°C	SGM2200H-3.6YK3G/TR	G1FXX	Tape and Reel, 1000
SGM2200H-5.0	SOT-89-3	-40°C to +85°C	SGM2200H-5.0YK3G/TR	G20XX	Tape and Reel, 1000
SGM2200H-1.8	SOT-23	-40°C to +85°C	SGM2200H-1.8YN3LG/TR	SY1XX	Tape and Reel, 3000
SGM2200H-2.5	SOT-23	-40°C to +85°C	SGM2200H-2.5YN3LG/TR	G25XX	Tape and Reel, 3000
SGM2200H-3.3	SOT-23	-40°C to +85°C	SGM2200H-3.3YN3LG/TR	G27XX	Tape and Reel, 3000
SGM2200H-3.6	SOT-23	-40°C to +85°C	SGM2200H-3.6YN3LG/TR	SY7XX	Tape and Reel, 3000
SGM2200H-5.0	SOT-23	-40°C to +85°C	SGM2200H-5.0YN3LG/TR	G29XX	Tape and Reel, 3000
SGM2200H-2.5	TSOT-23-5	-40°C to +85°C	SGM2200H-2.5YTN5G/TR	G2CXX	Tape and Reel, 3000
SGM2200H-3.3	TSOT-23-5	-40°C to +85°C	SGM2200H-3.3YTN5G/TR	G2FXX	Tape and Reel, 3000
SGM2200H-5.0	TSOT-23-5	-40°C to +85°C	SGM2200H-5.0YTN5G/TR	G32XX	Tape and Reel, 3000
SGM2200H-ADJ	TSOT-23-5	-40°C to +85°C	SGM2200H-ADJYTN5G/TR	G33XX	Tape and Reel, 3000
SGM2200H-1.8	SC70-5	-40°C to +85°C	SGM2200H-1.8YC5G/TR	GF2XX	Tape and Reel, 3000
SGM2200H-2.5	SC70-5	-40°C to +85°C	SGM2200H-2.5YC5G/TR	G36XX	Tape and Reel, 3000
SGM2200H-3.3	SC70-5	-40°C to +85°C	SGM2200H-3.3YC5G/TR	SY6XX	Tape and Reel, 3000
SGM2200H-ADJ	SC70-5	-40°C to +85°C	SGM2200H-ADJYC5G/TR	G3CXX	Tape and Reel, 3000

## MARKING INFORMATION

NOTE: XX = Date Code.

YYY X X

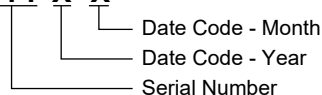

Green (RoHS & HSF): SG Micro Corp defines "Green" to mean Pb-Free (RoHS compatible) and free of halogen substances. If you have additional comments or questions, please contact your SGMICRO representative directly.

**ABSOLUTE MAXIMUM RATINGS**

VIN to GND .....	-0.3V to 44V
VOUT to GND .....	-0.3V to Min(VIN + 0.3V, 6V)
FB to GND .....	-0.3V to Min(VIN + 0.3V, 6V)
Power Dissipation, PD @ TA = +25°C	
SOT-89-3 .....	0.691W
TSOT-23-5 .....	0.429W
SC70-5 .....	0.349W
SOT-23 .....	0.345W
Package Thermal Resistance	
SOT-89-3, θJA .....	152°C/W
SOT-89-3, θJB .....	63°C/W
SOT-89-3, θJC .....	136°C/W
TSOT-23-5, θJA .....	245°C/W
TSOT-23-5, θJB .....	174°C/W
TSOT-23-5, θJC .....	207°C/W
SC70-5, θJA .....	301°C/W
SC70-5, θJB .....	158°C/W
SC70-5, θJC .....	211°C/W
SOT-23, θJA .....	304°C/W
SOT-23, θJB .....	209°C/W
SOT-23, θJC .....	218°C/W
Junction Temperature .....	+150°C
Storage Temperature Range .....	-65°C to +150°C
Lead Temperature (Soldering, 10s) .....	+260°C
ESD Susceptibility	
Fixed Voltage Version:	
HBM .....	4000V
CDM .....	1000V
Adjustable Voltage Version:	
HBM .....	3000V
CDM .....	1000V

**RECOMMENDED OPERATING CONDITIONS**

Input Voltage Range .....	2.7V to 36V
Operating Temperature Range .....	-40°C to +85°C

**OVERSTRESS CAUTION**

Stresses beyond those listed in Absolute Maximum Ratings may cause permanent damage to the device. Exposure to absolute maximum rating conditions for extended periods may affect reliability. Functional operation of the device at any conditions beyond those indicated in the Recommended Operating Conditions section is not implied.

**ESD SENSITIVITY CAUTION**

This integrated circuit can be damaged if ESD protections are not considered carefully. SGMICRO recommends that all integrated circuits be handled with appropriate precautions. Failure to observe proper handling and installation procedures can cause damage. ESD damage can range from subtle performance degradation to complete device failure. Precision integrated circuits may be more susceptible to damage because even small parametric changes could cause the device not to meet the published specifications.

**DISCLAIMER**

SG Micro Corp reserves the right to make any change in circuit design, or specifications without prior notice.

PIN CONFIGURATIONS

SGM2200H-Fixed Output (TOP VIEW)

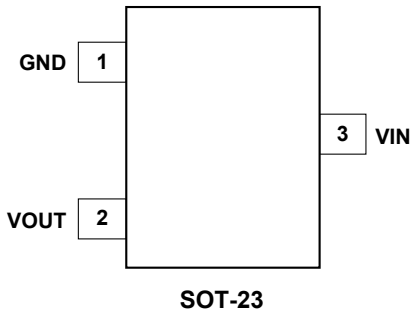

SGM2200H-Fixed Output (TOP VIEW)

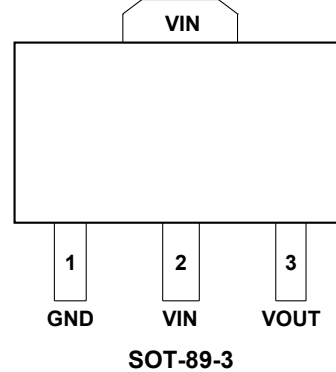

SGM2200H-Fixed Output (TOP VIEW)

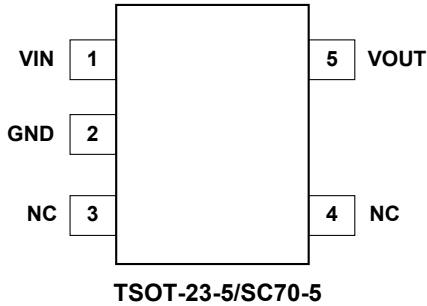

SGM2200H-ADJ (TOP VIEW)

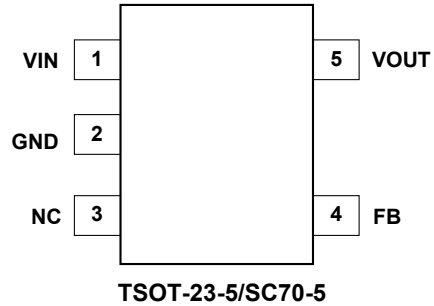

PIN DESCRIPTION

PIN			NAME	FUNCTION
TSOT-23-5/ SC70-5	SOT-23	SOT-89-3		
1	3	2	VIN	Input Supply Voltage Pin. It is recommended to use a 1μF or larger ceramic capacitor from VIN pin to ground to get good power supply decoupling. This ceramic capacitor should be placed as close as possible to VIN pin.
2	1	1	GND	Ground.
3	-	-	NC	No Connection.
4	-	-	FB	Feedback Voltage Input Pin (adjustable voltage version only). Connect this pin to the midpoint of an external resistor divider to adjust the output voltage. Place the resistors as close as possible to this pin.
			NC	No Connection. (Fixed voltage version only).
5	2	3	VOUT	Regulator Output Pin. It is recommended to use a ceramic capacitor with effective capacitance in the range of 1μF to 10μF to ensure stability. This ceramic capacitor should be placed as close as possible to VOUT pin.

## ELECTRICAL CHARACTERISTICS

(V<sub>IN</sub> = 15V, C<sub>IN</sub> = C<sub>OUT</sub> = 1μF, Full = -40°C to +85°C, typical values are at T<sub>A</sub> = +25°C, unless otherwise noted.)

PARAMETER	SYMBOL	CONDITIONS	TEMP	MIN	TYP	MAX	UNITS
Input Voltage	V <sub>IN</sub>	V <sub>OUT</sub> < 3.3V	Full	2.7		28	V
		V <sub>OUT</sub> ≥ 3.3V	Full	2.7		36	
Output Voltage Accuracy		I <sub>OUT</sub> = 1mA	+25°C	-2.5		2.5	%
Feedback Voltage	V <sub>FB</sub>	SGM2200H-ADJ, V <sub>FB</sub> = V <sub>OUT</sub> , I <sub>OUT</sub> = 1mA	+25°C		0.8		V
FB Input Current	I <sub>FB</sub>	SGM2200H-ADJ, V <sub>FB</sub> = 0.9V	Full	-15		15	nA
Ground Pin Current		No load	+25°C		2.2	2.8	μA
			Full			3.2	
Maximum Output Current		V <sub>IN</sub> = V <sub>OUT</sub> + 2V or 4V, whichever is greater	+25°C	60			mA
Dropout Voltage <sup>(1)</sup>	V <sub>DROP</sub>	I <sub>OUT</sub> = 60mA, V <sub>OUT</sub> ≥ 2.5V	+25°C		1600	2100	mV
			Full			2650	
Line Regulation	$\frac{\Delta V_{OUT}}{\Delta V_{IN} \times V_{OUT}}$	V <sub>IN</sub> = V <sub>OUT</sub> + 2V or 4V to 28V, I <sub>OUT</sub> = 1mA, V <sub>OUT</sub> < 3.3V	+25°C		0.005	0.025	%V
		V <sub>IN</sub> = V <sub>OUT</sub> + 2V to 36V, I <sub>OUT</sub> = 1mA, V <sub>OUT</sub> ≥ 3.3V	+25°C		0.005	0.025	
Load Regulation	$\Delta V_{OUT}$	V <sub>IN</sub> = V <sub>OUT</sub> + 2V or 4V, I <sub>OUT</sub> = 1mA to 60mA	+25°C		15	35	mV
Output Voltage Temperature Coefficient	$\frac{\Delta V_{OUT}}{\Delta T_A \times V_{OUT}}$	V <sub>IN</sub> = V <sub>OUT</sub> + 2V or 4V, I <sub>OUT</sub> = 1mA	Full		65		ppm/°C

## NOTES:

1. The dropout voltage is defined as V<sub>IN</sub> - V<sub>OUT</sub>, when V<sub>OUT</sub> is 95% of the value of V<sub>OUT</sub> for V<sub>IN</sub> = V<sub>OUT</sub> + 2V.

TYPICAL PERFORMANCE CHARACTERISTICS

T<sub>A</sub> = +25°C, V<sub>IN</sub> = 5.3V, V<sub>OUT</sub> = 3.3V, C<sub>IN</sub> = C<sub>OUT</sub> = 1μF, unless otherwise noted.

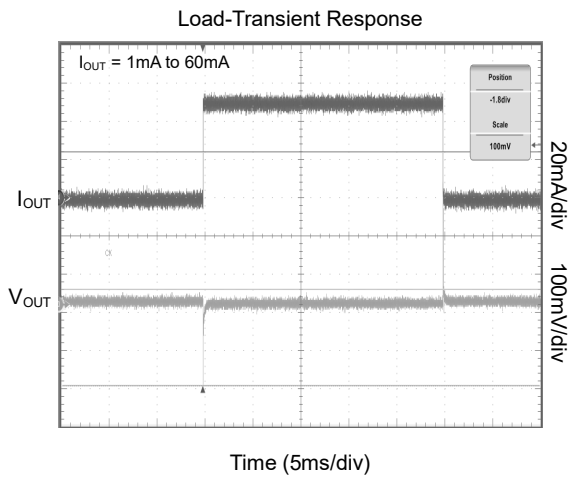
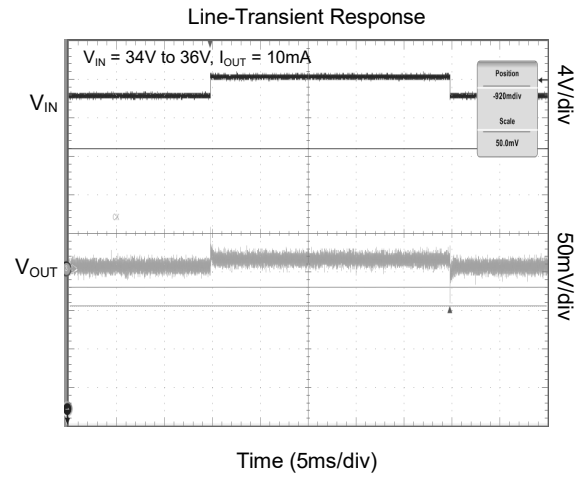
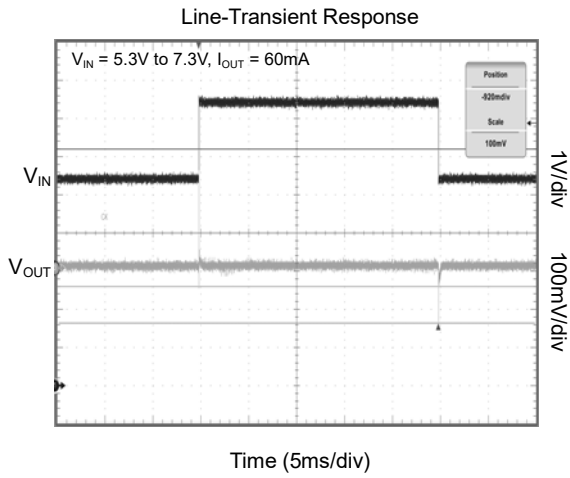

TYPICAL PERFORMANCE CHARACTERISTICS (continued)

T<sub>A</sub> = +25°C, V<sub>IN</sub> = 5.3V, V<sub>OUT</sub> = 3.3V, C<sub>IN</sub> = C<sub>OUT</sub> = 1μF, unless otherwise noted.

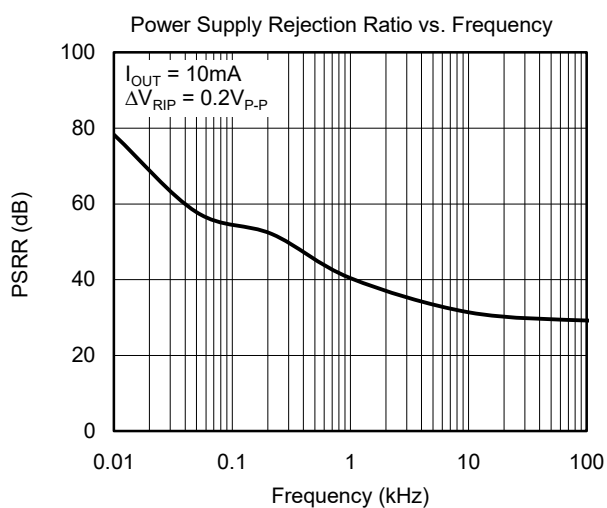
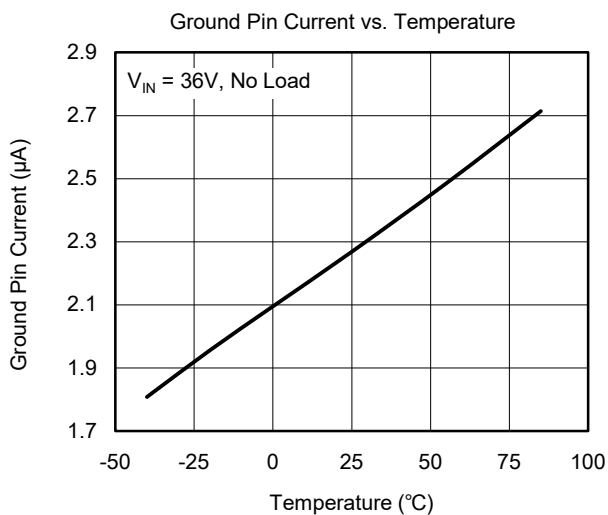
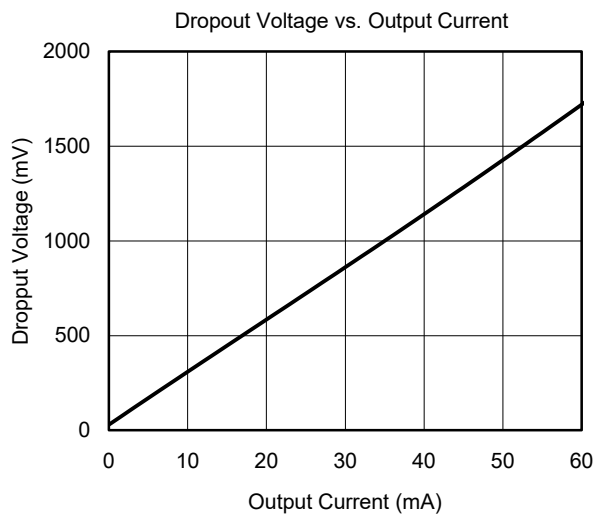
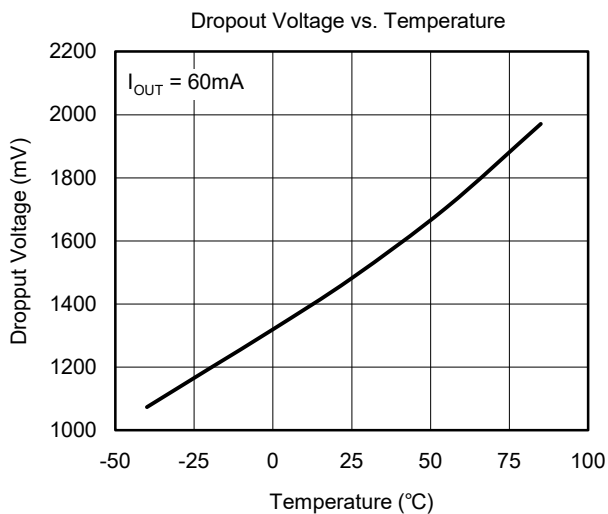

**APPLICATION INFORMATION**

**Input Capacitor Selection (C<sub>IN</sub>)**

The input decoupling capacitor should be placed as close as possible to the IN pin for ensuring the device stability. A 1µF X7R or X5R ceramic capacitor is selected to get good dynamic performance.

When V<sub>IN</sub> is required to provide large current instantaneously, a large effective input capacitor is required. Multiple input capacitors can limit the input tracking inductance. Adding more input capacitors is available to restrict the ringing and to keep it below the device absolute maximum ratings.

**Output Capacitor Selection (C<sub>OUT</sub>)**

The output capacitor should be placed as close as possible to the OUT pin. A 1µF to 10µF X7R or X5R ceramic capacitor is selected to get good dynamic performance. For ceramic capacitor, temperature, DC bias and package size will change the effective capacitance, so enough margin of C<sub>OUT</sub> must be considered in design. Additionally, C<sub>OUT</sub> with larger capacitance and lower ESR will help increase the high frequency PSRR and improve the load transient response.

**Adjustable Regulator**

The output voltage of the SGM2200H-ADJ can be adjusted from 0.8V to 5.0V. The FB pin will be connected to two external resistors as shown in Figure 2. The output voltage is determined by the following equation:

$$V_{OUT} = V_{FB} \times \left( 1 + \frac{R_1}{R_2} \right) \tag{1}$$

where:

V<sub>OUT</sub> is output voltage and V<sub>FB</sub> is the internal voltage reference, V<sub>FB</sub> = 0.8V. Use R<sub>2</sub> = 2MΩ to maintain a 0.4µA minimum load.

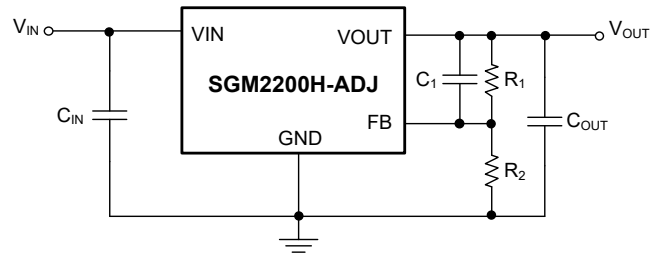

Figure 2. Adjustable Output Voltage Application

**Thermal Shutdown**

The SGM2200H can detect the temperature of die. When the die temperature exceeds the threshold value of thermal shutdown, the SGM2200H will be in shutdown state.

**REVISION HISTORY**

NOTE: Page numbers for previous revisions may differ from page numbers in the current version.

MAY 2023 – REV.A.3 to REV.A.4	Page
Updated Package Outline Dimensions.....	12
JULY 2022 – REV.A.2 to REV.A.3	Page
Updated Package Thermal Resistance.....	3
OCTOBER 2020 – REV.A.1 to REV.A.2	Page
Updated Package/Ordering Information section.....	2
OCTOBER 2017 – REV.A to REV.A.1	Page
Changed the marking information for SGM2200H-1.8YC5G.....	3
Changes from Original (APRIL 2017) to REV.A	Page
Changed from product preview to production data.....	All



PACKAGE OUTLINE DIMENSIONS

SOT-89-3

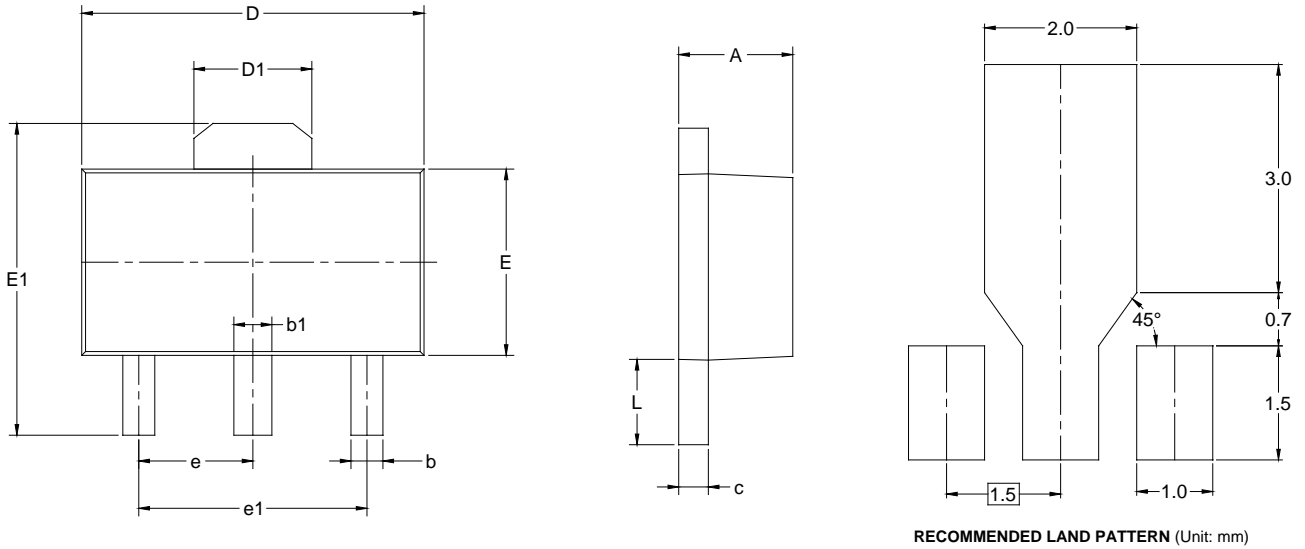

RECOMMENDED LAND PATTERN (Unit: mm)

Symbol	Dimensions In Millimeters		Dimensions In Inches	
	MIN	MAX	MIN	MAX
A	1.400	1.600	0.055	0.063
b	0.320	0.520	0.013	0.020
b1	0.400	0.580	0.016	0.023
c	0.350	0.440	0.014	0.017
D	4.400	4.600	0.173	0.181
D1	1.550 REF		0.061 REF	
E	2.300	2.600	0.091	0.102
E1	3.940	4.250	0.155	0.167
e	1.500 TYP		0.060 TYP	
e1	3.000 TYP		0.118 TYP	
L	0.900	1.200	0.035	0.047

NOTES:

1. Body dimensions do not include mode flash or protrusion.
2. This drawing is subject to change without notice.

PACKAGE OUTLINE DIMENSIONS

SOT-23

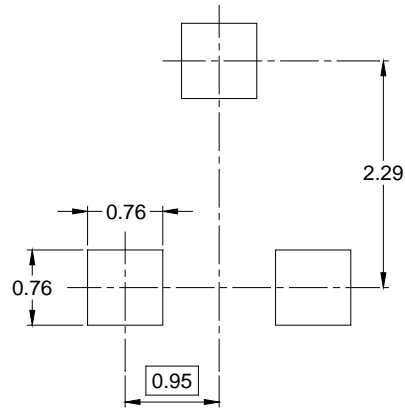
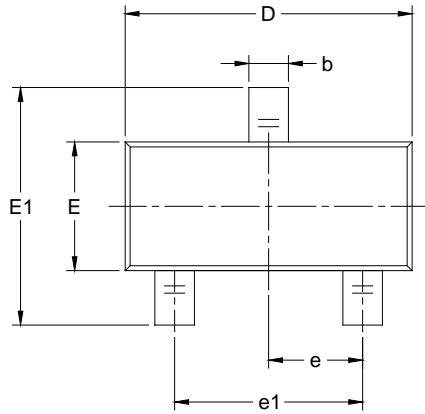

RECOMMENDED LAND PATTERN (Unit: mm)

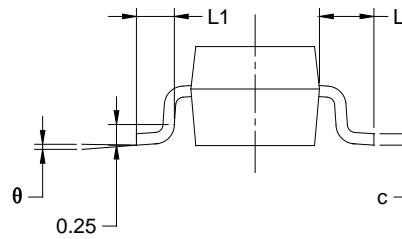
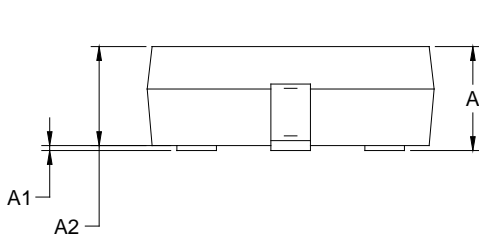

Symbol	Dimensions In Millimeters		Dimensions In Inches	
	MIN	MAX	MIN	MAX
A	0.900	1.150	0.035	0.045
A1	0.000	0.100	0.000	0.004
A2	0.900	1.050	0.035	0.041
b	0.300	0.500	0.012	0.020
c	0.080	0.150	0.003	0.006
D	2.800	3.000	0.110	0.118
E	1.200	1.400	0.047	0.055
E1	2.250	2.550	0.089	0.100
e	0.950 BSC		0.037 BSC	
e1	1.900 BSC		0.075 BSC	
L	0.550 REF		0.022 REF	
L1	0.300	0.500	0.012	0.020
θ	0°	8°	0°	8°

NOTES:

1. Body dimensions do not include mode flash or protrusion.
2. This drawing is subject to change without notice.

PACKAGE OUTLINE DIMENSIONS

TSOT-23-5

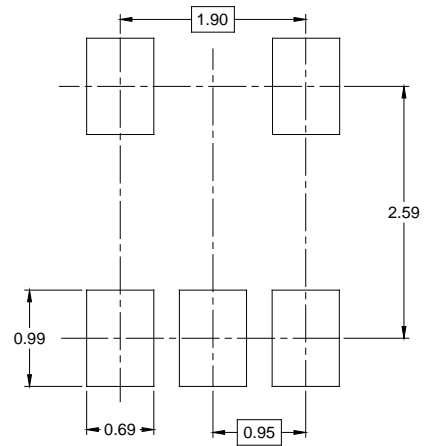
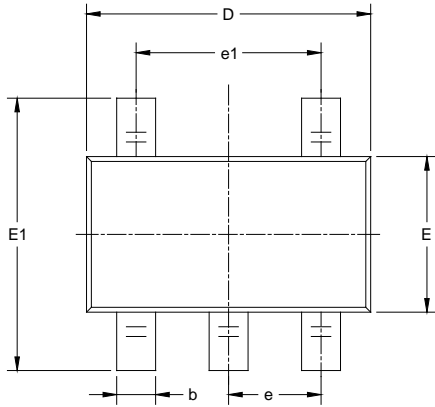

RECOMMENDED LAND PATTERN (Unit: mm)

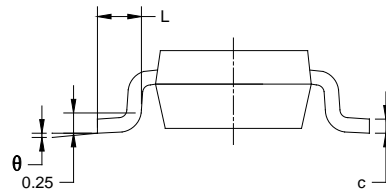
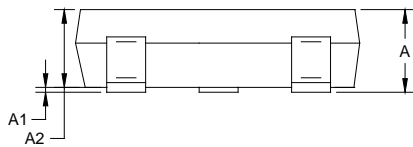

Symbol	Dimensions In Millimeters		Dimensions In Inches	
	MIN	MAX	MIN	MAX
A	0.700	0.900	0.028	0.035
A1	0.000	0.100	0.000	0.004
A2	0.700	0.800	0.028	0.031
b	0.350	0.500	0.014	0.020
c	0.080	0.200	0.003	0.008
D	2.820	3.020	0.111	0.119
E	1.600	1.700	0.063	0.067
E1	2.650	2.950	0.104	0.116
e	0.950 BSC		0.037 BSC	
e1	1.900 BSC		0.075 BSC	
L	0.300	0.600	0.012	0.024
$\theta$	0°	8°	0°	8°

NOTES:

1. Body dimensions do not include mode flash or protrusion.
2. This drawing is subject to change without notice.

PACKAGE OUTLINE DIMENSIONS

SC70-5

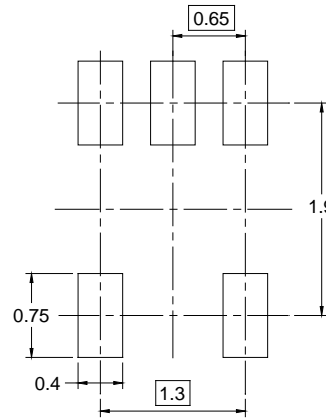
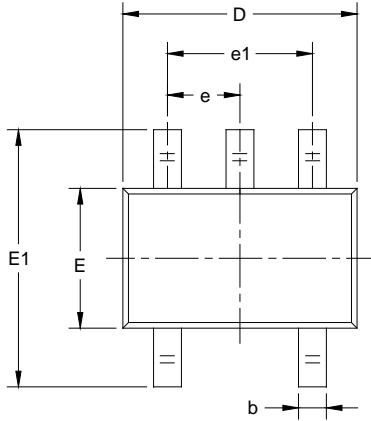

RECOMMENDED LAND PATTERN (Unit: mm)

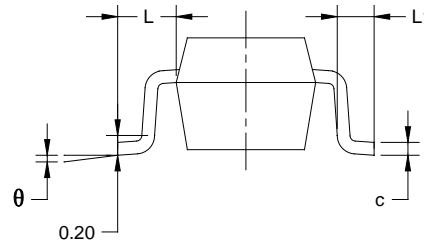
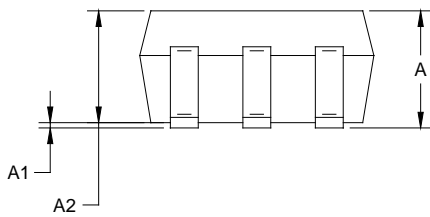

Symbol	Dimensions In Millimeters		Dimensions In Inches	
	MIN	MAX	MIN	MAX
A	0.800	1.100	0.031	0.043
A1	0.000	0.100	0.000	0.004
A2	0.800	1.000	0.031	0.039
b	0.150	0.350	0.006	0.014
c	0.080	0.220	0.003	0.009
D	2.000	2.200	0.079	0.087
E	1.150	1.350	0.045	0.053
E1	2.150	2.450	0.085	0.096
e	0.65 TYP		0.026 TYP	
e1	1.300 BSC		0.051 BSC	
L	0.525 REF		0.021 REF	
L1	0.260	0.460	0.010	0.018
$\theta$	0°	8°	0°	8°

NOTES:

1. Body dimensions do not include mode flash or protrusion.
2. This drawing is subject to change without notice.

# PACKAGE INFORMATION

## TAPE AND REEL INFORMATION

### REEL DIMENSIONS



### TAPE DIMENSIONS



NOTE: The picture is only for reference. Please make the object as the standard.

### KEY PARAMETER LIST OF TAPE AND REEL

Package Type	Reel Diameter	Reel Width W1 (mm)	A0 (mm)	B0 (mm)	K0 (mm)	P0 (mm)	P1 (mm)	P2 (mm)	W (mm)	Pin1 Quadrant
SOT-89-3	7"	13.2	4.85	4.45	1.85	4.0	8.0	2.0	12.0	Q3
SOT-23	7"	9.5	3.15	2.77	1.22	4.0	4.0	2.0	8.0	Q3
TSOT-23-5	7"	9.5	3.17	3.10	1.10	4.0	4.0	2.0	8.0	Q3
SC70-5	7"	9.5	2.40	2.50	1.20	4.0	4.0	2.0	8.0	Q3

DD0001

# PACKAGE INFORMATION

## CARTON BOX DIMENSIONS



NOTE: The picture is only for reference. Please make the object as the standard.

## KEY PARAMETER LIST OF CARTON BOX

Reel Type	Length (mm)	Width (mm)	Height (mm)	Pizza/Carton
7" (Option)	368	227	224	8
7"	442	410	224	18

DD0002

单击下面可查看定价，库存，交付和生命周期等信息

[>>SGMICRO\(圣邦微电子\)](#)