



SGM4812

132mW Differential Input, Stereo Audio Power Amplifier

GENERAL DESCRIPTION

The SGM4812 is a stereo audio power amplifier with active high shutdown mode. It is designed to maximize audio performance in portable applications. The audio power amplifier is designed for the portable application that needs low-component count and can operate from a single 2.7V to 5.5V power supply. Under the condition of using a 5.0V power supply to drive a 16Ω speaker, it can deliver a continuous average power of 132mW per channel, and the distortion (THD+N) is typically 0.1%.

No external compensation is required for the amplifier gain, which is externally configured through two resistors for each input channel.

The SGM4812 provides an active-high, micro-power consumption shutdown mode which is controlled externally and an internal thermal shutdown protection.

The SGM4812 is available in a Green MSOP-10 package. It operates over an ambient temperature range of -40°C to +85°C.

FEATURES

- **Supply Voltage Range: 2.7V to 5.5V**
- **Dual Channel, Differential Inputs**
- **132mW into 16Ω Load from 5V Power Supply at THD+N = 0.1% (Typical, per Channel)**
- **88mW into 32Ω Load from 5V Power Supply at THD+N = 0.1% (Typical, per Channel)**
- **Low Shutdown Current: 0.36μA (TYP) at 5V**
- **Shutdown Pin is Compatible with 1.8V Logic**
- **Internal Pop Reduction Circuitry**
- **Thermal Shutdown and Short Circuit Protection**
- **Internal Mid-Rail Generation**
- **-40°C to +85°C Operating Temperature Range**
- **Available in a Green MSOP-10 Package**

APPLICATIONS

Mobile Phone
Portable Electronic Systems
Notebook Computers
PDAs
GPS

PACKAGE/ORDERING INFORMATION

MODEL	PACKAGE DESCRIPTION	SPECIFIED TEMPERATURE RANGE	ORDERING NUMBER	PACKAGE MARKING	PACKING OPTION
SGM4812	MSOP-10	-40°C to +85°C	SGM4812YMS10/TR	SGM4812 YMS10 XXXXX	Tape and Reel, 4000

MARKING INFORMATION

NOTE: XXXXX = Date Code and Vendor Code.

XXXXX

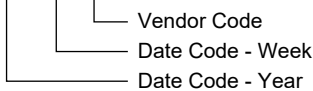

Green (RoHS & HSF): SG Micro Corp defines "Green" to mean Pb-Free (RoHS compatible) and free of halogen substances. If you have additional comments or questions, please contact your SGMICRO representative directly.

ABSOLUTE MAXIMUM RATINGS

- Supply Voltage.....6V
- Input Voltage Range -0.3V to (V₊) + 0.3V
- Junction Temperature+150°C
- Storage Temperature Range.....-65°C to +150°C
- Lead Temperature (Soldering, 10s)+260°C
- ESD Susceptibility
- HBM.....4000V
- MM.....400V

RECOMMENDED OPERATING CONDITIONS

- Supply Voltage Range2.7V to 5.5V
- Operating Temperature Range-40°C to +85°C

PIN CONFIGURATION

(TOP VIEW)

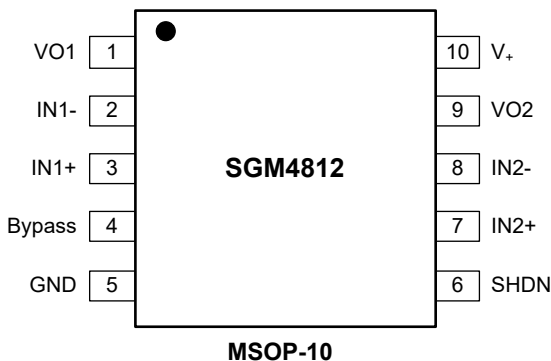

OVERSTRESS CAUTION

Stresses beyond those listed in Absolute Maximum Ratings may cause permanent damage to the device. Exposure to absolute maximum rating conditions for extended periods may affect reliability. Functional operation of the device at any conditions beyond those indicated in the Recommended Operating Conditions section is not implied.

ESD SENSITIVITY CAUTION

This integrated circuit can be damaged if ESD protections are not considered carefully. SGMICRO recommends that all integrated circuits be handled with appropriate precautions. Failure to observe proper handling and installation procedures can cause damage. ESD damage can range from subtle performance degradation to complete device failure. Precision integrated circuits may be more susceptible to damage because even small parametric changes could cause the device not to meet the published specifications.

DISCLAIMER

SG Micro Corp reserves the right to make any change in circuit design, or specifications without prior notice.

ELECTRICAL CHARACTERISTICS

(T_A = +25°C, unless otherwise specified.)

PARAMETER	SYMBOL	CONDITIONS		MIN	TYP	MAX	UNITS
Supply Voltage	V ₊			2.7		5.5	V
Shutdown Current	I _{SD}	V _{IN} = 0V, V _{SHDN} = V ₊	V ₊ = 5V		0.36	2	μA
			V ₊ = 3.3V		0.13	2	
			V ₊ = 2.7V		0.07		
Output Offset Voltage	V _{OS}	V _{IN} = 0V		-15	2	15	mV
Quiescent Power Supply Current	I _Q	V _{IN} = 0V, I _O = 0A	V ₊ = 5V		1.86	2.6	mA
			V ₊ = 3.3V		1.58	2.5	
			V ₊ = 2.7V		1.50		
Shutdown Voltage Input High	V _{SDIH}			1.8			V
Shutdown Voltage Input Low	V _{SDIL}					0.4	
Power Supply Rejection Ratio	PSRR	V ₊ = 3.2V to 3.4V			74		dB
		V ₊ = 4.9V to 5.1V			70		
Output Power (per Channel)	P _O	f = 1kHz, THD+N = 0.1%	V ₊ = 5V	R _L = 16Ω		132	mW
				R _L = 32Ω		82	
			V ₊ = 3.3V	R _L = 16Ω		46	
				R _L = 32Ω		34	
			V ₊ = 3.0V	R _L = 16Ω		34	
				R _L = 32Ω		27	
			V ₊ = 2.7V	R _L = 16Ω		22	
				R _L = 32Ω		21	
Total Harmonic Distortion + Noise	THD+N	P _O = 60mW, V ₊ = 5V, R _L = 32Ω, f = 20Hz to 20kHz			0.07		%
Power Supply Rejection Ratio	PSRR	f = 217Hz, R _L = 32Ω, Input grounded with 10Ω, (C _{BYPASS} = 0.47μF)	V ₊ = 5V		-55	dB	
			V ₊ = 3.3V		-55		
			V ₊ = 3.0V		-55		
			V ₊ = 2.7V		-55		
		f = 1kHz, R _L = 32Ω, Input grounded with 10Ω, (C _{BYPASS} = 0.47μF)	V ₊ = 5V		-71		
			V ₊ = 3.3V		-71		
			V ₊ = 3.0V		-71		
			V ₊ = 2.7V		-71		
Wake-Up Time	T _{WU}	V ₊ = 5V, C _{BYPASS} = 0.47μF			1.8		s
Signal-to-Noise Ratio	SNR	V ₊ = 5V, R _L = 32Ω, P _O = 60mW, BW < 80kHz			-96		dB
Crosstalk	X _{TALK}	V ₊ = 5V, R _L = 32Ω, P _O = 60mW, f = 1kHz			-75		dB

TYPICAL PERFORMANCE CHARACTERISTICS

Small Signal Step Response

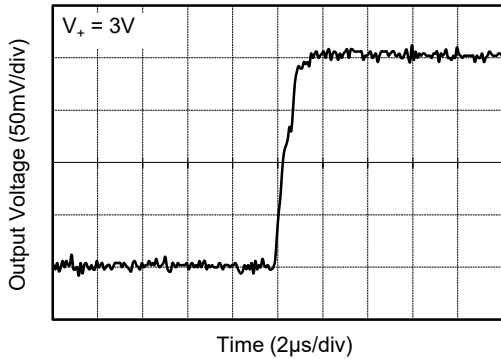

Small Signal Step Response

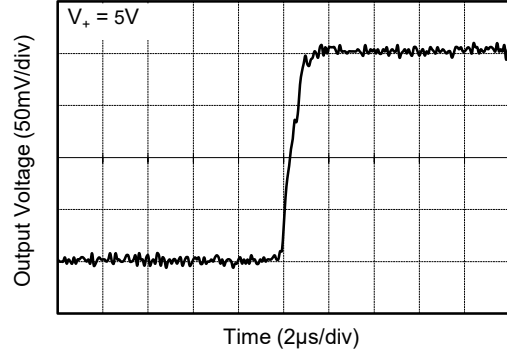

THD+N vs. Frequency

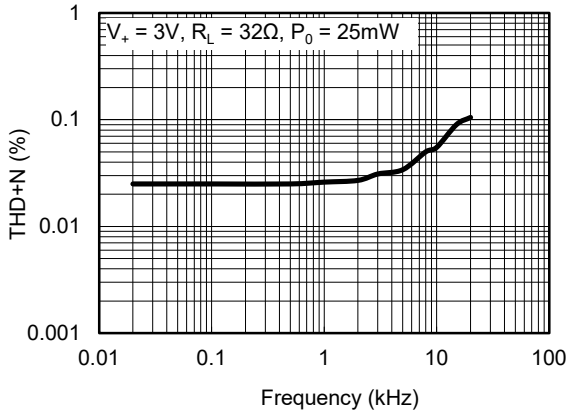

THD+N vs. Frequency

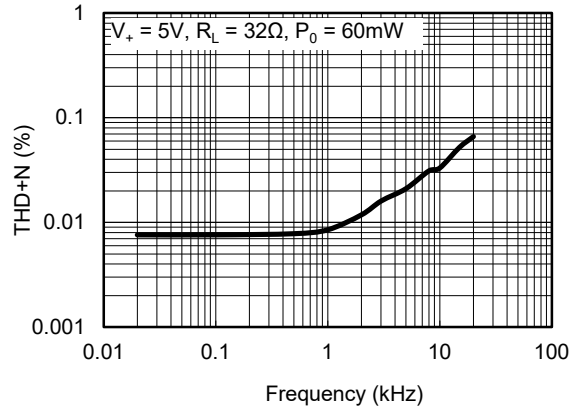

THD+N vs. Frequency

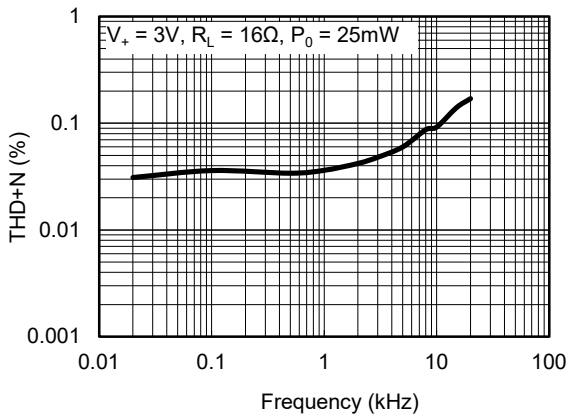

THD+N vs. Frequency

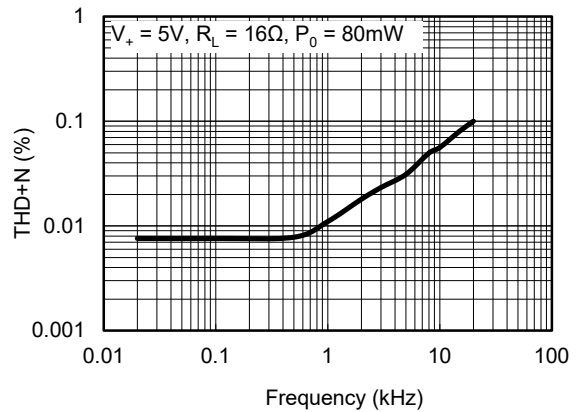

TYPICAL PERFORMANCE CHARACTERISTICS (continued)

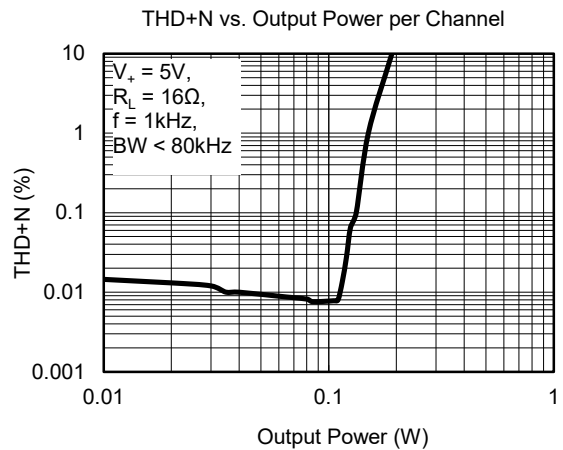
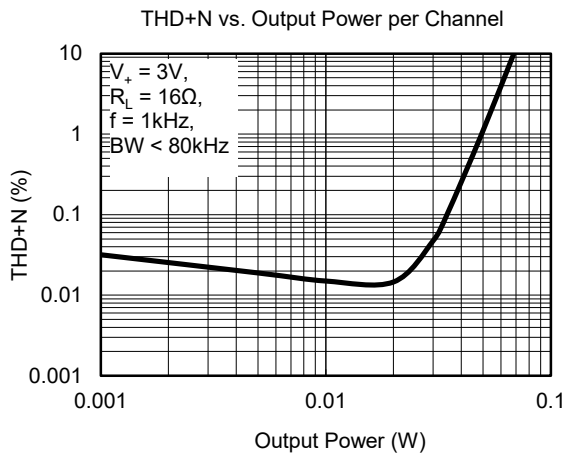
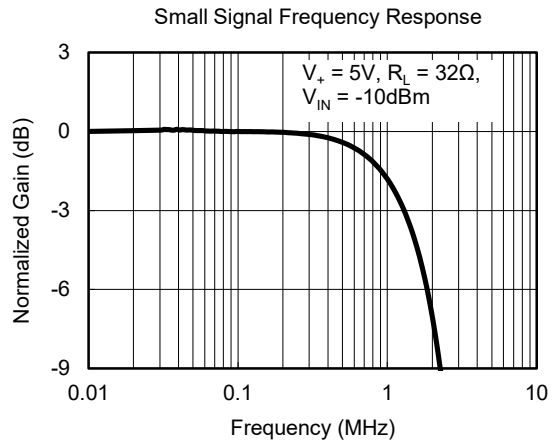
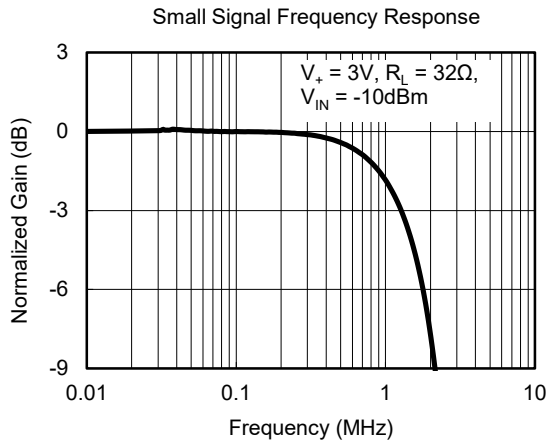
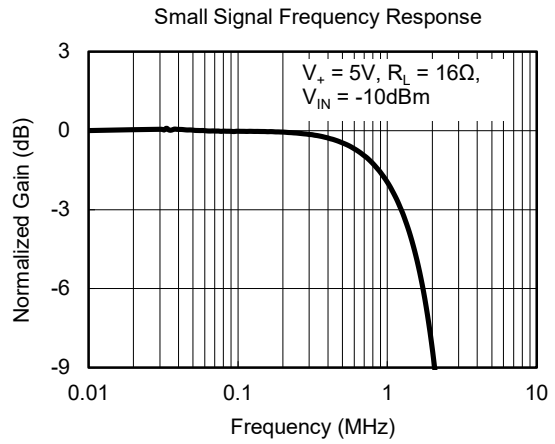
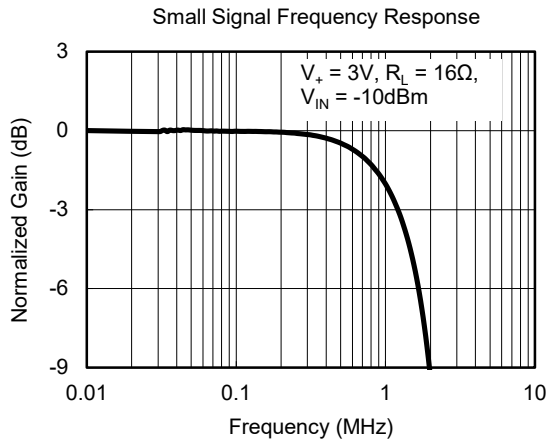

TYPICAL PERFORMANCE CHARACTERISTICS (continued)

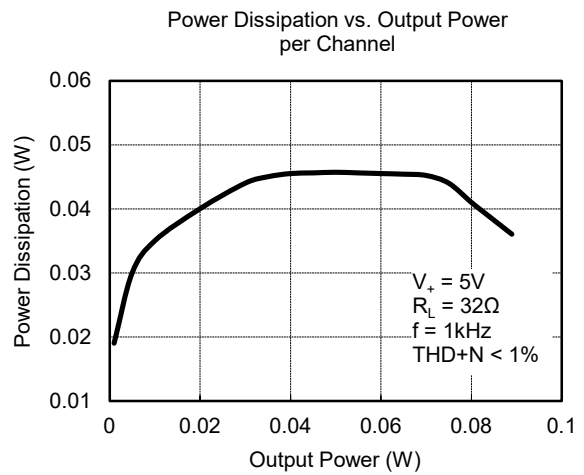
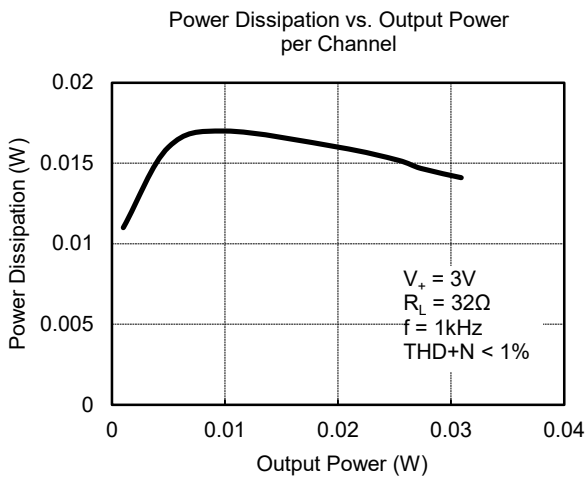
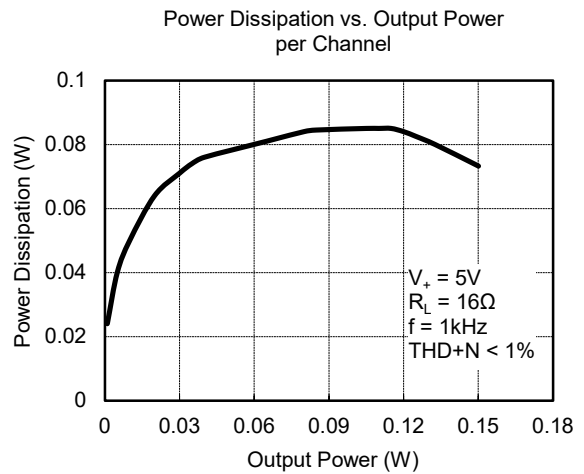
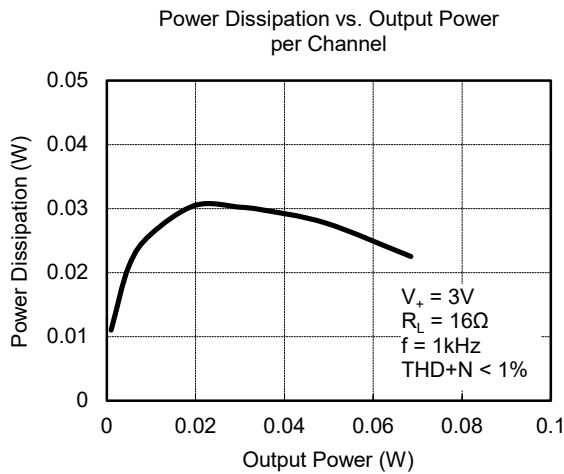
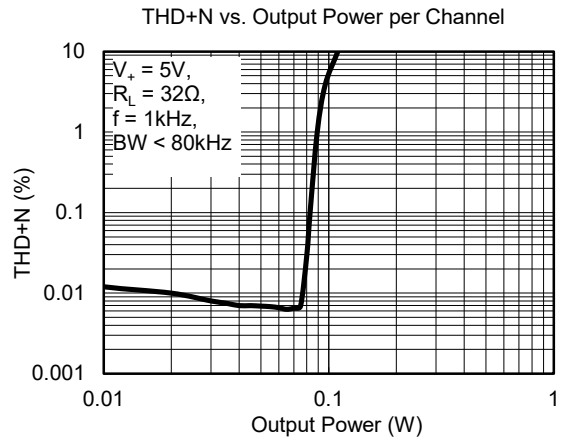
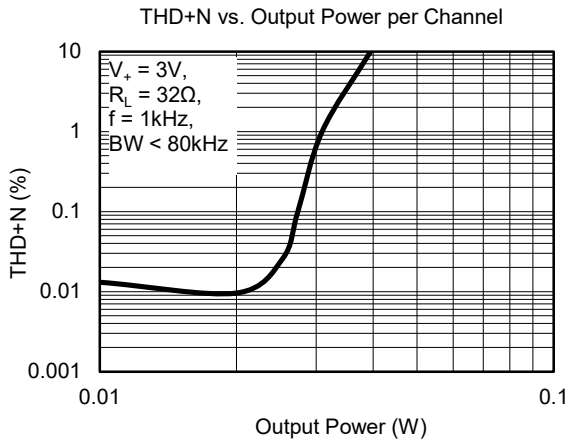

TYPICAL PERFORMANCE CHARACTERISTICS (continued)

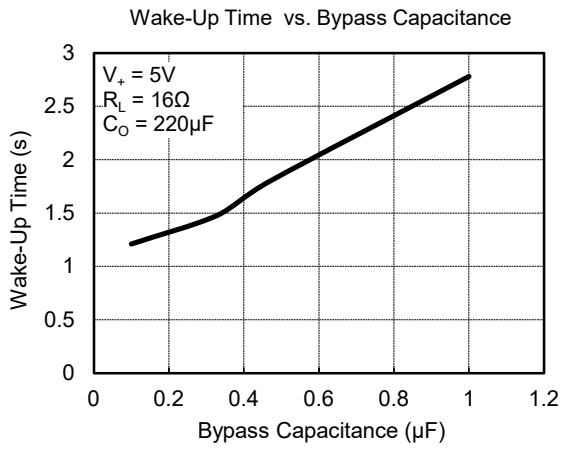
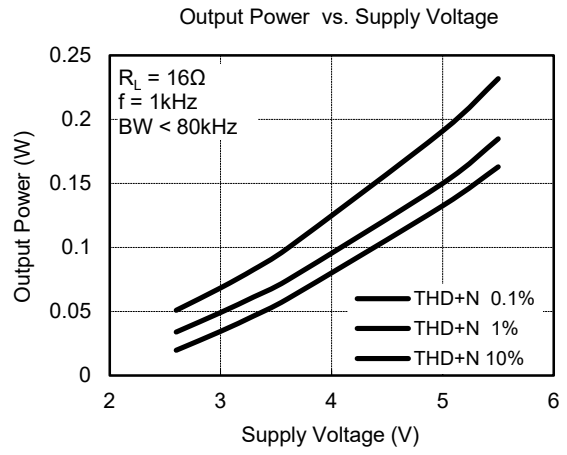
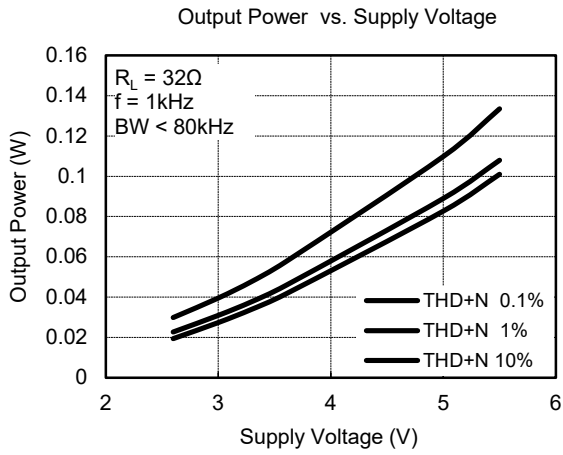

REVISION HISTORY

NOTE: Page numbers for previous revisions may differ from page numbers in the current version.

MARCH 2017 – REV.A.3 to REV.A.4

Changed Packing Option 2

NOVEMBER 2012 – REV.A.2 to REV.A.3

Added note for Typical Application circuit 8

MAY 2012 – REV.A.1 to REV.A.2

Added Tape and Reel Information 10-11

AUGUST 2010 – REV.A to REV.A.1

Updated Electrical Characteristics 3

Changes from Original (JUNE 2008) to REV.A

Changed from product preview to production data All

PACKAGE OUTLINE DIMENSIONS

MSOP-10

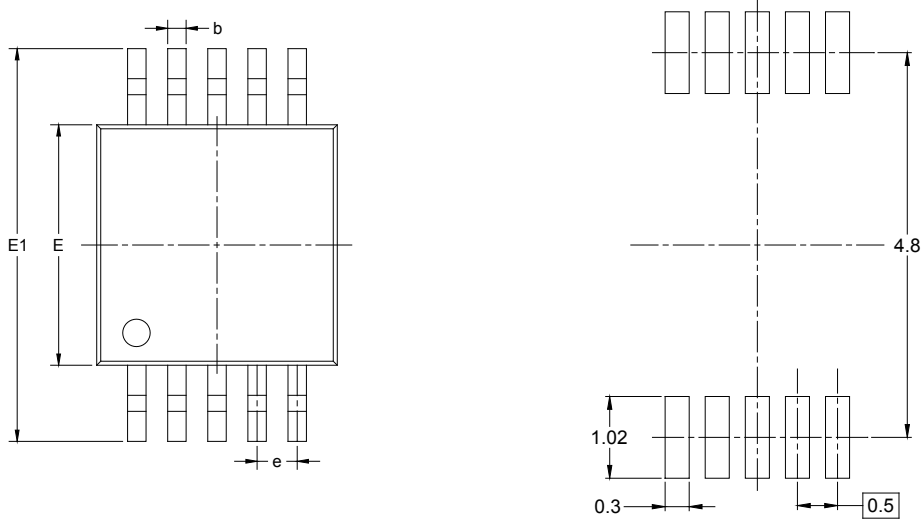

RECOMMENDED LAND PATTERN (Unit: mm)

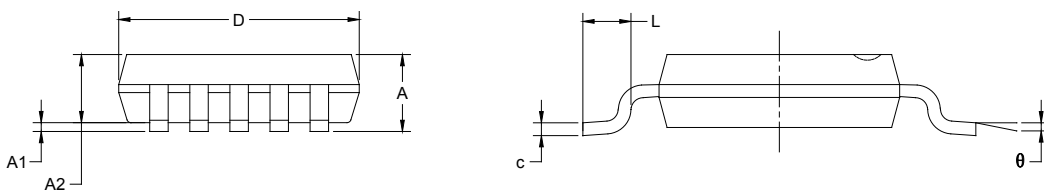

Symbol	Dimensions In Millimeters		Dimensions In Inches	
	MIN	MAX	MIN	MAX
A	0.820	1.100	0.032	0.043
A1	0.020	0.150	0.001	0.006
A2	0.750	0.950	0.030	0.037
b	0.180	0.280	0.007	0.011
c	0.090	0.230	0.004	0.009
D	2.900	3.100	0.114	0.122
E	2.900	3.100	0.114	0.122
E1	4.750	5.050	0.187	0.199
e	0.500 BSC		0.020 BSC	
L	0.400	0.800	0.016	0.031
θ	0°	6°	0°	6°

PACKAGE INFORMATION

TAPE AND REEL INFORMATION

REEL DIMENSIONS

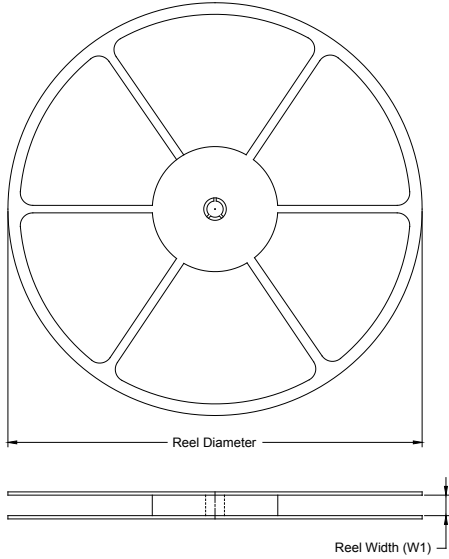

TAPE DIMENSIONS

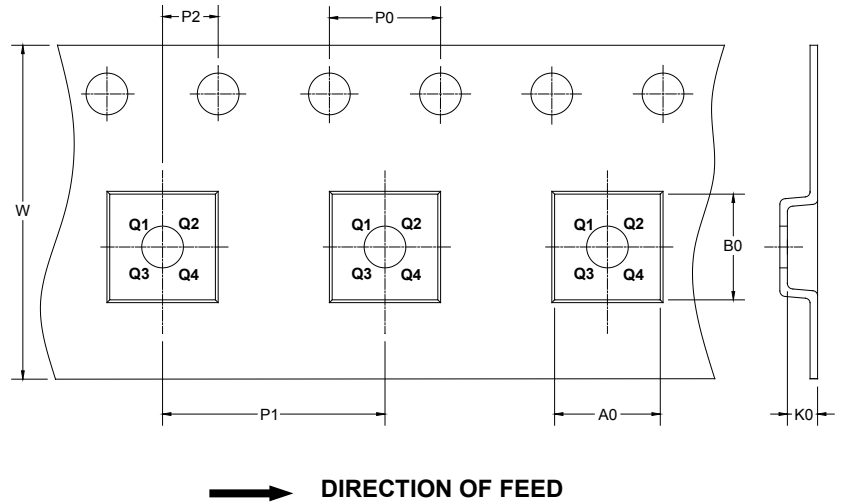

NOTE: The picture is only for reference. Please make the object as the standard.

KEY PARAMETER LIST OF TAPE AND REEL

Package Type	Reel Diameter	Reel Width W1 (mm)	A0 (mm)	B0 (mm)	K0 (mm)	P0 (mm)	P1 (mm)	P2 (mm)	W (mm)	Pin1 Quadrant
MSOP-10	13"	12.4	5.20	3.30	1.20	4.0	8.0	2.0	12.0	Q1

000001

PACKAGE INFORMATION

CARTON BOX DIMENSIONS



NOTE: The picture is only for reference. Please make the object as the standard.

KEY PARAMETER LIST OF CARTON BOX

Reel Type	Length (mm)	Width (mm)	Height (mm)	Pizza/Carton
13"	386	280	370	5

DD0002

单击下面可查看定价，库存，交付和生命周期等信息

[>>SGMICRO\(圣邦微电子\)](#)