

Surface Mount Schottky Barrier Rectifier
Reverse Voltage - 30 to 60V
Forward Current - 2.0A

Features

- Metal silicon junction, majority carrier conduction
- For surface mounted applications
- Low power loss, high efficiency
- High forward surge current capability
- For use in low voltage, high frequency inverters, free wheeling, and polarity protection applications

MECHANICAL DATA

- Case: SOD-123FL
- Terminals: Solderable per MIL-STD-750, Method 2026
- Approx. Weight: 15mg 0.00048oz

Absolute Maximum Ratings and Electrical characteristics

Ratings at 25 °C ambient temperature unless otherwise specified. Single phase, half wave, 60Hz resistive or inductive load, for capacitive load, derate by 20 %

PINNING

PIN	DESCRIPTION
1	Cathode
2	Anode

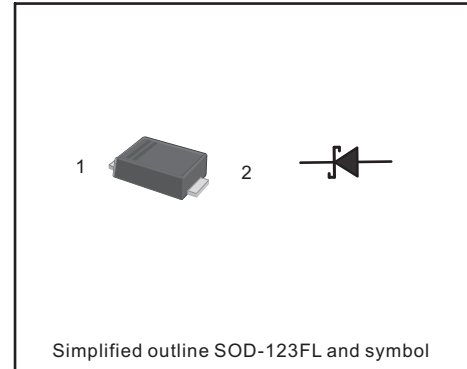

Parameter	Symbols	RB060M-30	RB060M-40	RB060M-60	Units
Maximum Repetitive Peak Reverse Voltage	V_{RRM}	30	40	60	V
Maximum RMS voltage	V_{RMS}	28	28	42	V
Maximum DC Blocking Voltage	V_{DC}	30	40	60	V
Maximum Average Forward Rectified Current	$I_{F(AV)}$	2.0			A
Peak Forward Surge Current, 8.3ms Single Half Sine-wave Superimposed on Rated Load (JEDEC method)	I_{FSM}	50			A
Max Instantaneous Forward Voltage at 2A	V_F	0.55		0.70	V
Maximum DC Reverse Current $T_a = 25^\circ\text{C}$ at Rated DC Reverse Voltage $T_a = 100^\circ\text{C}$	I_R	0.5 5			mA
Typical Junction Capacitance ¹⁾	C_j	220	80		pF
Typical Thermal Resistance ²⁾	$R_{\theta JA}$	80			$^\circ\text{C/W}$
Operating Junction Temperature Range	T_j	-55 ~ +125			$^\circ\text{C}$
Storage Temperature Range	T_{stg}	-55 ~ +150			$^\circ\text{C}$

1) Measured at 1MHz and applied reverse voltage of 4 V D.C.

2) P.C.B. mounted with 0.2 X 0.2" (5 X 5 mm) copper pad areas.

Fig.1 Forward Current Derating Curve

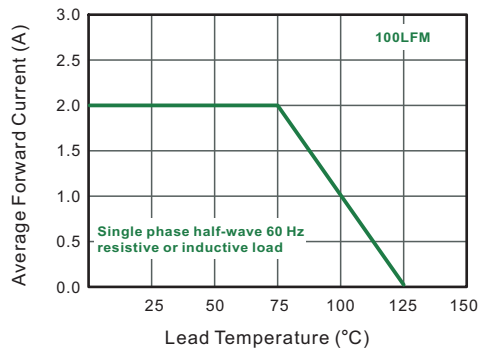

Fig.2 Typical Reverse Characteristics

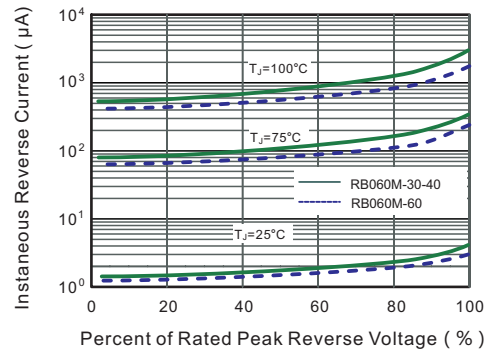

Fig.3 Typical Forward Characteristic

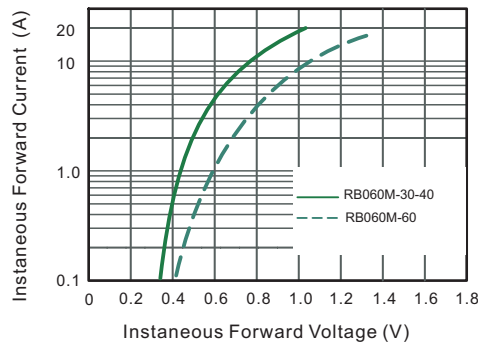

Fig.4 Typical Junction Capacitance

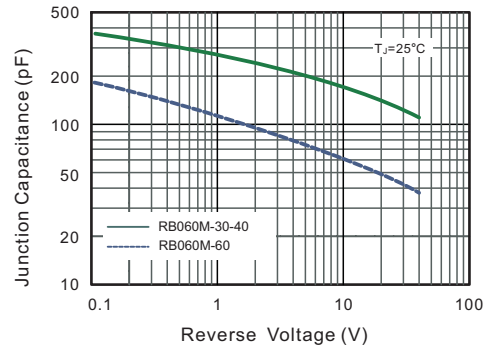

Fig.5 Maximum Non-Repetitive Peak Forward Surge Current

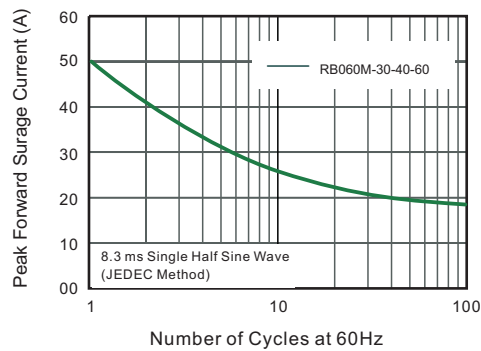
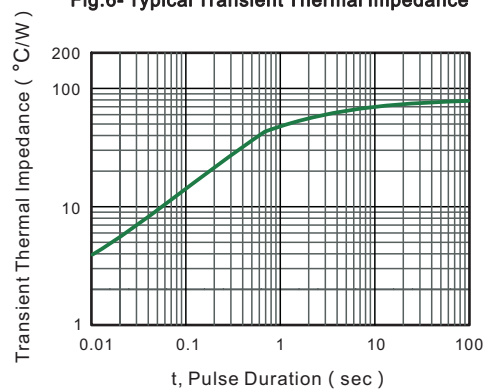

Fig.6- Typical Transient Thermal Impedance



PACKAGE OUTLINE

Plastic surface mounted package; 2 leads

SOD-123FL

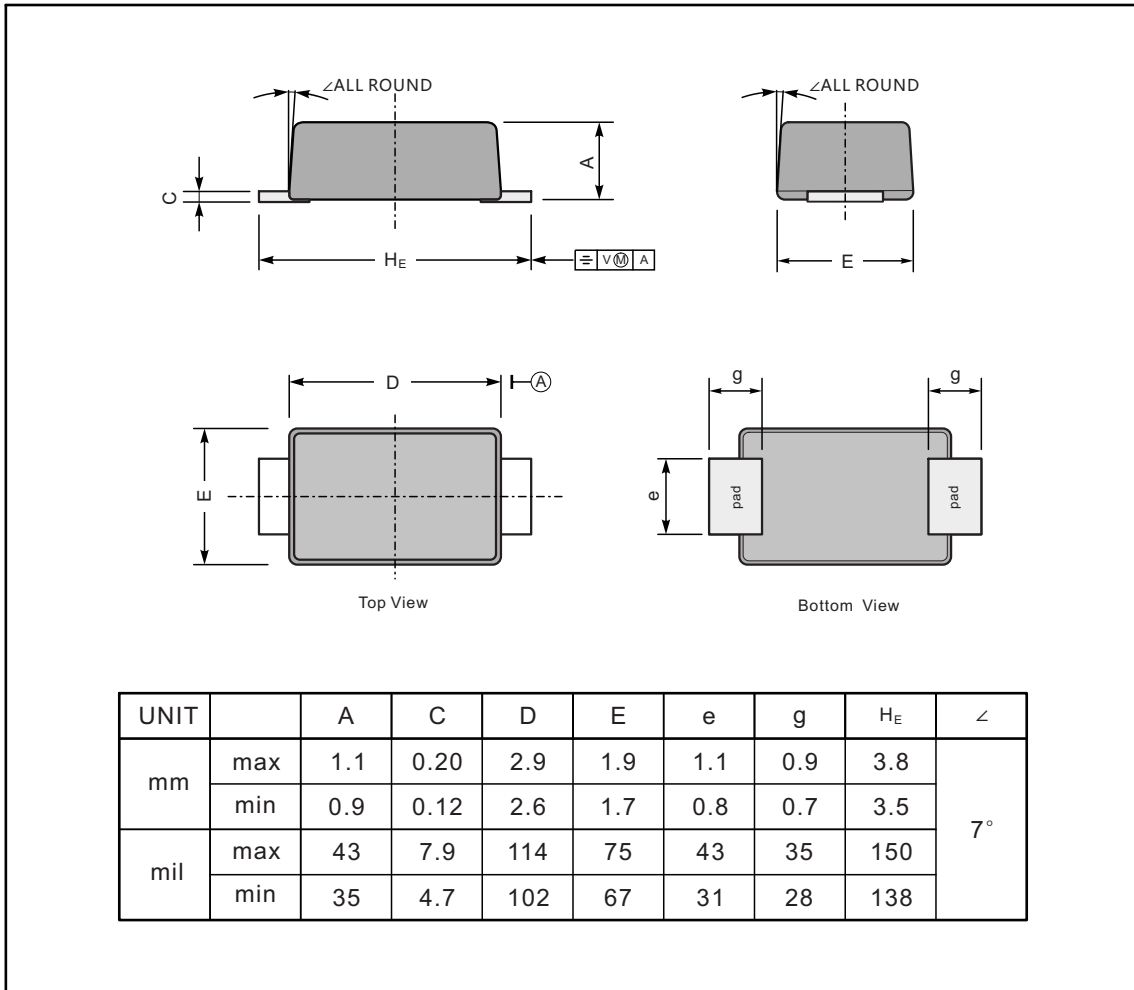

The recommended mounting pad size

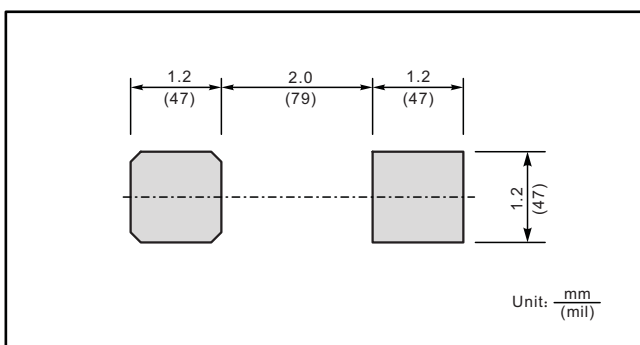

单击下面可查看定价，库存，交付和生命周期等信息

[>>SHIKUES\(时科\)](#)