

1.2A SURFACE MOUNT GLASS PASSIVATED BRIDGE RECTIFIER

FEATURES:

- Glass Passivated Chip Junction
- Reverse Voltage - 100 to 1000 V
- Forward Current - 1.2A
- High Surge Current Capability
- Designed for Surface Mount Application

MECHANICAL DATA

- Case: ABS/LBF
- Terminals: Solderable per MIL-STD-750, Method 2026
- Approx. Weight: 88mg / 0.0031oz

PINNING

PIN	DESCRIPTION
1	Input Pin (~)
2	Input Pin (~)
3	Output Anode (+)
4	Output Cathode (-)

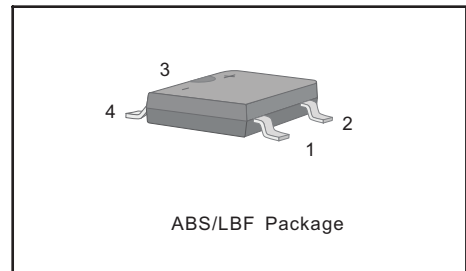

Maximum Ratings and Electrical characteristics

Ratings at 25 °C ambient temperature unless otherwise specified. Single phase half-wave 60 Hz, resistive or inductive load , for capacitive load current derate by 20 %.

Parameter	Symbols	ABS1K	ABS2K	ABS4K	ABS6K	ABS8K	ABS10K	Units
Maximum Repetitive Peak Reverse Voltage	V_{RRM}	100	200	400	600	800	1000	V
Maximum RMS voltage	V_{RMS}	70	140	280	420	560	700	V
Maximum DC Blocking Voltage	V_{DC}	100	200	400	600	800	1000	V
Average Rectified Output Current at $T_c = 125\text{ }^\circ\text{C}$	I_o	1.2						A
Peak Forward Surge Current 8.3 ms Single Half Sine Wave Superimposed on Rated Load (JEDEC Method)	I_{FSM}	40						A
Forward Voltage per element @ $I_F = 1.2\text{A}$	V_F	1.1						V
Maximum DC Reverse Current at Rated DC Blocking Voltage @ $T_A = 25\text{ }^\circ\text{C}$ @ $T_A = 125\text{ }^\circ\text{C}$	I_R	5 100						μA
Typical Junction Capacitance (Note1)	C_j	18						pF
Typical Thermal Resistance (Note2)	$R_{\theta JA}$ $R_{\theta JC}$	70 18						$^\circ\text{C/W}$
Operating and Storage Temperature Range	T_j, T_{stg}	-55 ~ +150						$^\circ\text{C}$

Note: 1. Measured at 1MHz and applied reverse voltage of 4 V D.C.

2. Mounted on glass epoxy PC board with 4×1.5"×1.5" (3.81×3.81 cm) copper pad.

Fig.1 Average Rectified Output Current Derating Curve

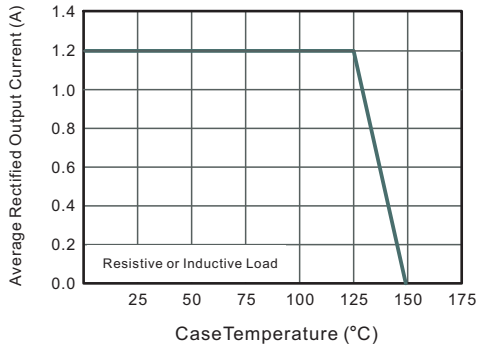

Fig.2 Typical Reverse Characteristics

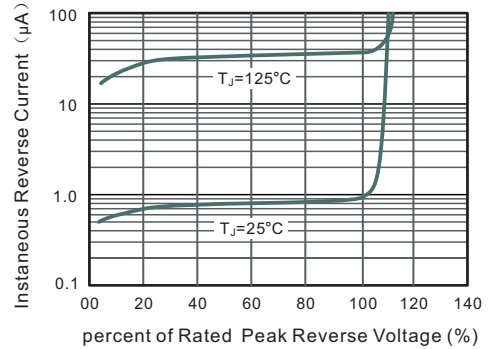

Fig.3 Typical Instantaneous Forward Characteristics

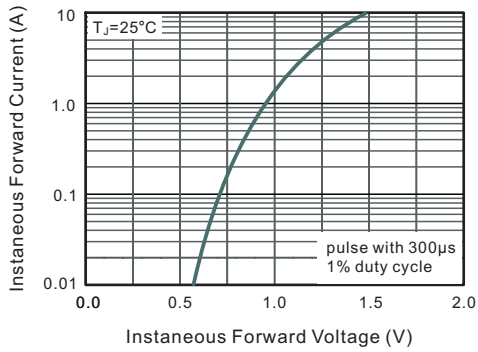

Fig.4 Typical Junction Capacitance

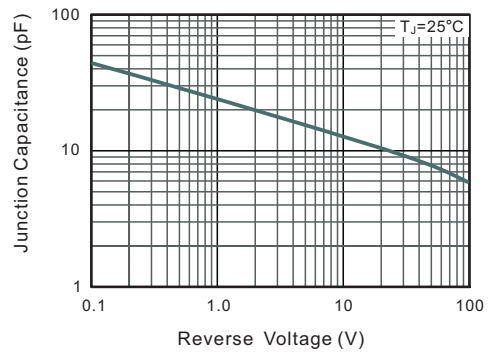
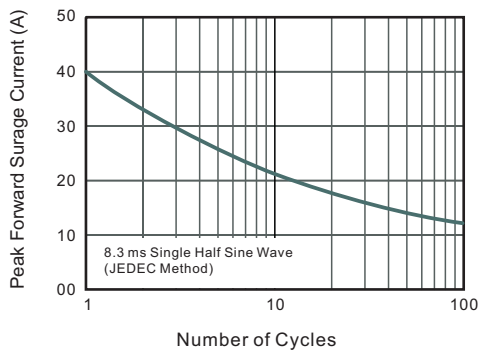

Fig.5 Maximum Non-Repetitive Peak Forward Surge Current



PACKAGE OUTLINE

Plastic surface mounted package; 4 leads

ABS/LBF

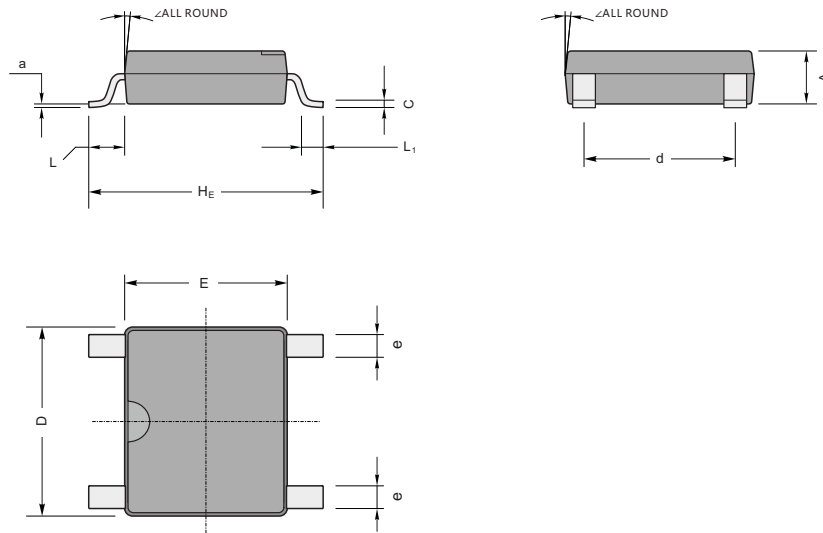

ABS/LBF mechanical data

UNIT		A	C	D	E	H_E	d	e	L	L_1	a	\angle
mm	max	1.5	0.22	5.2	4.5	6.4	4.2	0.7	0.95	0.6	0.2	7°
	min	1.3	0.15	4.9	4.2	6.0	3.8	0.5				
mil	max	59	8.7	205	177	252	165	28	37	24	8	
	min	51	5.9	193	166	236	150	20				

The recommended mounting pad size

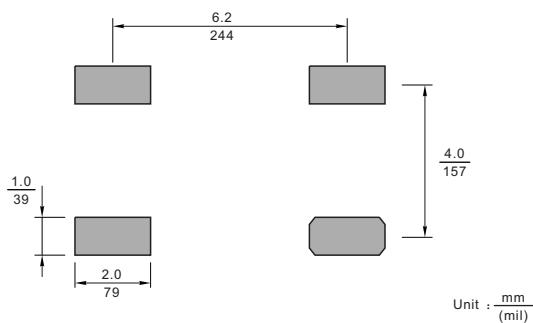

Marking

Type number	Marking code
ABS1K	12T1
ABS2K	12T2
ABS4K	12T4
ABS6K	12T6
ABS8K	12T8
ABS10K	12T10

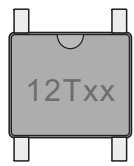

12Txx

单击下面可查看定价，库存，交付和生命周期等信息

[>>SHIKUES\(时科\)](#)