

SCHOTTKY BARRIER RECTIFIERS

FEATURES

- Low Forward Voltage Drop
- Guard Ring Construction for Transient Protection
- High Conductance
- Also Available in Lead Free Version

MECHANICAL DATA

- Case: SOD-123
- Terminals: Solderable per MIL-STD-750, Method 2026
- Approx. Weight: 16mg 0.00056oz

Maximum Ratings and Electrical characteristics

Ratings at 25 °C ambient temperature unless otherwise specified.

PINNING

PIN	DESCRIPTION
1	Cathode
2	Anode

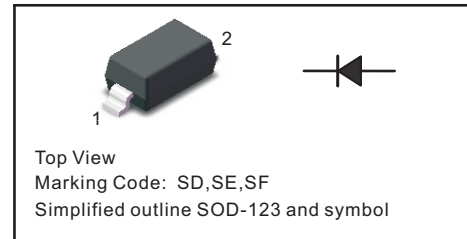

Parameter	Symbols	B0520W	B0530W	B0540W	Units	
Peak Repetitive Reverse Voltage	V_{RRM}	20	30	40	V	
RMS reverse voltage reverse voltage (DC)	V_{RMS}	14	21	28	V	
Maximum DC Blocking Voltage	V_{DC}	20	30	40	V	
Maximum Average Forward Current at Ta=25°C	I_O	0.5			A	
Peak Forward Surge Current, 8.3ms single half sine-wave superimposed on rated load (JEDEC method)	I_{FSM}	5.5			A	
Maximum Instantaneous Forward Voltage	V_F	IF=0.1A	0.330	0.375	—	V
		IF=0.5A	0.390	0.430	0.510	
		IF=1A	—	—	0.620	
Reverse current	I_R	VR=10V	75	—	—	uA
		VR=15V	—	20	—	
		VR=20V	250	—	10	
		VR=30V	—	130	—	
		VR=40V	—	—	20	
Thermal Resistance, Junction to Ambient Air	$R_{\theta JA}$	200			°C/W	
Junction temperature	T_j	-55 ~ +125			V	
Storage temperature	T_{stg}	-55 ~ +150			V	

Fig.1 Forward Current Derating Curve

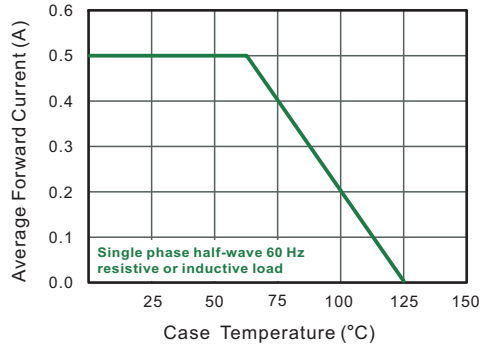

Fig.2 Typical Reverse Characteristics

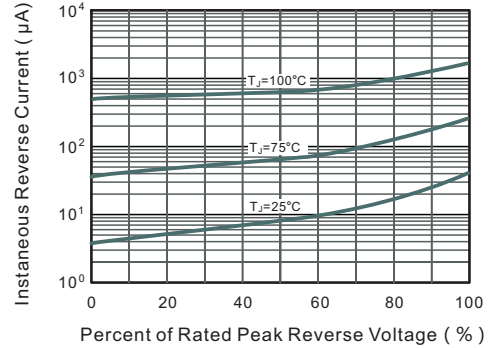

Fig.3 TYPICAL FORWARD VOLTAGE

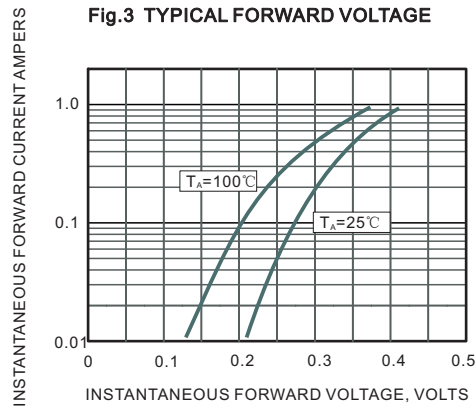

Fig.4 Typical Junction Capacitance

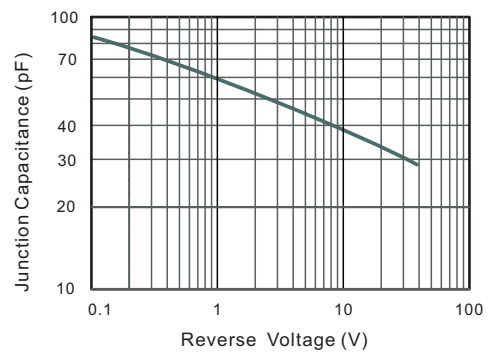
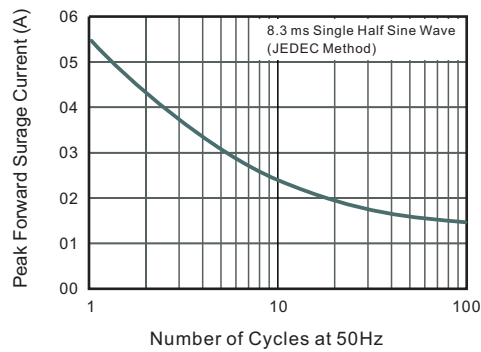

Fig.5 Maximum Non-Repetitive Peak Forward Surge Current



PACKAGE OUTLINE

Plastic surface mounted package; 2 leads

SOD-123

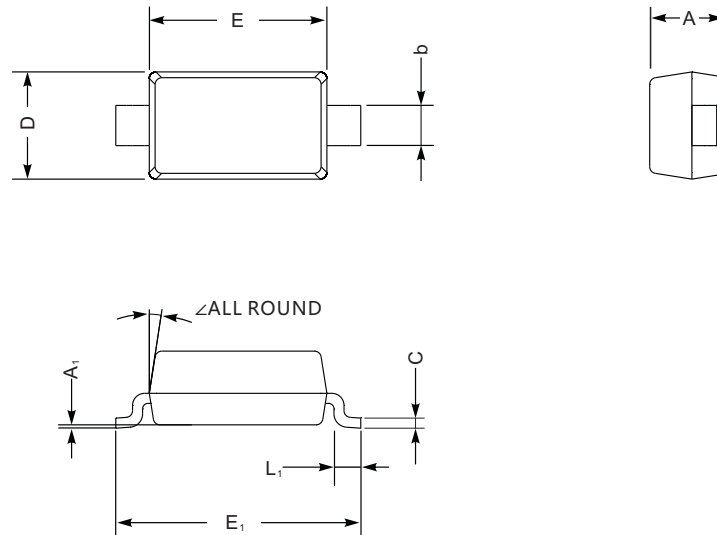

SOD-123 mechanical data

UNIT		A	C	D	E	E ₁	L ₁	b	A ₁	∠
mm	max	1.3	0.22	1.8	2.8	3.9	0.45	0.7	0.2	9°
	min	0.9	0.09	1.5	2.5	3.6	0.25	0.5	—	
mil	max	51	8.7	71	110	154	18	28	8	
	min	35	3.5	59	98	142	10	20	—	

The recommended mounting pad size

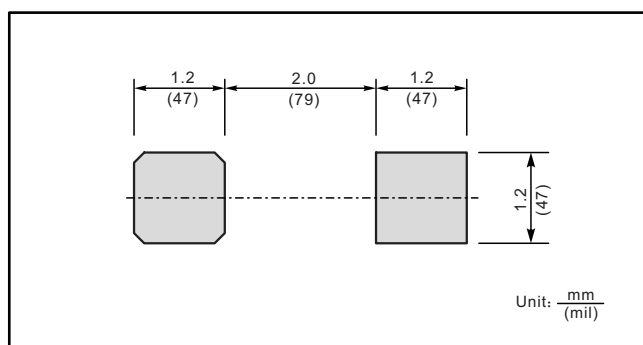

Marking

Type number	Marking code
B0520W	SD
B0530W	SE
B0540W	SF

单击下面可查看定价，库存，交付和生命周期等信息

[>>SHIKUES\(时科\)](#)