

FEATURES

- For surface mounted applications
- Glass Passivated Chip Junction
- Fast reverse recovery time
- Ideal for automated placement
- Lead free in comply with EU RoHS 2011/65/EU directives

MECHANICAL DATA

- Case: SOD-323
- Terminals: Solderable per MIL-STD-750, Method 2026
- Approx. Weight: 5.48mg / 0.00019oz

PINNING

PIN	DESCRIPTION
1	Cathode
2	Anode

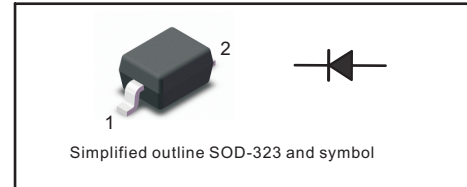

Absolute Maximum Ratings at 25 °C

Parameter	Symbols	BAS316	Units
Maximum Repetitive Peak Reverse Voltage	V_{RRM}	100	V
Maximum RMS voltage	V_{RMS}	75	V
Continuous Forward Current	I_F	300	mA
Non-repetitive Peak Forward Surge Current at 1ms	I_{FSM}	4	A
Total Power Dissipation	P_{tot}	400	mW
Operating and Storage Temperature Range	T_j, T_{stg}	-55 ~ +150	°C

Characteristics at $T_a = 25\text{ °C}$

Parameter	Symbols	BAS316	Units
Reverse Breakdown Voltage at $I_R = 1\text{ }\mu\text{A}$	$V_{(BR)R}$	75	V
Maximum Forward Voltage at 150 mA	V_F	1.1	V
Peak Reverse Current at $V_R = 75\text{V}$ $T_j = 25\text{°C}$ at $V_R = 75\text{V}$ $T_j = 150\text{°C}$	I_R	1 50	μA
Typical Junction Capacitance	C_j	5	pF
Maximum Reverse Recovery Time ⁽¹⁾	t_{rr} Typical	6	ns

(1) Measured with $I_F = 0.5\text{ A}$, $I_R = 1\text{ A}$, $I_{rr} = 0.25\text{ A}$

Fig.1 Forward Current Derating Curve

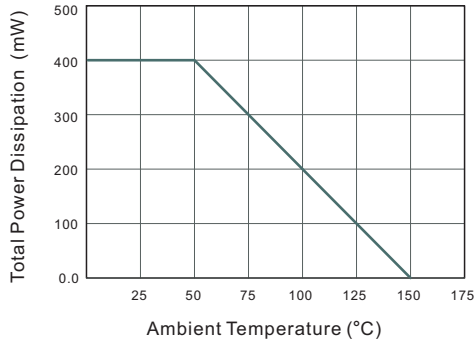

Fig.2 Typical Reverse Characteristics

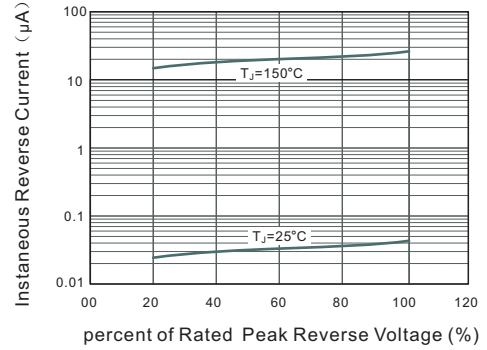

Fig.3 Typical Instantaneous Forward Characteristics

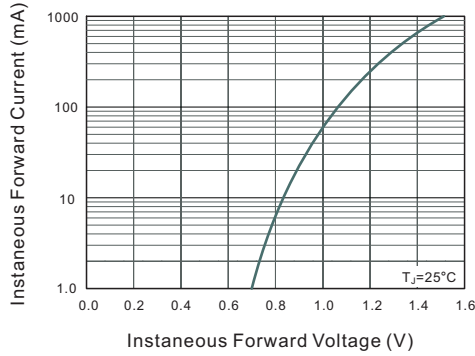
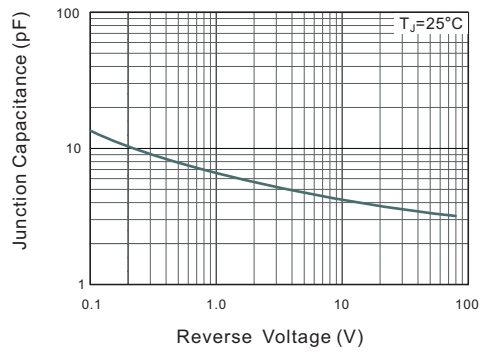

Fig.4 Typical Junction Capacitance



PACKAGE OUTLINE

Plastic surface mounted package; 2 leads

SOD-323

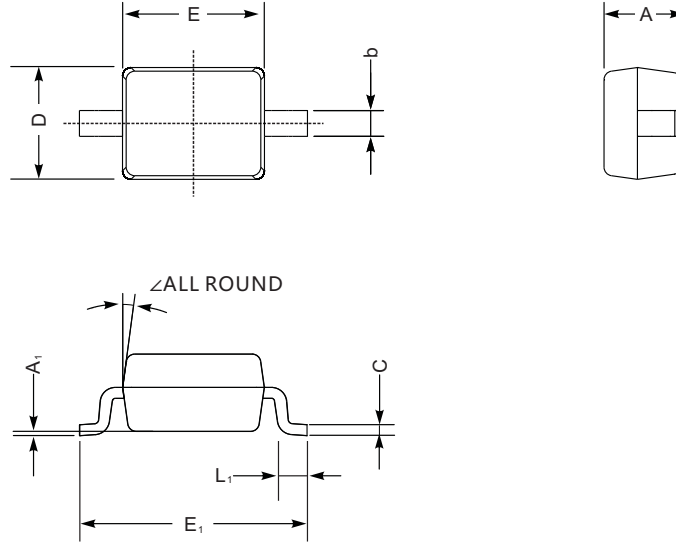

SOD-323 mechanical data

UNIT		A	C	D	E	E ₁	b	L ₁	A ₁	∠
mm	max	1.1	0.15	1.4	1.8	2.75	0.4	0.45	0.2	9°
	min	0.8	0.08	1.2	1.4	2.55	0.25	0.2	—	
mil	max	43	5.9	55	70	108	16	16	8	
	min	32	3.1	47	63	100	9.8	7.9	—	

The recommended mounting pad size

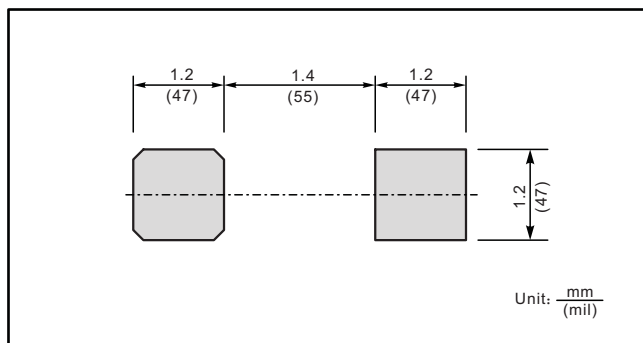

Marking

Type number	Marking code
BAS316	A6

单击下面可查看定价，库存，交付和生命周期等信息

[>>SHIKUES\(时科\)](#)