

## SILICON EPITAXIAL PLANAR SCHOTTKY BARRIER DIODE

for low current rectification and high speed switching applications

### Features

- Extremely small surface mounting type

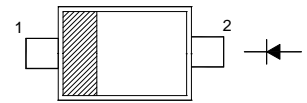

Top View

PIN	DESCRIPTION
1	Cathode
2	Anode

### Absolute Maximum Ratings ( $T_a = 25\text{ }^\circ\text{C}$ )

Parameter	Symbol	Value	Unit
Reverse Voltage	$V_R$	30	V
Mean Rectifying Current	$I_O$	200	mA
Peak Forward Surge Current (60Hz for Cyc.)	$I_{FSM}$	1	A
Junction Temperature	$T_j$	125	$^\circ\text{C}$
Storage Temperature Range	$T_{stg}$	- 40 to + 125	$^\circ\text{C}$

### Characteristics at $T_a = 25\text{ }^\circ\text{C}$

Parameter	Symbol	Max.	Unit
Forward Voltage at $I_F = 200\text{ mA}$	$V_F$	0.5	V
Reverse Current at $V_R = 10\text{ V}$	$I_R$	30	$\mu\text{A}$

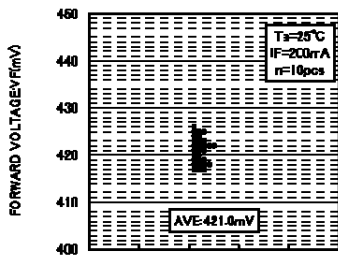
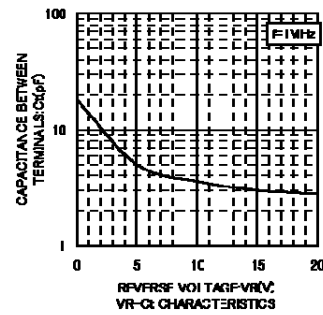
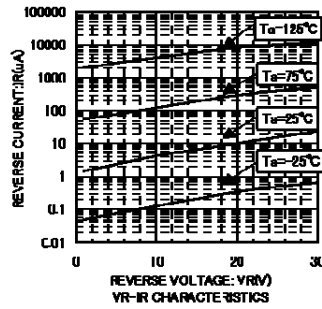
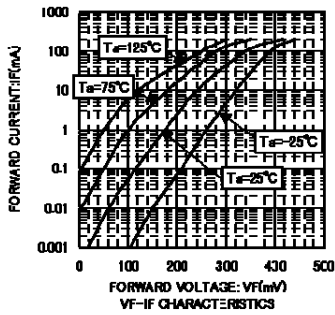

VF DISPERSION MAP

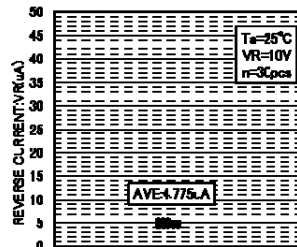

IR DISPERSION MAP

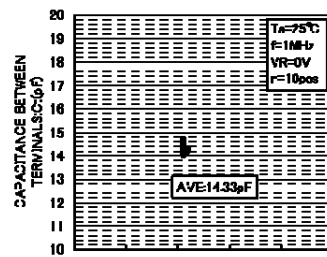

C<sub>t</sub> DISPERSION MAP

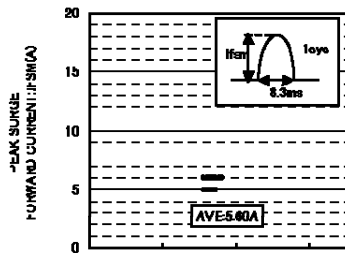

IFSM DISPERSION MAP

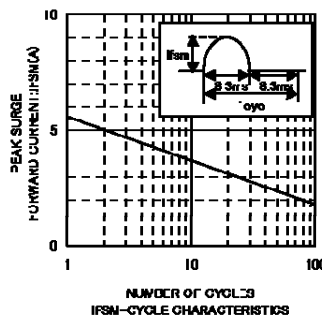

IFSM-CYCLE CHARACTERISTICS

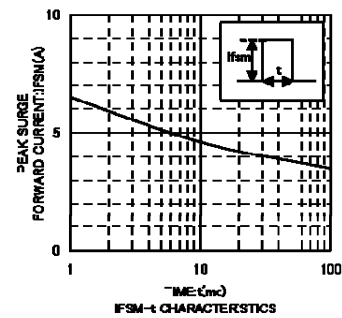

IFSM-t CHARACTERISTICS

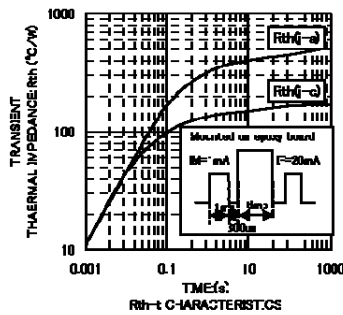

R<sub>th</sub>-t CHARACTERISTICS

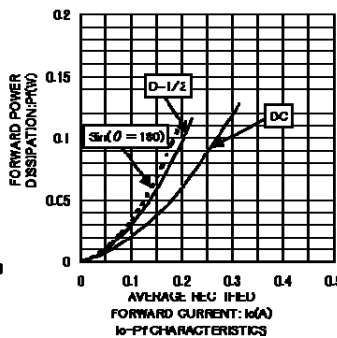

I<sub>o</sub>-P<sub>F</sub> CHARACTERISTICS

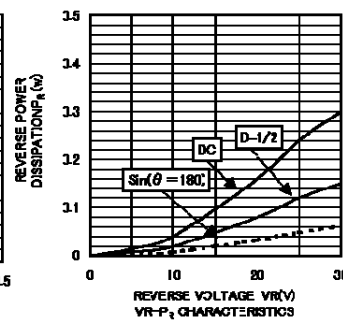

VR-P<sub>R</sub> CHARACTERISTICS

## PACKAGE OUTLINE

Plastic surface mounted package; 2 leads

SOD-523

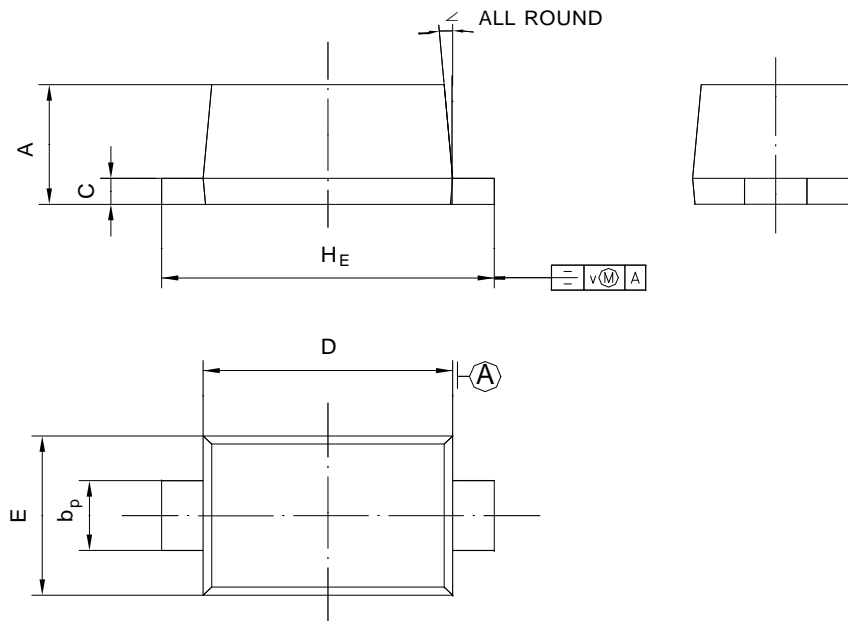

UNIT	A	b <sub>p</sub>	C	D	E	H <sub>E</sub>	V	∠
mm	0.70 0.60	0.4 0.3	0.135 0.100	1.25 1.15	0.85 0.75	1.7 1.5	0.1	5°

单击下面可查看定价，库存，交付和生命周期等信息

[>>SHIKUES\(时科\)](#)