

NPN Silicon Epitaxial Planar Transistor

for switching and amplifier applications.
Especially suitable for AF-driver stages
and low power output stages.

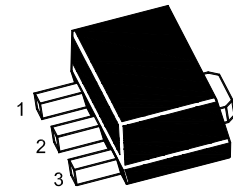

1.Base 2.Collector 3.Emitter
SOT-89 Plastic Package

Absolute Maximum Ratings ($T_a = 25\text{ }^\circ\text{C}$)

Parameter	Symbol	Value	Unit
Collector Base Voltage	V_{CBO}	40	V
Collector Emitter Voltage	V_{CEO}	25	V
Emitter Base Voltage	V_{EBO}	6	V
Collector Current	I_C	1.5	A
Power Dissipation	P_{tot}	625	mW
Junction Temperature	T_j	150	$^\circ\text{C}$
Storage Temperature Range	T_{Stg}	- 55 to + 150	$^\circ\text{C}$

Characteristics at $T_a = 25\text{ }^\circ\text{C}$

Parameter	Symbol	Min.	Typ.	Max.	Unit
DC Current Gain at $V_{CE} = 1\text{ V}$, $I_C = 5\text{ mA}$ at $V_{CE} = 1\text{ V}$, $I_C = 100\text{ mA}$ at $V_{CE} = 1\text{ V}$, $I_C = 800\text{ mA}$ Current Gain Group C D	h_{FE}	45	-	-	-
	h_{FE}	120	-	200	-
	h_{FE}	160	-	300	-
	h_{FE}	40	-	-	-
	Collector Base Cutoff Current at $V_{CB} = 35\text{ V}$	I_{CBO}	-	-	100
Emitter Base Cutoff Current at $V_{EB} = 6\text{ V}$	I_{EBO}	-	-	100	nA
Collector Base Breakdown Voltage at $I_C = 100\text{ }\mu\text{A}$	$V_{(BR)CBO}$	40	-	-	V
Collector Emitter Breakdown Voltage at $I_C = 2\text{ mA}$	$V_{(BR)CEO}$	25	-	-	V
Emitter Base Breakdown Voltage at $I_E = 100\text{ }\mu\text{A}$	$V_{(BR)EBO}$	6	-	-	V
Collector Emitter Saturation Voltage at $I_C = 800\text{ mA}$, $I_B = 80\text{ mA}$	$V_{CE(sat)}$	-	-	0.5	V
Base Emitter Saturation Voltage at $I_C = 800\text{ mA}$, $I_B = 80\text{ mA}$	$V_{BE(sat)}$	-	-	1.2	V
Base Emitter Voltage at $I_C = 10\text{ mA}$, $V_{CE} = 1\text{ V}$	V_{BE}	-	-	1	V
Gain Bandwidth Product at $V_{CE} = 10\text{ V}$, $I_C = 50\text{ mA}$	f_T	100	-	-	MHz
Collector Base Capacitance at $V_{CB} = 10\text{ V}$, $f = 1\text{ MHz}$	C_{OB}	-	9	-	pF

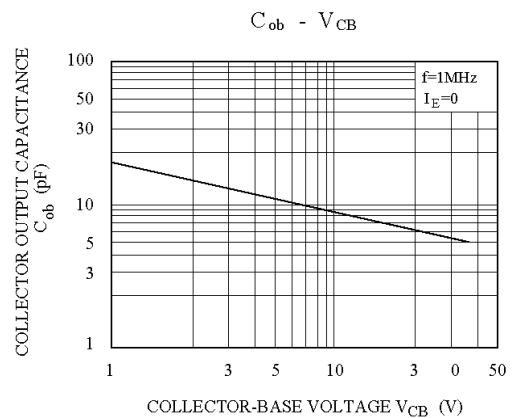
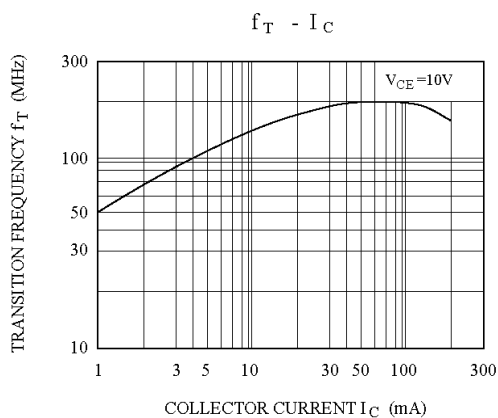
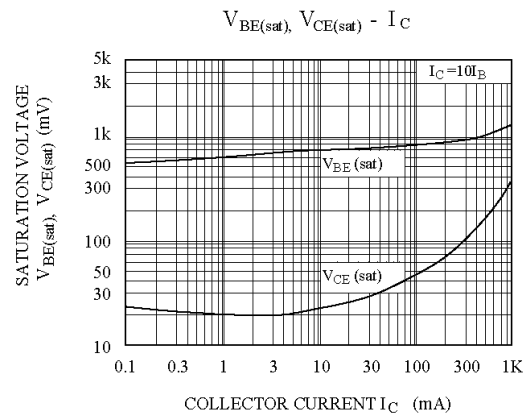
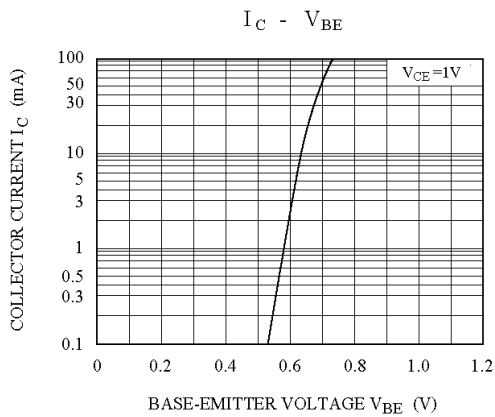
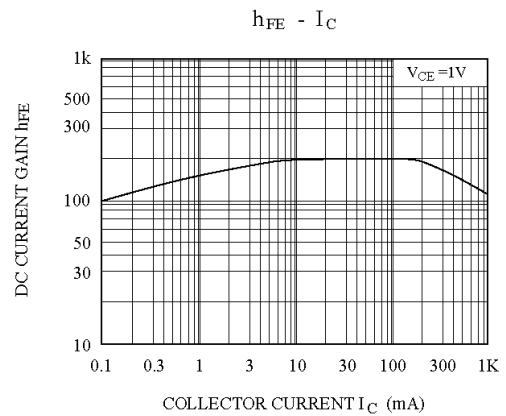
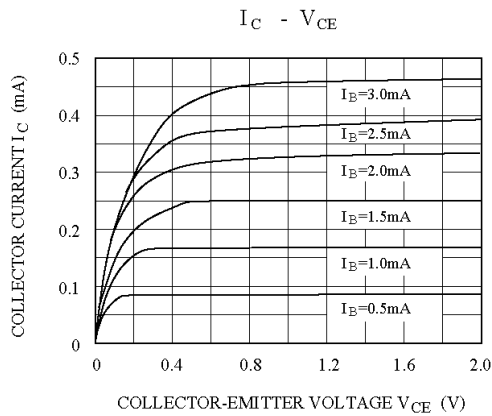

SOT-89 PACKAGE OUTLINE

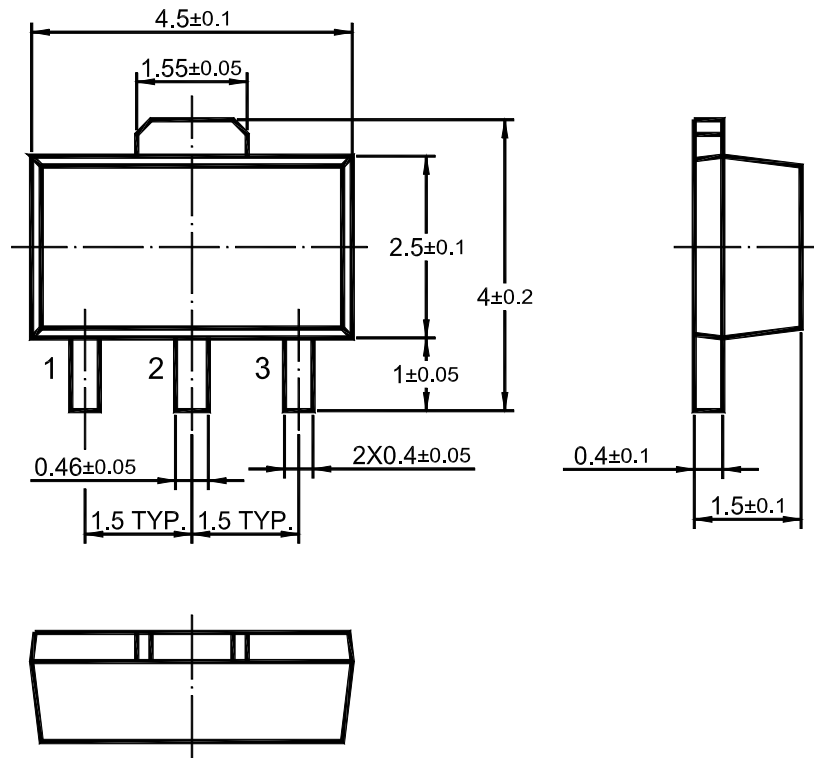

Dimensions in mm

单击下面可查看定价，库存，交付和生命周期等信息

[>>SHIKUES\(时科\)](#)