

P-Channel Enhancement Mode MOSFET

Feature

- 30V/-3.2A, $R_{DS(ON)} = 55\text{m}\Omega(\text{MAX})$ @ $V_{GS} = -10\text{V}$.
- $R_{DS(ON)} = 70\text{m}\Omega(\text{MAX})$ @ $V_{GS} = -4.5\text{V}$.
- $R_{DS(ON)} = 120\text{m}\Omega(\text{MAX})$ @ $V_{GS} = -2.5\text{V}$.

Super High dense cell design for extremely low $R_{DS(ON)}$

Reliable and Rugged

SOT-23 for Surface Mount Package



SOT-23

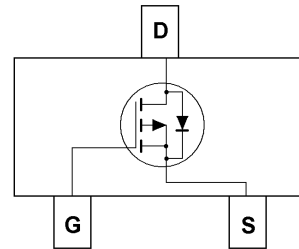

Applications

- Power Management
- Portable Equipment and Battery Powered Systems.

Absolute Maximum Ratings

$T_A = 25^\circ\text{C}$ Unless Otherwise noted

Parameter	Symbol	Limit	Units
Drain-Source Voltage	V_{DS}	-30	V
Gate-Source Voltage	V_{GS}	± 12	V
Drain Current-Continuous	I_D	-3.2	A

Electrical Characteristics

$T_A = 25^\circ\text{C}$ Unless Otherwise noted

Parameter	Symbol	Test Conditions	Min	Typ.	Max	Units
Off Characteristics						
Drain to Source Breakdown Voltage	BVDSS	$V_{GS} = 0\text{V}, I_D = -250\mu\text{A}$	-30	-	-	V
Zero-Gate Voltage Drain Current	IDSS	$V_{DS} = -24\text{V}, V_{GS} = 0\text{V}$	-	-	-1	μA
Gate Body Leakage Current, Forward	IGSSF	$V_{GS} = 12\text{V}, V_{DS} = 0\text{V}$	-	-	100	nA
Gate Body Leakage Current, Reverse	IGSSR	$V_{GS} = -12\text{V}, V_{DS} = 0\text{V}$	-	-	-100	nA
On Characteristics						
Gate Threshold Voltage	$V_{GS(th)}$	$V_{GS} = V_{DS}, I_D = -250\mu\text{A}$	-0.7	-	-1.3	V
Static Drain-source On-Resistance	RDS(ON)	$V_{GS} = -10\text{V}, I_D = -3.2\text{A}$	-	50	55	$\text{m}\Omega$
		$V_{GS} = -4.5\text{V}, I_D = -3.0\text{A}$	-	60	70	$\text{m}\Omega$
		$V_{GS} = -2.5\text{V}, I_D = -1.0\text{A}$	-	80	120	$\text{m}\Omega$
Drain-Source Diode Characteristics and Maximum Ratings						
Drain-Source Diode Forward Voltage	VSD	$V_{GS} = 0\text{V}, I_S = -1.0\text{A}$			-1.0	V

Typical Characteristics

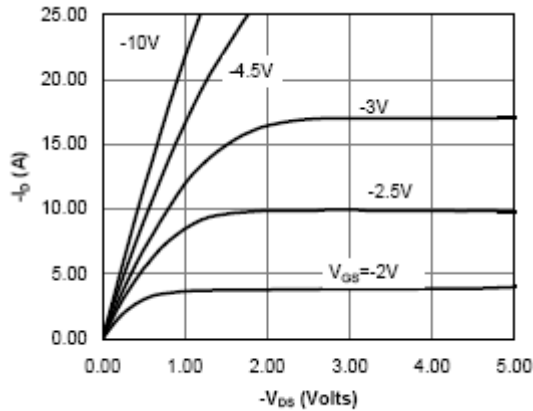

Fig 1: On-Region Characteristics

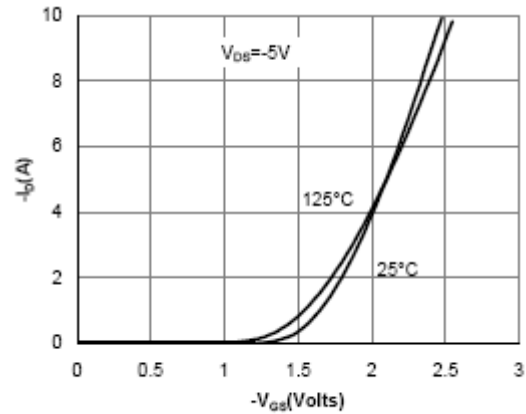

Figure 2: Transfer Characteristics

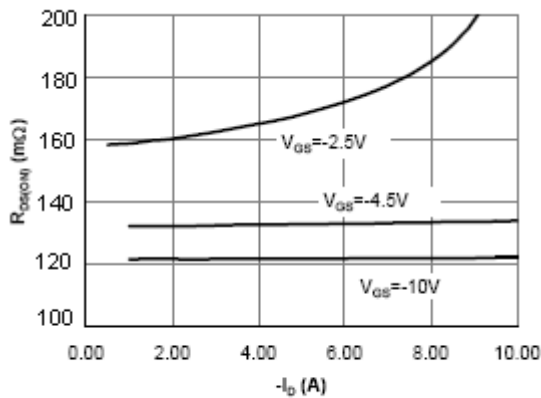

Figure 3: On-Resistance vs. Drain Current and Gate Voltage

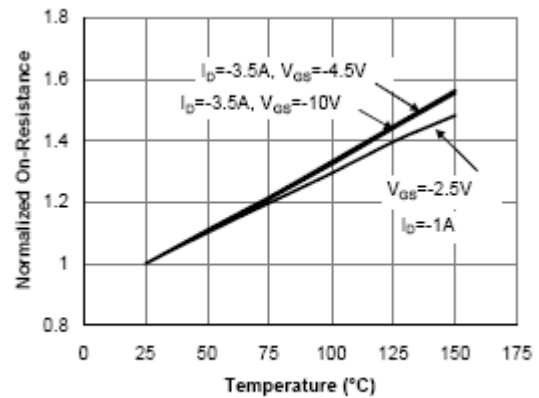

Figure 4: On-Resistance vs. Junction Temperature

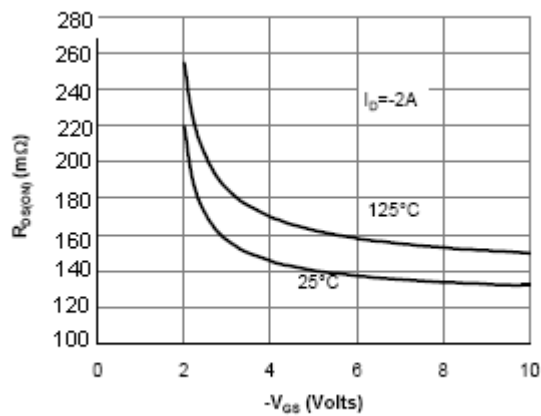

Figure 5: On-Resistance vs. Gate-Source Voltage

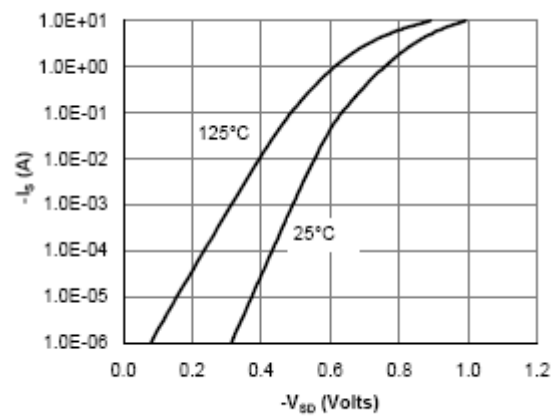
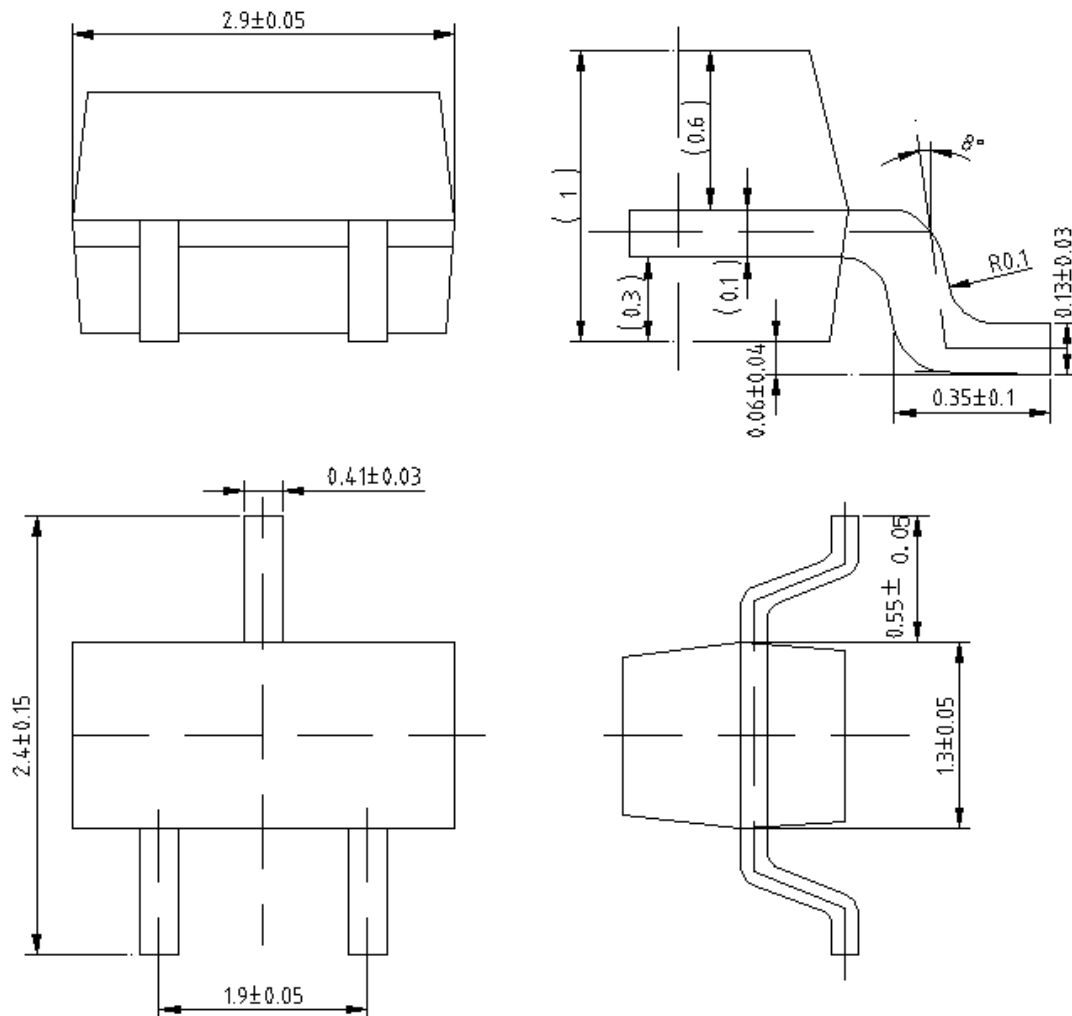

Figure 6: Body-Diode Characteristics

Package Outline Dimensions (UNIT: mm)

SOT-23



单击下面可查看定价，库存，交付和生命周期等信息

[>>SHIKUES\(时科\)](#)