

## Surface Mount Schottky Barrier Rectifier

Reverse Voltage - 40 and 60 V

Forward Current - 2.0A

### Features

- Metal silicon junction, majority carrier conduction
- For surface mounted applications
- Low power loss, high efficiency
- High forward surge current capability
- For use in low voltage, high frequency inverters, free wheeling, and polarity protection applications

### MECHANICAL DATA

- Case: SMAF
- Terminals: Solderable per MIL-STD-750, Method 2026
- Approx. Weight: 27mg 0.00086oz

### Absolute Maximum Ratings and Electrical characteristics

Ratings at 25 °C ambient temperature unless otherwise specified. Single phase, half wave, 60Hz resistive or inductive load, for capacitive load, derate by 20 %

### PINNING

PIN	DESCRIPTION
1	Cathode
2	Anode

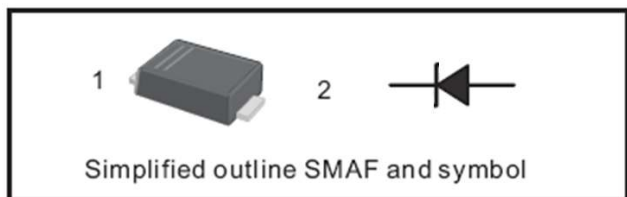

Parameter	Symbols	SS24FL	SS26FL	Units
Maximum Repetitive Peak Reverse Voltage	$V_{RRM}$	40	60	V
Maximum RMS voltage	$V_{RMS}$	28	42	V
Maximum DC Blocking Voltage	$V_{DC}$	40	60	V
Maximum Average Forward Rectified Current	$I_{F(AV)}$	2.0		A
Peak Forward Surge Current, 8.3ms Single Half Sine-wave Superimposed on Rated Load (JEDEC method)	$I_{FSM}$	50	40	A
Max Instantaneous Forward Voltage at 2 A	$V_F$	0.45	0.52	V
Maximum DC Reverse Current $T_a = 25^\circ\text{C}$ at Rated DC Reverse Voltage $T_a = 100^\circ\text{C}$	$I_R$	0.5 10	0.3 5	mA
Typical Junction Capacitance <sup>1)</sup>	$C_j$	290	130	pF
Operating Junction Temperature Range	$T_j$	-55 ~ +125		°C
Storage Temperature Range	$T_{stg}$	-55 ~ +150		°C

NOTE: 1) Measured at 1MHz and applied reverse voltage of 4 V D.C.

Fig.1 Forward Current Derating Curve

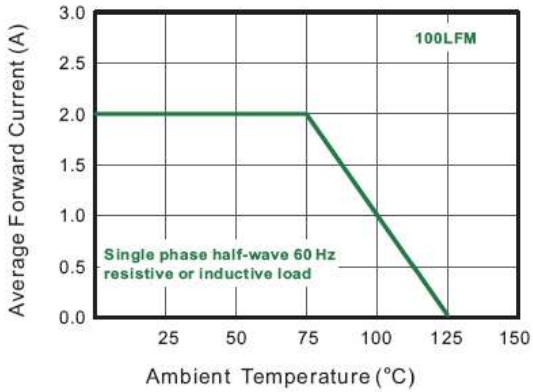

Fig.2 Typical Reverse Characteristics

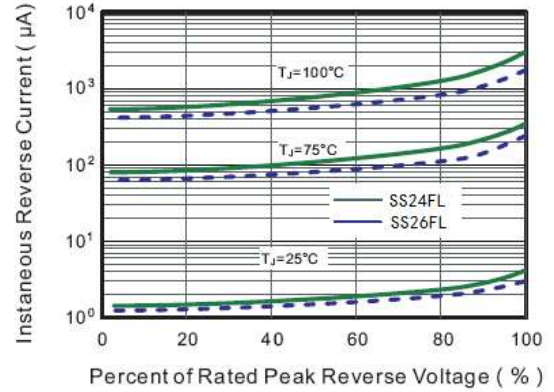

Fig.3 Typical Forward Characteristic

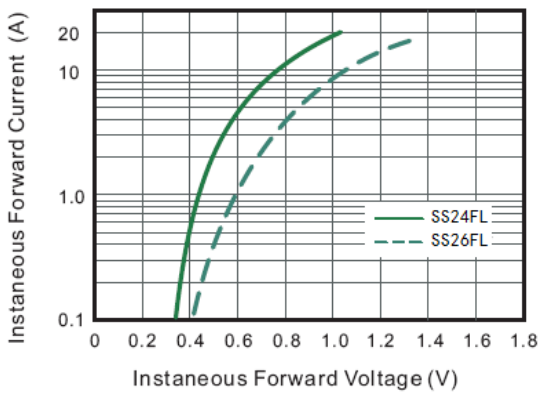

Fig.4 Typical Junction Capacitance

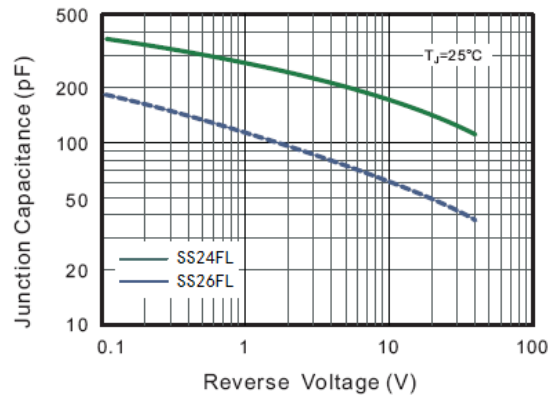
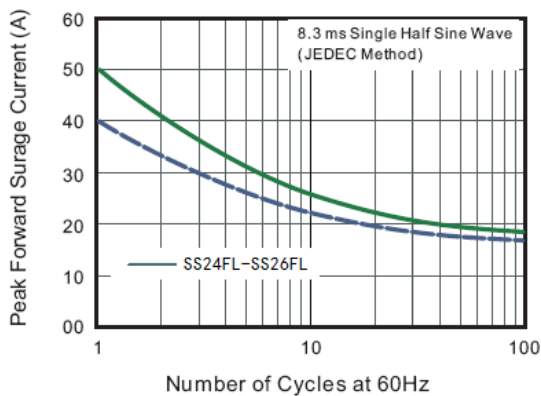

Fig.5 Maximum Non-Repetitive Peak Forward Surge Current



## PACKAGE OUTLINE

Plastic surface mounted package; 2 leads

SMAF

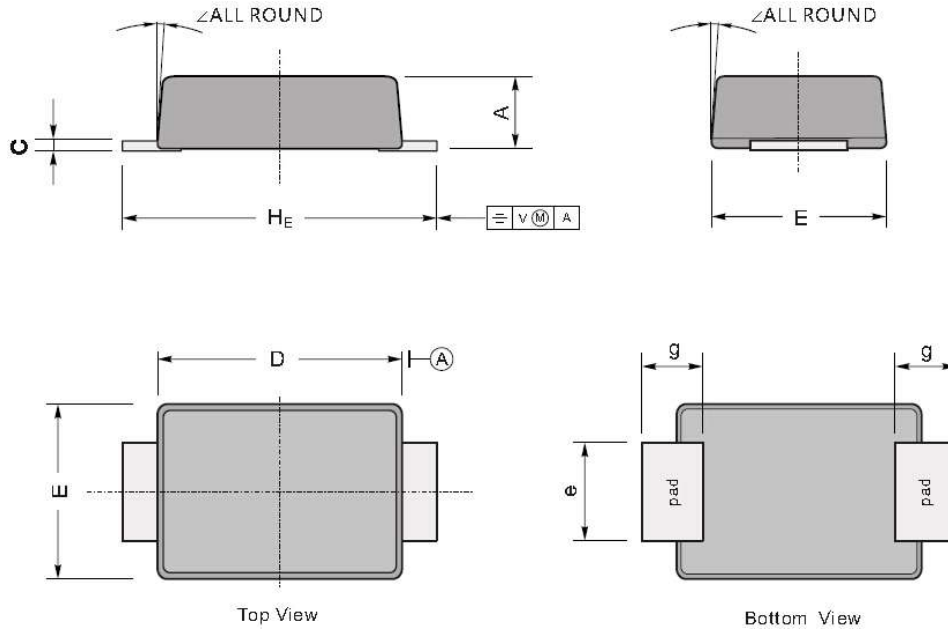

UNIT		A	C	D	E	e	g	$H_E$	$\angle$
mm	max	1.1	0.20	3.7	2.7	1.6	1.2	4.9	$7^\circ$
	min	0.9	0.12	3.3	2.4	1.3	0.8	4.4	
mil	max	43	7.9	146	106	63	47	193	
	min	35	4.7	130	94	51	31	173	

### The recommended mounting pad size

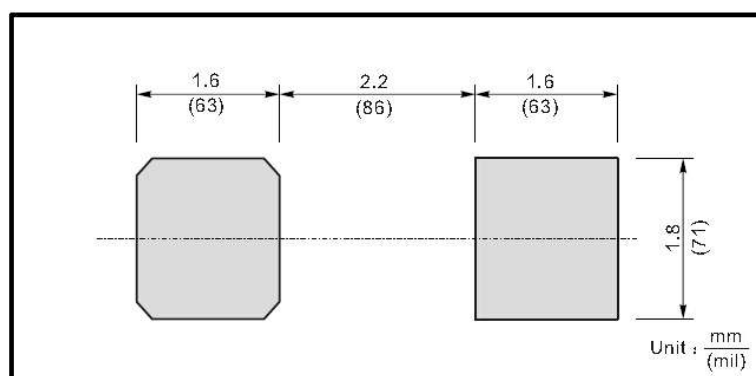

单击下面可查看定价，库存，交付和生命周期等信息

[>>SHIKUES\(时科\)](#)