

Surface Mount Schottky Barrier Rectifier
Reverse Voltage-20 to 200V Forward Current-5.0A

FEATURES

- Metal silicon junction, majority carrier conduction
- For surface mounted applications
- Low power loss, high efficiency
- High forward surge current capability
- For use in low voltage, high frequency inverters, free wheeling, and polarity protection applications

MECHANICAL DATA

- Case: SMB
- Terminals: Solderable per MIL-STD-750, Method 2026
- Approx. Weight: 0.055g / 0.002oz

PINNING

PIN	DESCRIPTION
1	Cathode
2	Anode

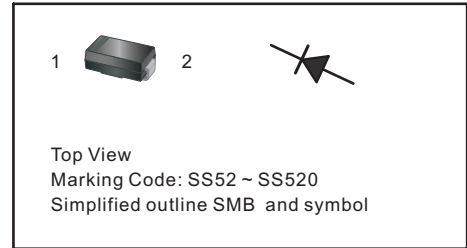

Absolute Maximum Ratings and Electrical characteristics

Ratings at 25 °C ambient temperature unless otherwise specified. Single phase, half wave, 60Hz resistive or inductive load, for capacitive load, derate by 20 %

Parameter	Symbols	SS52BG	SS54BG	SS56BG	SS58BG	SS510BG	SS512BG	SS515BG	SS520BG	Units
Maximum Repetitive Peak Reverse Voltage	V_{RRM}	20	40	60	80	100	120	150	200	V
Maximum RMS voltage	V_{RMS}	14	28	42	56	70	84	105	140	V
Maximum DC Blocking Voltage	V_{DC}	20	40	60	80	100	120	150	200	V
Maximum Average Forward Rectified Current	$I_{F(AV)}$	5.0								A
Peak Forward Surge Current, 8.3ms Single Half Sine-wave Superimposed on Rated Load (JEDEC method)	I_{FSM}	150								A
Max Instantaneous Forward Voltage at 5 A	V_F	0.55	0.70		0.85				V	
Maximum DC Reverse Current $T_a = 25^\circ\text{C}$ at Rated DC Reverse Voltage $T_a = 100^\circ\text{C}$	I_R	1.0 50	0.3 25						mA	
Typical Junction Capacitance ⁽¹⁾	C_j	500	300						pF	
Typical Thermal Resistance ⁽²⁾	$R_{\theta JA}$	50								°C/W
Operating Junction Temperature Range	T_j	-55 ~ +150								°C
Storage Temperature Range	T_{stg}	-55 ~ +150								°C

(1) Measured at 1MHz and applied reverse voltage of 4 V D.C.

(2) P.C.B. mounted with 2.0" X 2.0" (5 X 5 cm) copper pad areas.

Fig.1 Forward Current Derating Curve

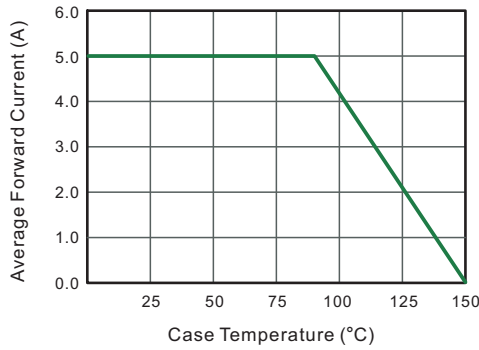

Fig.2 Typical Reverse Characteristics

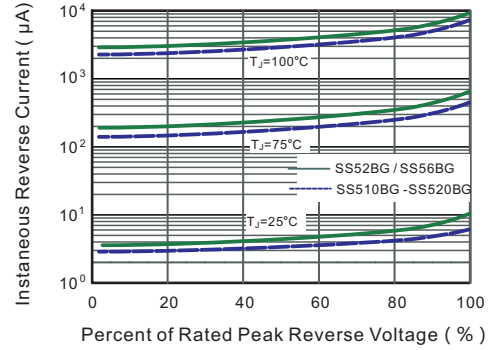

Fig.3 Typical Forward Characteristic

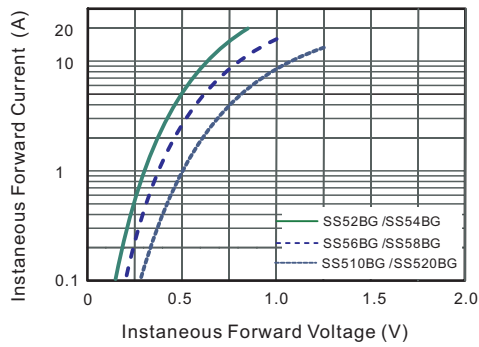

Fig.4 Typical Junction Capacitance

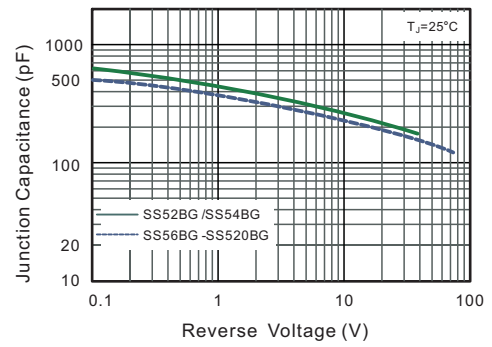

Fig.5 Maximum Non-Repetitive Peak Forward Surge Current

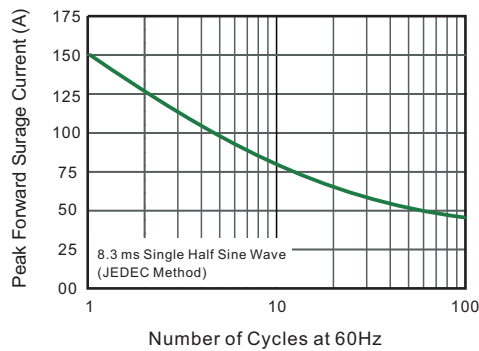
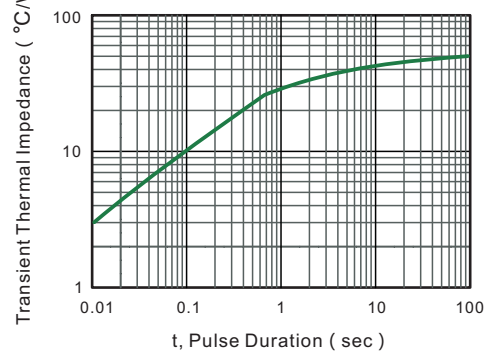

Fig.6- Typical Transient Thermal Impedance



PACKAGE OUTLINE

Plastic surface mounted package; 2 leads

SMB

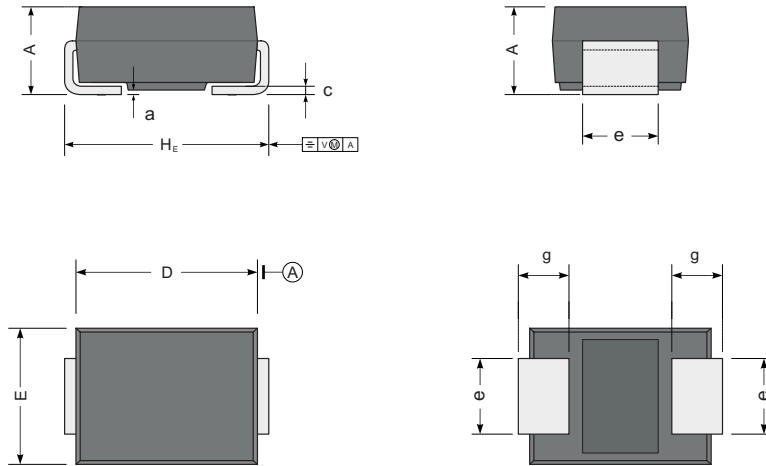

UNIT		A	D	E	H _E	a	c	e	g
mm	max	2.44	4.83	3.94	5.59	0.21	0.305	2.2	1.5
	min	2.13	4.32	3.3	5.08	0.05	0.152	1.8	0.9
mil	max	96	190	155	220	8.3	12	87	59
	min	83	170	130	200	2.0	6	71	35

The recommended mounting pad size

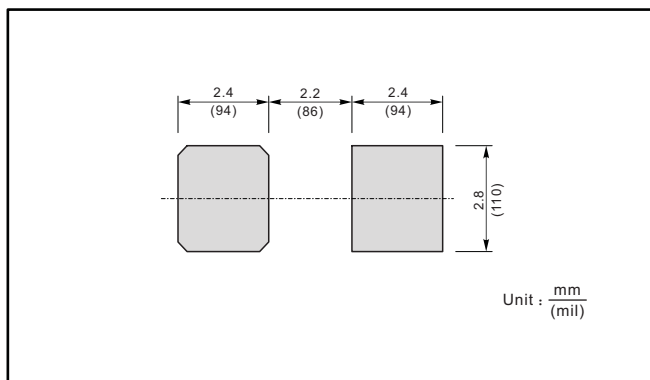

Marking

Type number	Marking code
SS52BG	SS52
SS54BG	SS54
SS56BG	SS56
SS58BG	SS58
SS510BG	SS510
SS512BG	SS512
SS515BG	SS515
SS520BG	SS520

单击下面可查看定价，库存，交付和生命周期等信息

[>>SHIKUES\(时科\)](#)