

SOT-89 Plastic-Encapsulate Transistors

2SC2383 TRANSISTOR (NPN)

FEATURE

- High voltage: $V_{CEO}=160V$
- Large continuous collector current capability

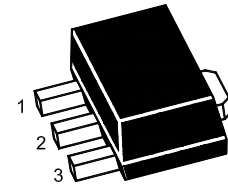

1.Base 2.Collector 3.Emitter
SOT-89 Plastic Package

MARKING: 2383

MAXIMUM RATINGS ($T_A=25^{\circ}C$ unless otherwise noted)

Symbol	Parameter	Value	Unit
V_{CBO}	Collector-Base Voltage	160	V
V_{CEO}	Collector-Emitter Voltage	160	V
V_{EBO}	Emitter-Base Voltage	6	V
I_C	Collector Current -Continuous	1	A
P_C	Collector Power Dissipation	0.5	W
T_J	Junction Temperature	150	$^{\circ}C$
T_{stg}	Storage Temperature	-55~+150	$^{\circ}C$

ELECTRICAL CHARACTERISTICS ($T_{amb}=25^{\circ}C$ unless otherwise specified)

Parameter	Symbol	Test conditions	Min	Max	Unit
Collector-base breakdown voltage	$V_{(BR)CBO}$	$I_C=100\mu A, I_E=0$	160		V
Collector-emitter breakdown voltage	$V_{(BR)CEO}^*$	$I_C=10mA, I_B=0$	160		V
Emitter-base breakdown voltage	$V_{(BR)EBO}$	$I_E=10\mu A, I_C=0$	6		V
Collector cut-off current	I_{CBO}	$V_{CB}=150V, I_E=0$		1	μA
Emitter cut-off current	I_{EBO}	$V_{EB}=6V, I_C=0$		1	μA
DC current gain	h_{FE}	$V_{CE}=5V, I_C=200mA$	100	320	
Collector-emitter saturation voltage	$V_{CE(sat)}$	$I_C=500mA, I_B=50mA$		1	V
Base-emitter voltage	V_{BE}	$I_C=5mA, V_{CE}=5V$	0.45	0.75	V
Transition frequency	f_T	$V_{CE}=5V, I_C=200mA$	20		MHz
Collector output capacitance	C_{ob}	$V_{CB}=10V, I_E=0, f=1MHz$		20	pF

* pulse test

CLASSIFICATION OF h_{FE}

Rank	O	Y
Range	100-200	160-320

Static Characteristic

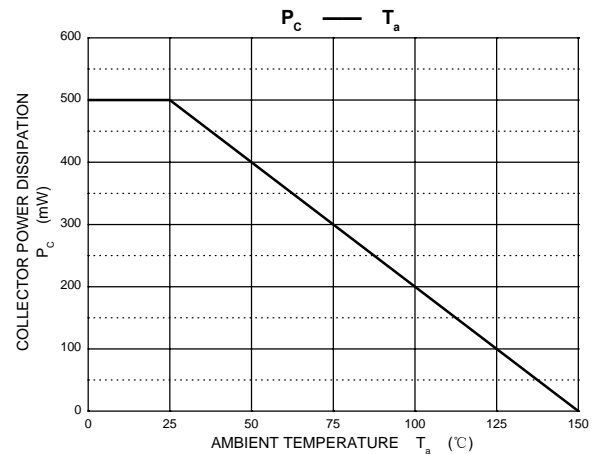
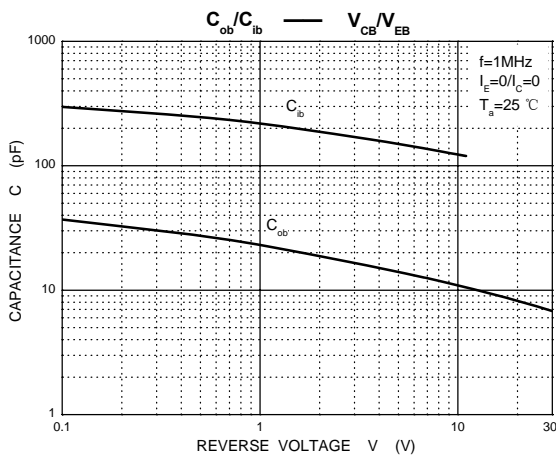
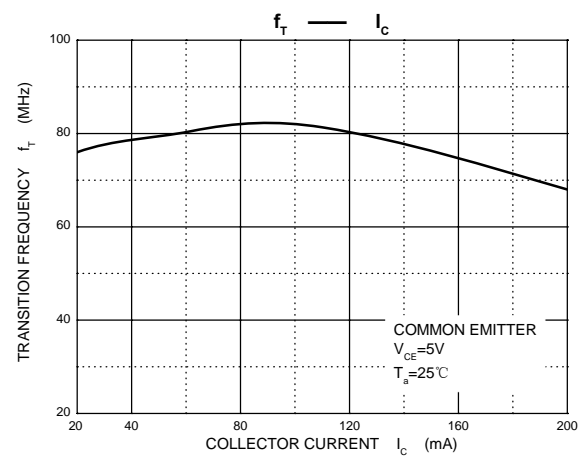
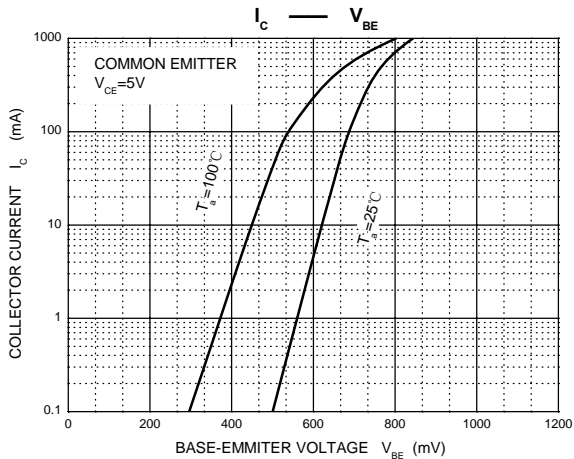
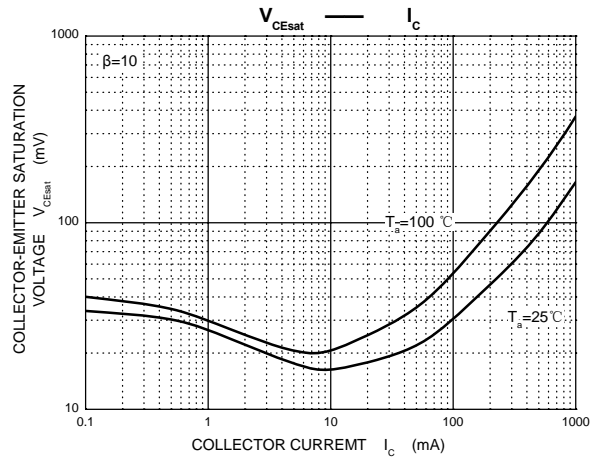
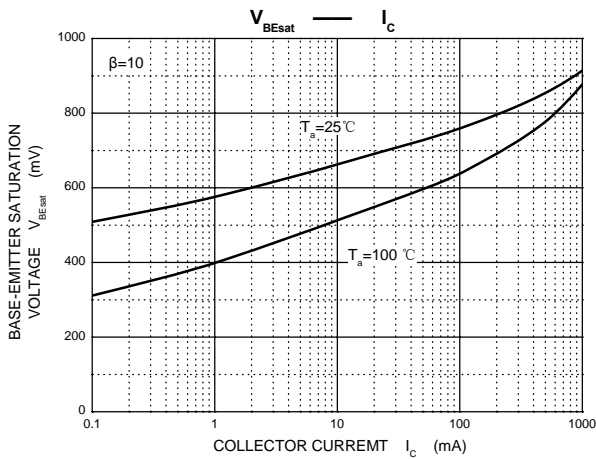
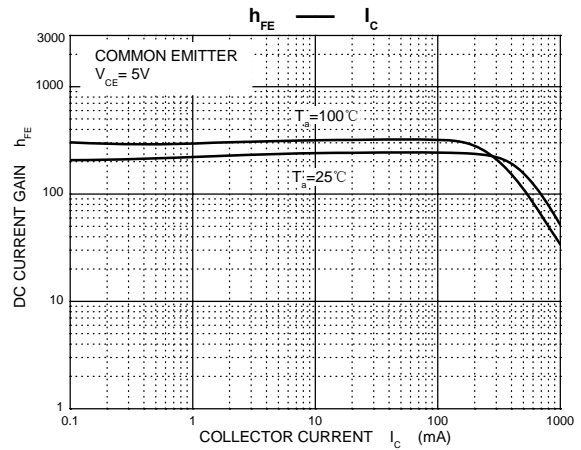
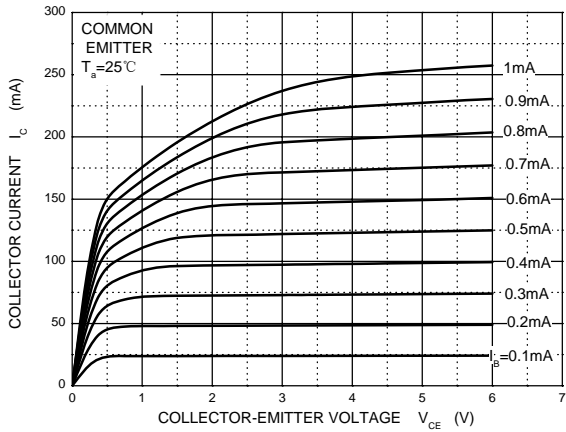

SOT-89 PACKAGE OUTLINE

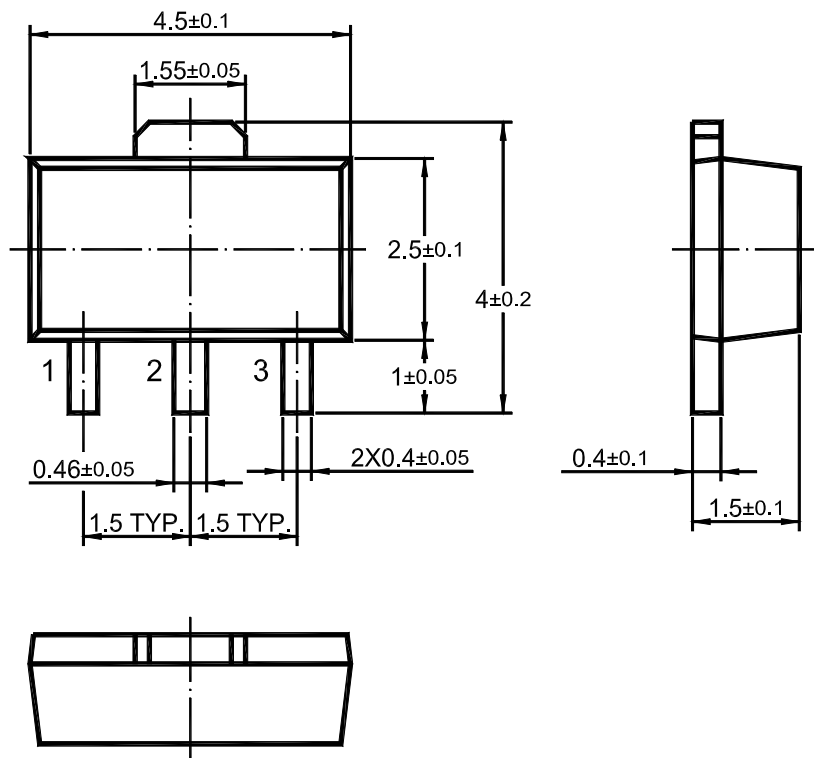

Dimensions in mm

单击下面可查看定价，库存，交付和生命周期等信息

[>>SHIKUES\(时科\)](#)