

PNP SILICON PLANAR MEDIUM POWER TRANSISTORS IN SOT89

● Features

$I_C = -1A$ Continuous Collector Current
 Low Saturation Voltage $V_{CE(sat)} < -500mV @ -0.5A$
 Gain groups 10 and 16
 Epitaxial Planar Die Construction
 Complementary NPN types: BCX54, 55, and 56

● Mechanical Data

Case: SOT89
 Case Material: Molded Plastic, "Green" Molding Compound (Note 2)
 UL Flammability Rating 94V-0
 Moisture Sensitivity: Level 1 per J-STD-020
 Terminals: Matte Tin Finish
 Weight: 0.072 grams (Approximate)

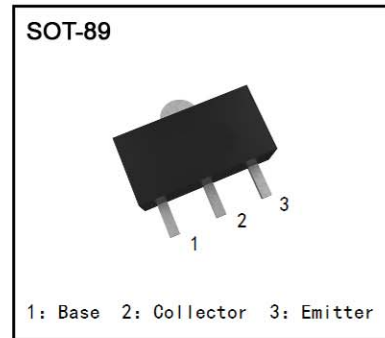

● Applications

Medium Power Switching or Amplification Applications
 AF driver and output stages

● Maximum Ratings @ $T_A = 25^\circ C$ unless otherwise specified

Characteristic	Symbol	BCX51	BCX52	BCX53	Unit
Collector-Base Voltage	V_{CB0}	-45	-60	-100	V
Collector-Emitter Voltage	V_{CE0}	-45	-60	-80	V
Emitter-Base Voltage	V_{EB0}		-5		V
Continuous Collector Current	I_C		-1		A
Peak Pulse Collector Current	I_{CM}		-1.5		A
Continuous Base Current	I_B		-100		mA
Peak Pulse Base Current	I_{BM}		-200		mA

● Thermal Characteristics @ $T_A = 25^\circ C$ unless otherwise specified

Characteristic	Symbol	Value	Unit
Power Dissipation (Note 4)	P_D	1	W
Thermal Resistance, Junction to Ambient (Note 4)	$R_{\theta JA}$	124	$^\circ C/W$
Thermal Resistance, Junction to Leads (Note 5)	$R_{\theta JL}$	10.0	$^\circ C/W$
Operating and Storage Temperature Range	T_J, T_{STG}	-65 to +150	$^\circ C$

Notes: 1. For a device surface mounted on 25mm X 25mm FR4 PCB with high coverage of single sided 1 oz copper, in still air conditions; the device is measured when operating in a steady-state condition.
 2. Thermal resistance from junction to solder-point (on the exposed collector pad).

● Thermal Characteristics

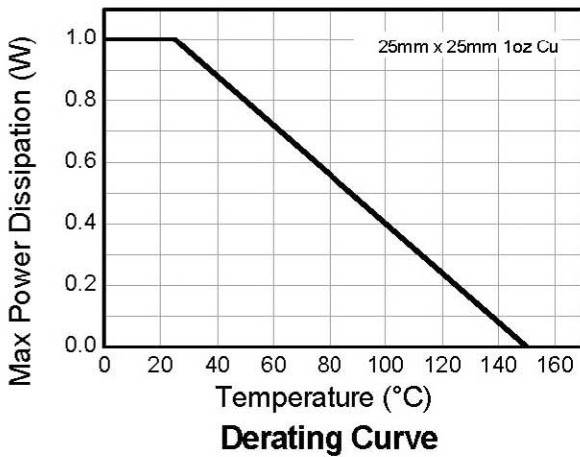
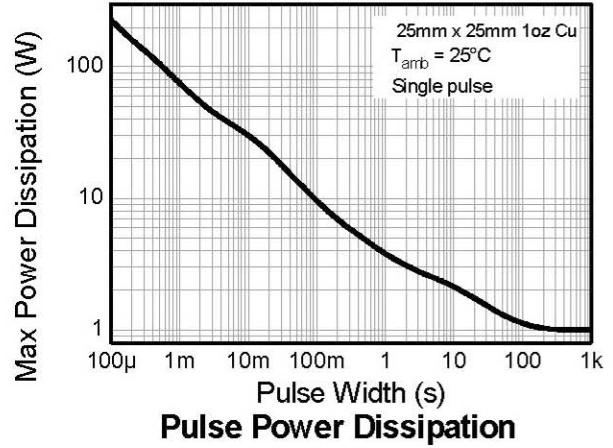
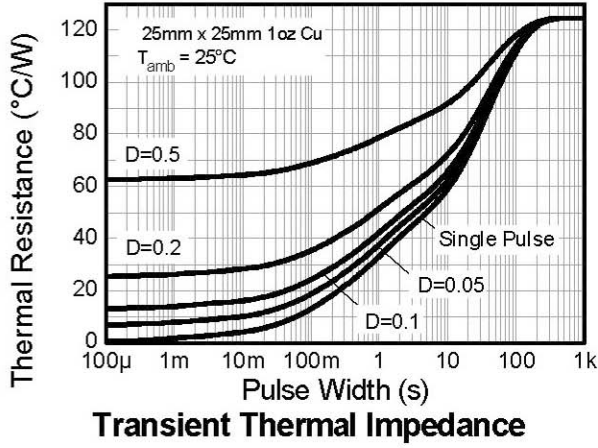

● Suggested Pad Layout

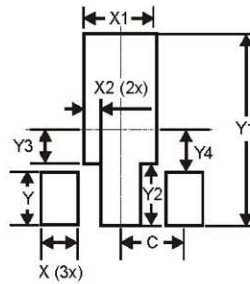

Dimensions	Value (in mm)
X	0.900
X1	1.733
X2	0.416
Y	1.300
Y1	4.600
Y2	1.475
Y3	0.950
Y4	1.125
C	1.500

● Package Outline Dimensions

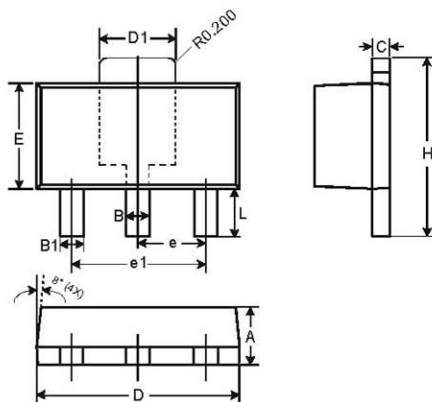

SOT89		
Dim	Min	Max
A	1.40	1.60
B	0.44	0.62
B1	0.35	0.54
C	0.35	0.43
D	4.40	4.60
D1	1.52	1.83
E	2.29	2.60
e	1.50 Typ	
e1	3.00 Typ	
H	3.94	4.25
L	0.89	1.20
All Dimensions in mm		

● **Electrical Characteristics** @ $T_A = 25^\circ\text{C}$ unless otherwise specified

Characteristic	Symbol	Min	Typ	Max	Unit	Test Condition		
Collector-Base Breakdown Voltage	BCX51	-45	-	-	V	$I_C = -100\mu\text{A}$		
	BCX52	-60	-	-				
	BCX53	-100	-	-				
Collector-Emitter Breakdown Voltage (Note 3)	BCX51	-45	-	-	V	$I_C = -10\text{mA}$		
	BCX52	-60	-	-				
	BCX53	-80	-	-				
Emitter-Base Breakdown Voltage	BV_{EBO}	-5	-	-	V	$I_E = -10\mu\text{A}$		
Collector Cut-off Current	I_{CBO}	-	-	-0.1 -20	μA	$V_{CB} = -30\text{V}$ $V_{CB} = -30\text{V}, T_A = 150^\circ\text{C}$		
Emitter Cut-off Current	I_{EBO}	-	-	-20	nA	$V_{EB} = -4\text{V}$		
Static Forward Current Transfer Ratio (Note 3)	All versions	h_{FE}	25	-	-		$I_C = -5\text{mA}, V_{CE} = -2\text{V}$ $I_C = -150\text{mA}, V_{CE} = -2\text{V}$ $I_C = -500\text{mA}, V_{CE} = -2\text{V}$	
			10 gain grp	63	-			160
			16 gain grp	100	-			250
Collector-Emitter Saturation Voltage (Note 3)	$V_{CE(sat)}$	-	-	-0.5	V	$I_C = -500\text{mA}, I_B = -50\text{mA}$		
Base-Emitter Turn-On Voltage (Note 3)	$V_{BE(on)}$	-	-	-1.0	V	$I_C = -500\text{mA}, V_{CE} = -2\text{V}$		
Transition Frequency	f_T	150	-	-	MHz	$I_C = -50\text{mA}, V_{CE} = -10\text{V}$ $f = 100\text{MHz}$		
Output Capacitance	C_{obo}	-	-	25	pF	$V_{CB} = -10\text{V}, f = 1\text{MHz}$		

Notes: 3. Measured under pulsed conditions. Pulse width $\leq 300\mu\text{s}$. Duty cycle $\leq 2\%$.

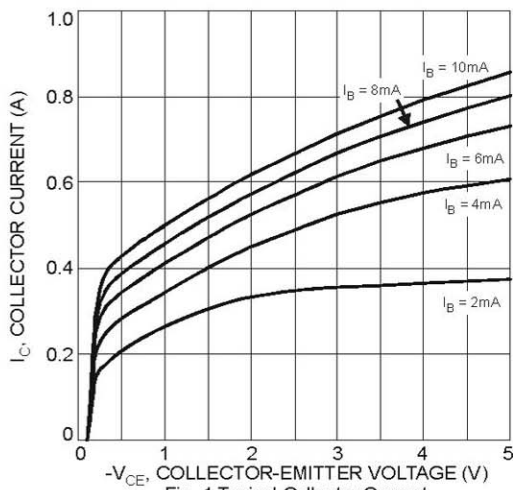

Fig. 1 Typical Collector Current vs. Collector-Emitter Voltage

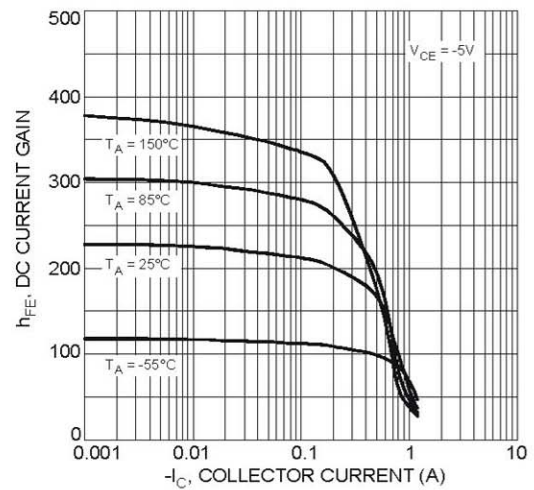

Fig. 2 Typical DC Current Gain vs. Collector Current

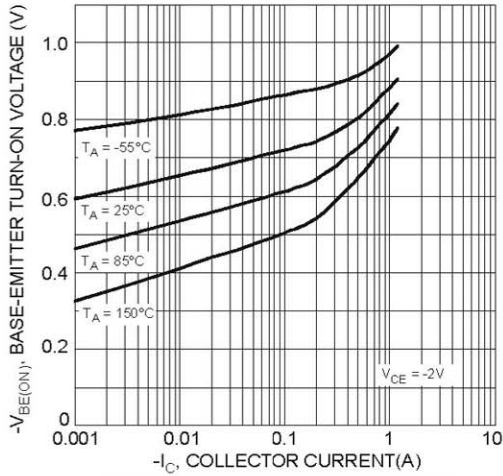

Fig 3 Typical Base-Emitter Turn-On Voltage vs. Collector Current

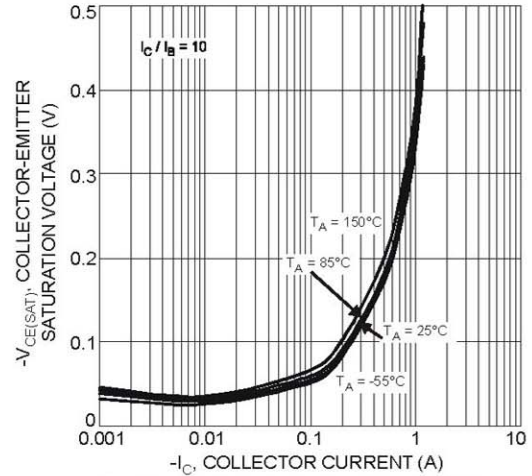

Fig. 4 Typical Collector-Emitter Saturation Voltage vs. Collector Current

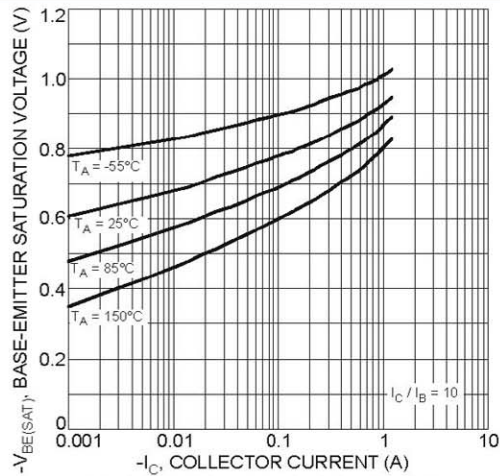

Fig. 5 Typical Base-Emitter Saturation Voltage vs. Collector Current

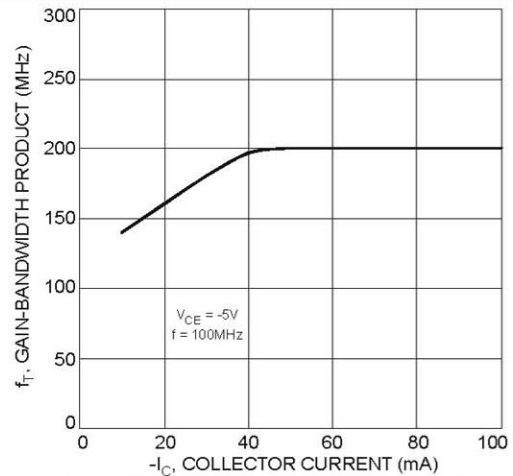

Fig. 6 Typical Gain-Bandwidth Product vs. Collector Current

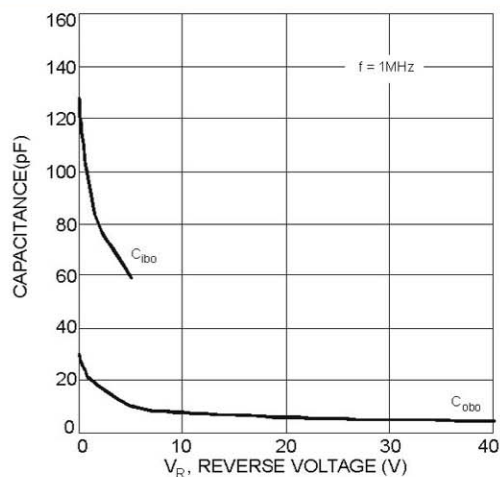

Fig. 7 Typical Capacitance Characteristics

单击下面可查看定价，库存，交付和生命周期等信息

[>>SHIKUES\(时科\)](#)