

## SOT-323 Plastic-Encapsulate MOSFETS

P-Channel 20-V(D-S) MOSFET

### FEATURE

- TrenchFET Power MOSFET

### APPLICATIONS

- Load Switch for Portable Devices
- DC/DC Converter

**MARKING: A1S**

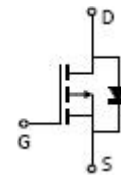
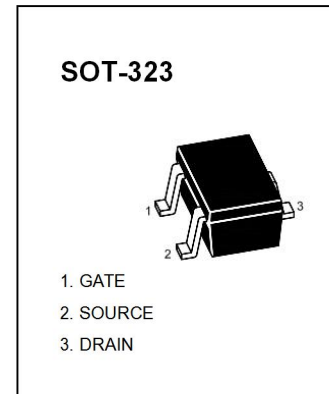

Maximum ratings ( $T_a=25^\circ\text{C}$  unless otherwise noted)

Parameter	Symbol	Value	Unit
Drain-Source Voltage	$V_{DS}$	-20	V
Gate-Source Voltage	$V_{GS}$	$\pm 8$	
Continuous Drain Current	$I_D$	-3.0	A
Pulsed Drain Current	$I_{DM}$	-10	
Continuous Source-Drain Diode Current	$I_S$	-0.72	
Maximum Power Dissipation	$P_D$	0.35	W
Thermal Resistance from Junction to Ambient( $t \leq 5s$ )	$R_{\theta JA}$	357	$^\circ\text{C/W}$
Junction Temperature	$T_J$	150	$^\circ\text{C}$
Storage Temperature	$T_{stg}$	-55 ~ +150	

**Electrical characteristics (T<sub>a</sub>=25°C unless otherwise noted)**

Parameter	Symbol	Test Condition	Min	Typ	Max	Units
<b>Static</b>						
Drain-source breakdown voltage	V <sub>(BR)DSS</sub>	V <sub>GS</sub> = 0V, I <sub>D</sub> = -250μA	-20			V
Gate-source threshold voltage	V <sub>GS(th)</sub>	V <sub>DS</sub> = V <sub>GS</sub> , I <sub>D</sub> = -250μA	-0.4		-1	
Gate-source leakage	I <sub>GSS</sub>	V <sub>DS</sub> = 0V, V <sub>GS</sub> = ±8V			±100	nA
Zero gate voltage drain current	I <sub>DSS</sub>	V <sub>DS</sub> = -16V, V <sub>GS</sub> = 0V			-1	μA
Drain-source on-state resistance <sup>a</sup>	R <sub>Ds(on)</sub>	V <sub>GS</sub> = -4.5V, I <sub>D</sub> = -3.0A		0.090	0.110	Ω
		V <sub>GS</sub> = -2.5V, I <sub>D</sub> = -2.0A		0.110	0.140	
Forward transconductance <sup>a</sup>	g <sub>fs</sub>	V <sub>DS</sub> = -5V, I <sub>D</sub> = -2.8A		6.5		S
<b>Dynamic<sup>b</sup></b>						
Input capacitance	C <sub>iss</sub>	V <sub>DS</sub> = -10V, V <sub>GS</sub> = 0V, f = 1MHz		405		pF
Output capacitance	C <sub>oss</sub>			75		
Reverse transfer capacitance	C <sub>rss</sub>			55		
Total gate charge	Q <sub>g</sub>	V <sub>DS</sub> = -10V, V <sub>GS</sub> = -4.5V, I <sub>D</sub> = -3A		5.5	10	nC
				3.3	6	
Gate-source charge	Q <sub>gs</sub>	V <sub>DS</sub> = -10V, V <sub>GS</sub> = -2.5V, I <sub>D</sub> = -3A		0.7		
Gate-drain charge	Q <sub>gd</sub>			1.3		
Gate resistance	R <sub>g</sub>	f = 1MHz		6.0		Ω
Turn-on delay time	t <sub>d(on)</sub>	V <sub>DD</sub> = -10V, R <sub>L</sub> = 10Ω, I <sub>D</sub> = -1A, V <sub>GEN</sub> = - 4.5V, R <sub>g</sub> = 1Ω		11	20	ns
Rise time	t <sub>r</sub>			35	60	
Turn-off delay time	t <sub>d(off)</sub>			30	50	
Fall time	t <sub>f</sub>			10	20	
<b>Drain-source body diode characteristics</b>						
Continuous source-drain diode current	I <sub>S</sub>	T <sub>C</sub> = 25°C			-1.3	A
Pulse diode forward current <sup>a</sup>	I <sub>SM</sub>				-10	
Body diode voltage	V <sub>SD</sub>	I <sub>S</sub> = -0.7A		-0.8	-1.2	V

**Notes :**

a. Pulse Test : Pulse Width < 300μs, Duty Cycle ≤ 2%.

b. Guaranteed by design, not subject to production testing.

## Typical Characteristics

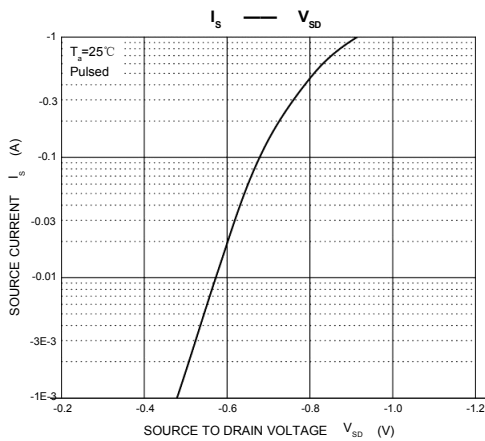
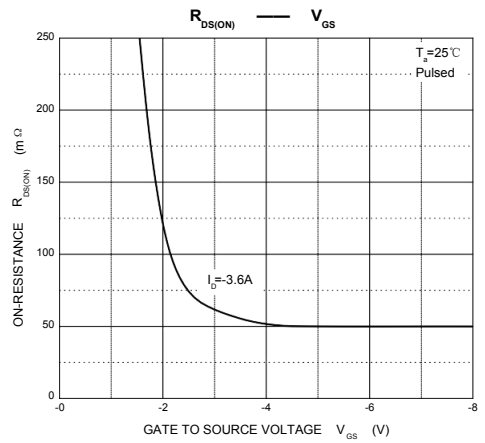
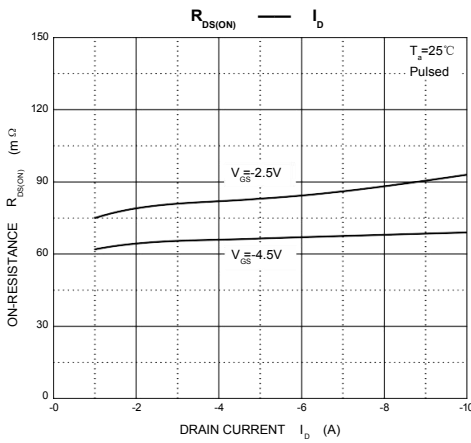
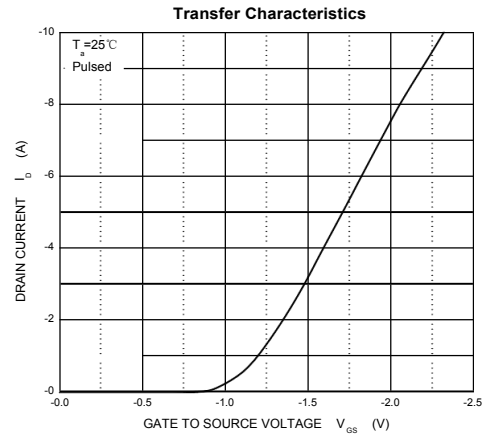
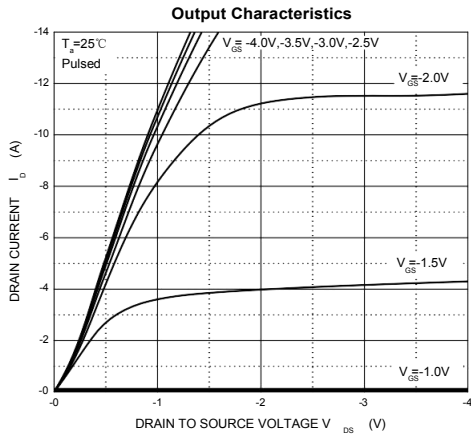

## SOT-323 Package Outline Dimensions

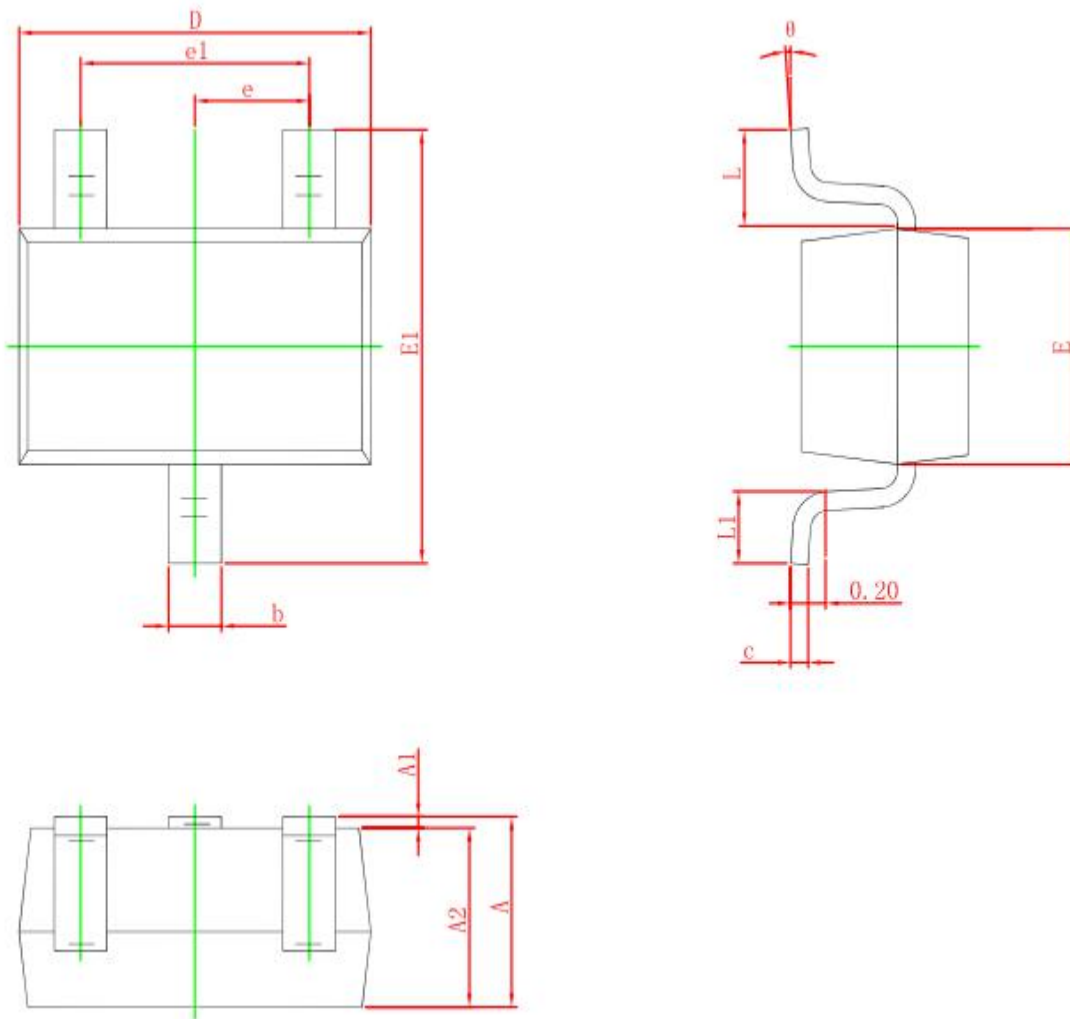

Symbol	Dimensions In Millimeters		Dimensions In Inches	
	Min.	Max.	Min.	Max.
A	0.900	1.100	0.035	0.043
A1	0.000	0.100	0.000	0.004
A2	0.900	1.000	0.035	0.039
b	0.200	0.400	0.008	0.016
c	0.080	0.150	0.003	0.006
D	2.000	2.200	0.079	0.087
E	1.150	1.350	0.045	0.053
E1	2.150	2.450	0.085	0.096
e	0.650 TYP.		0.026 TYP.	
e1	1.200	1.400	0.047	0.055
L	0.525 REF.		0.021 REF.	
L1	0.260	0.460	0.010	0.018
θ	0°	8°	0°	8°

单击下面可查看定价，库存，交付和生命周期等信息

[>>SHIKUES\(时科\)](#)