

SCHOTTKY BARRIER RECTIFIERS

FEATURES

- High breakdown voltage
- Low turn-on voltage
- Guard ring construction for transient protection

MECHANICAL DATA

- Case: SOD-323G
- Terminals: Solderable per MIL-STD-750, Method 2026
- Approx. Weight: 5.48mg / 0.00019oz

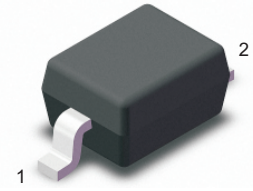

1 Cathode

2 Anode

Top View

Marking Code: S9

Simplified outline SOD-323G and symbol

Maximum Ratings at 25 °C

Parameter	Symbols	BAT46WS	Units
Maximum Repetitive Peak Reverse Voltage	V_{RRM}	100	V
Working peak reverse voltage	V_{RWM}	100	V
Continuous Forward Current	I_F	150	mA
Repetitive peak forward current (Note 1) @ $t_p < 1.0s$, Duty Cycle < 50%	I_{FRM}	350	mA
Non-repetitive Peak Forward Surge Current at 8.3ms	I_{FSM}	25	A
Power Dissipation	P_D	200	mW
Thermal resistance junction to ambient air	R_{thJA}	500	°C/W
Operating and Storage Temperature Range	T_j, T_{stg}	-55 ~ +150	°C

ELECTRICAL CHARACTERISTICS (Ta=25°C unless otherwise specified)

Parameter	Symbols	BAT46WS	Units
Reverse Breakdown Voltage at $I_R=100\mu A$ (NOTE 2)	$V_{(BR)R}$	100	V
Maximum Forward Voltage (NOTE 2)	V_F	0.45 1.0	V
Peak Reverse Current	I_R	0.3 0.5 1 2	μA
Diodes Capacitance	C_T	20 12	pF

NOTES:

- (1) Part mounted on FR-4 board with recommended pad layout.
 (2) Short duration pulse test used to minimize self-heating effect.

Fig.1 Power Derating Curve

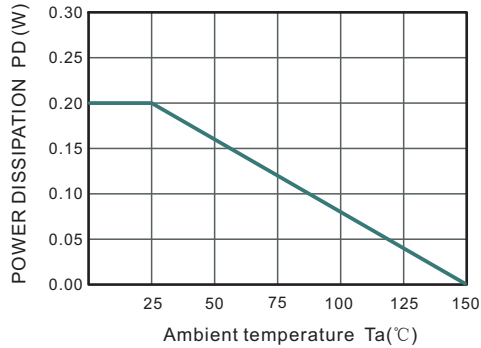

Fig.2 Typical Reverse Characteristics

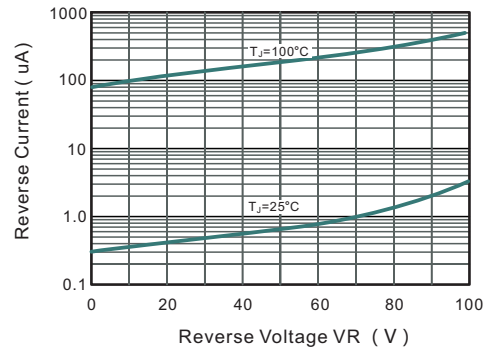

Fig.4 Typical Forward Voltage

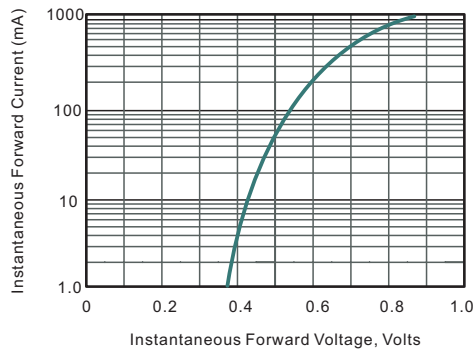

Fig.3 Typical Junction Capacitance

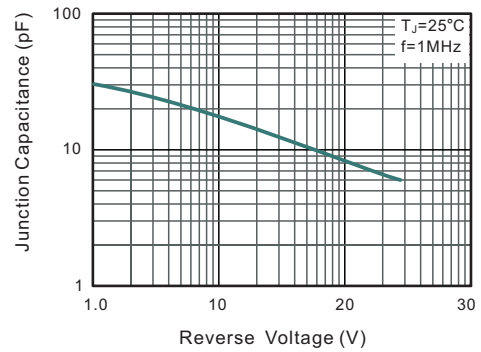

Fig.5 Maximum Non-Repetitive Peak Forward Surge Current

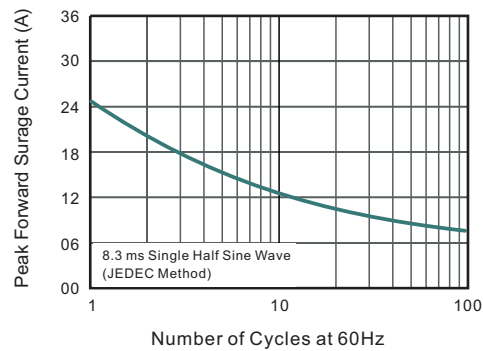
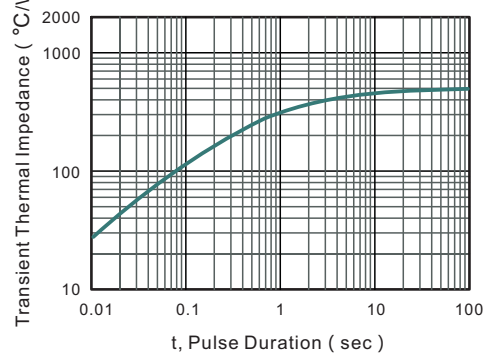

Fig.6 Typical Transient Thermal Impedance



PACKAGE OUTLINE

Plastic surface mounted package; 2 leads

SOD-323G

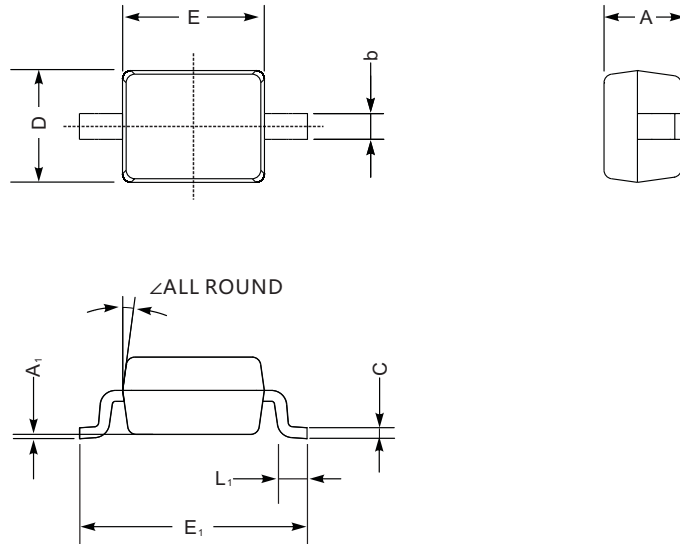

SOD-323G mechanical data

UNIT		A	C	D	E	E ₁	b	L ₁	A ₁	∠
mm	max	1.1	0.15	1.4	1.8	2.75	0.4	0.45	0.2	9°
	min	0.8	0.08	1.2	1.4	2.55	0.25	0.2	—	
mil	max	43	5.9	55	70	108	16	16	8	
	min	32	3.1	47	63	100	9.8	7.9	—	

The recommended mounting pad size

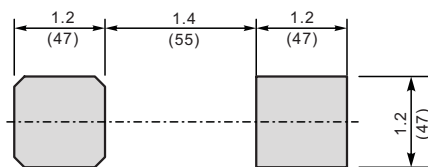

Unit: $\frac{\text{mm}}{\text{mil}}$

Marking

Type number	Marking code
BAT46WS	S9

单击下面可查看定价，库存，交付和生命周期等信息

[>>SHIKUES\(时科\)](#)