

Silicon PIN diode

FEATURES

- High voltage, current controlled
- RF resistor for RF attenuators and switches
- Low diode capacitance
- Low diode forward resistance
- Low series inductance
- For applications up to 3 GHz.

APPLICATIONS

- RF attenuators and switches.

DESCRIPTION

Planar PIN diode in a SOD323 very small plastic SMD package.

LIMITING VALUES

In accordance with the Absolute Maximum Rating System (IEC 134).

SYMBOL	PARAMETER	CONDITIONS	MIN.	MAX.	UNIT
V_R	continuous reverse voltage		–	175	V
I_F	continuous forward current		–	100	mA
P_{tot}	total power dissipation	$T_s = 90\text{ °C}$	–	500	mW
T_{stg}	storage temperature		–65	+150	°C
T_j	junction temperature		–65	+150	°C

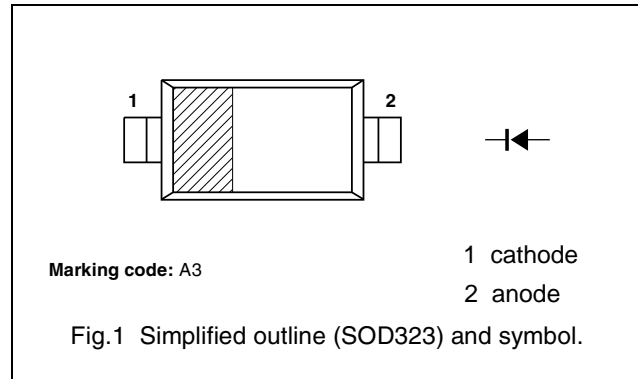

ELECTRICAL CHARACTERISTICS $T_j = 25\text{ °C}$ unless otherwise specified.

SYMBOL	PARAMETER	CONDITIONS	MIN.	TYP.	MAX.	UNIT
V_F	forward voltage	$I_F = 50\text{ mA}$	–	0.95	1.1	V
I_R	reverse leakage current	$V_R = 175\text{ V}$	–	–	10	μA
		$V_R = 20\text{ V}$	–	–	1	μA
C_d	diode capacitance	$V_R = 0; f = 1\text{ MHz}$	–	0.48	–	pF
		$V_R = 1\text{ V}; f = 1\text{ MHz}$	–	0.35	–	pF
		$V_R = 20\text{ V}; f = 1\text{ MHz}$	–	0.23	0.35	pF
r_D	diode forward resistance	$I_F = 0.5\text{ mA}; f = 100\text{ MHz}; \text{note 1}$	–	20	40	Ω
		$I_F = 1\text{ mA}; f = 100\text{ MHz}; \text{note 1}$	–	10	20	Ω
		$I_F = 10\text{ mA}; f = 100\text{ MHz}; \text{note 1}$	–	2	3.8	Ω
		$I_F = 100\text{ mA}; f = 100\text{ MHz}; \text{note 1}$	–	0.7	1.35	Ω
τ_L	charge carrier life time	when switched from $I_F = 10\text{ mA}$ to $I_R = 6\text{ mA}; R_L = 100\text{ }\Omega$; measured at $I_R = 3\text{ mA}$	–	1.55	–	μs
L_S	series inductance		–	1.68	–	nH

Note 1. Guaranteed on AQL basis: inspection level S4, AQL 1.0.

THERMAL CHARACTERISTICS

SYMBOL	PARAMETER	VALUE	UNIT
$R_{th\ j-s}$	thermal resistance from junction to soldering point	120	K/W

GRAPHICAL DATA

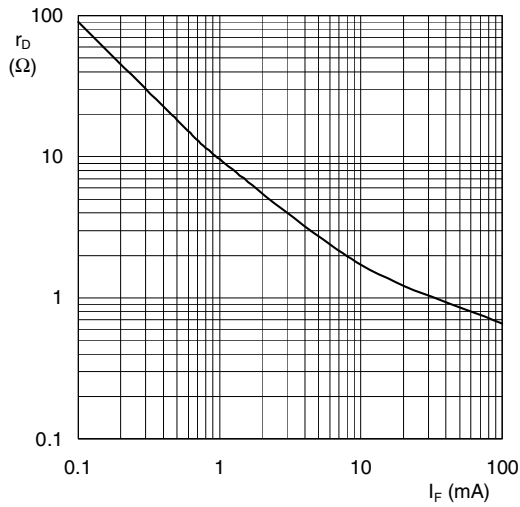
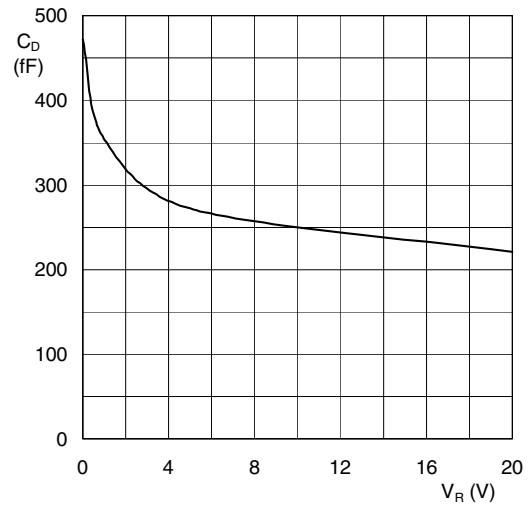
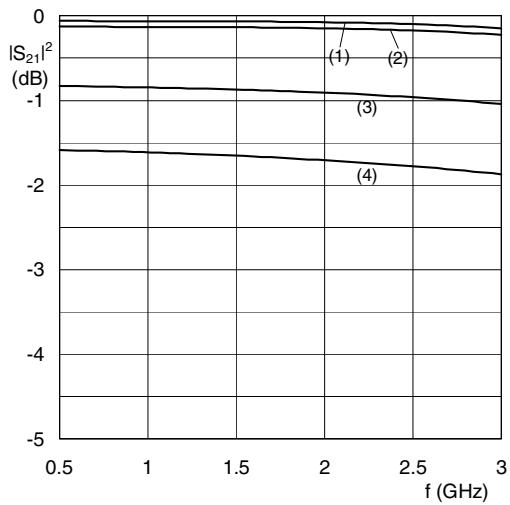

Fig.2 Forward resistance as a function of forward current; typical values.



f:

Fig.3 Diode capacitance as a function of reverse voltage; typical values.



(1) $I_F = 100$ mA.; (2) $I_F = 10$ mA.; (3) $I_F = 1$ mA.; (4) $I_F = 0.5$ mA.

Diode inserted in series with a 50 Ω stripline circuit and biased via the analyzer Tee network.

$T_{amb} = 25$ °C.

Fig.4 Insertion loss ($|S_{21}|^2$) of the diode as a function of frequency; typical values.

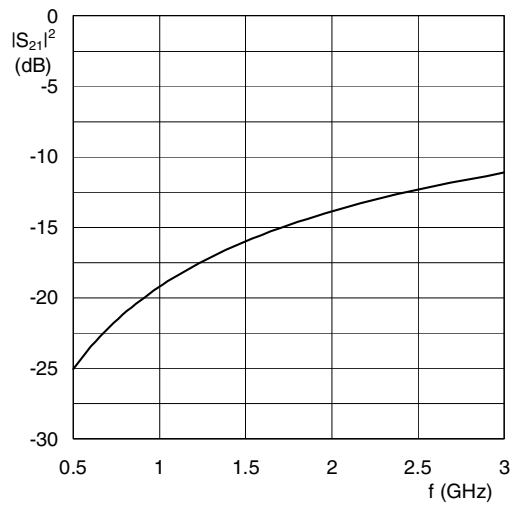

Diode zero biased and inserted in series with a 50 Ω stripline circuit.

$T_{amb} = 25$ °C.

Fig.5 Isolation ($|S_{21}|^2$) of the diode as a function of frequency; typical values.

PACKAGE OUTLINE

Plastic surface mounted package; 2 leads

SOD323

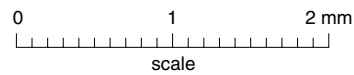
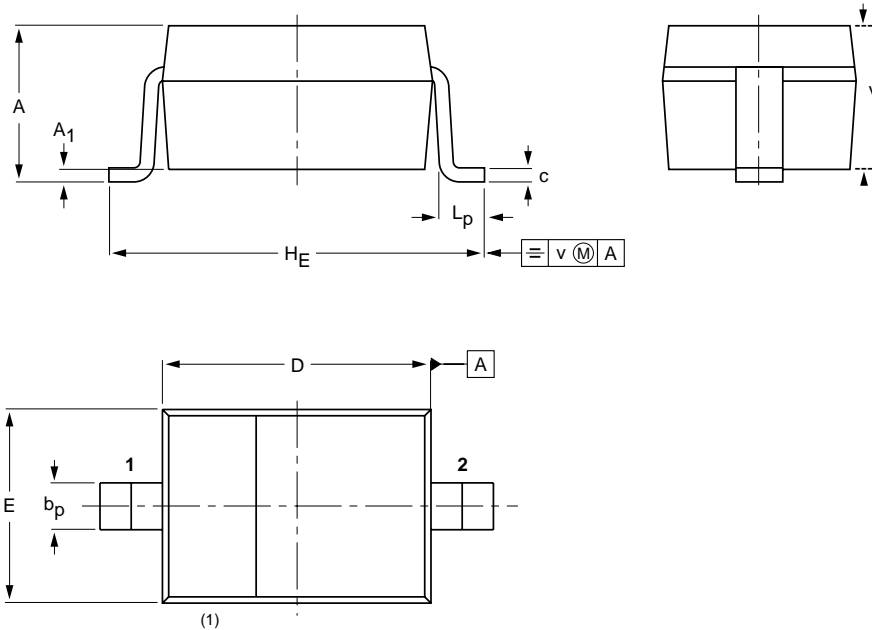

DIMENSIONS (mm are the original dimensions)

UNIT	A	A ₁	b _p	c	D	E	H _E	L _p	v	
mm	1.0	0.10	0.35	0.15	1.8	1.40	2.7	0.40	0.90	
	---	-0.00	0.25	0.08	1.6	1.20	2.5	0.25	0.80	

Note

1. The marking bar indicates the cathode.

单击下面可查看定价，库存，交付和生命周期等信息

[>>SHIKUES\(时科\)](#)