

N-Channel Enhancement Mode MOSFET

Feature

- 30V/4.5A, $R_{DS(ON)} = 35\text{m}\Omega(\text{MAX}) @V_{GS} = 10\text{V}$.
 $R_{DS(ON)} = 40\text{m}\Omega(\text{MAX}) @V_{GS} = 4.5\text{V}$.
 $R_{DS(ON)} = 55\text{m}\Omega(\text{MAX}) @V_{GS} = 2.5\text{V}$.
- Super High dense cell design for extremely low $R_{DS(ON)}$.
- Reliable and Rugged.
- SOT-23 for Surface Mount Package.



SOT-23

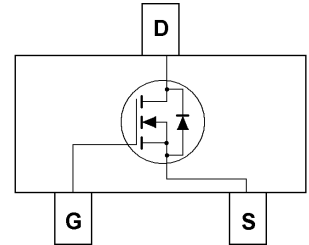

Applications

- Power Management
 Portable Equipment and Battery Powered Systems.

Absolute Maximum Ratings $T_A = 25^\circ\text{C}$ Unless Otherwise noted

Parameter	Symbol	Limit	Units
Drain-Source Voltage	V_{DS}	30	V
Gate-Source Voltage	V_{GS}	± 12	V
Drain Current-Continuous	I_D	4.5	A

Electrical Characteristics $T_A = 25^\circ\text{C}$ Unless Otherwise noted

Parameter	Symbol	Test Conditions	Min	Typ.	Max	Units
Off Characteristics						
Drain to Source Breakdown Voltage	BVDSS	$V_{GS} = 0\text{V}, I_D = 250\mu\text{A}$	30	-	-	V
Zero-Gate Voltage Drain Current	I_{DSS}	$V_{DS} = 30\text{V}, V_{GS} = 0\text{V}$	-	-	1	μA
Gate Body Leakage Current, Forward	I_{GSSF}	$V_{GS} = 12\text{V}, V_{DS} = 0\text{V}$	-	-	100	nA
Gate Body Leakage Current, Reverse	I_{GSSR}	$V_{GS} = -12\text{V}, V_{DS} = 0\text{V}$	-	-	-100	nA
On Characteristics						
Gate Threshold Voltage	$V_{GS(th)}$	$V_{GS} = V_{DS}, I_D = 250\mu\text{A}$	0.6	-	1.5	V
Static Drain-source On-Resistance	$R_{DS(ON)}$	$V_{GS} = 10\text{V}, I_D = 5.8\text{A}$	-	30	35	$\text{m}\Omega$
		$V_{GS} = 4.5\text{V}, I_D = 5\text{A}$	-	33	40	$\text{m}\Omega$
		$V_{GS} = 2.5\text{V}, I_D = 4\text{A}$	-	45	55	$\text{m}\Omega$
Drain-Source Diode Characteristics and Maximum Ratings						
Drain-Source Diode Forward Voltage	VSD	$V_{GS} = 0\text{V}, I_S = 1.25\text{A}$			1.2	V

Dynamic					
Q_g	Total Gate Charge	$V_{DS}=15V, V_{GS}=10V, I_D=2A$	8.5	12	nC
Q_{gs}	Gate-Source Charge		1.1		
Q_{gd}	Gate-Drain Charge		1.8		
t_{on}	Turn-on Time	$V_{DD}=15V, I_D=2A, V_{GS}=10V, R_G=6\Omega$		40	ns
$t_{d(ON)}$	Turn-on Delay time		11		
t_r	Turn-on Rise Time		17		
$T_{d(off)}$	Turn-off Delay Time		37		
t_f	Turn-off Fall Time		20		
t_{off}	Turn-off Time			60	

Typical Characteristics

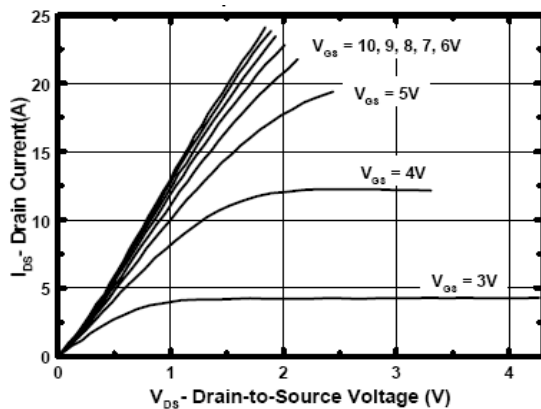

Figure 1. Output Characteristics

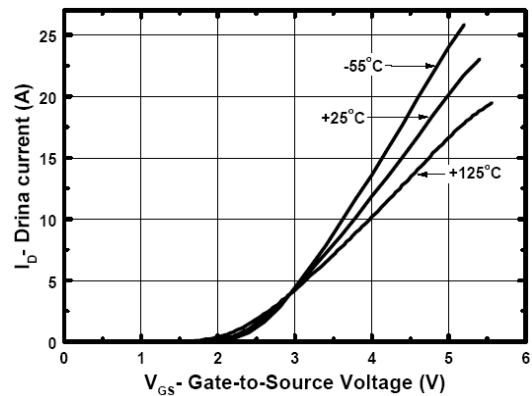

Figure 2. Transfer Characteristics

Typical Characteristics

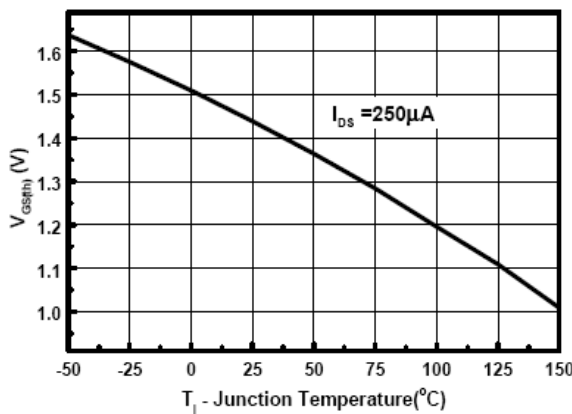

Figure 3. Gate Threshold Variation with Temperature

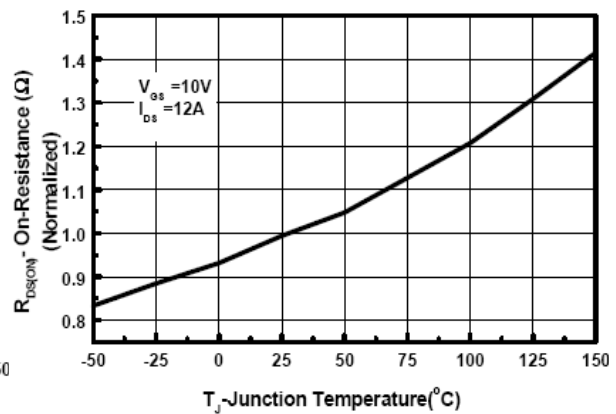

Figure 4. On-Resistance Variation with Temperature

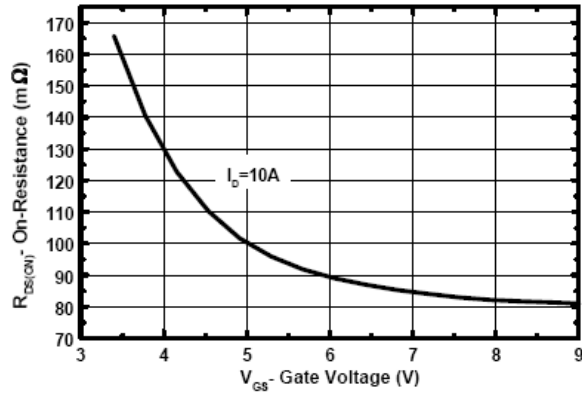

Figure 5. On-Resistance vs. Gate-to-Source Voltage

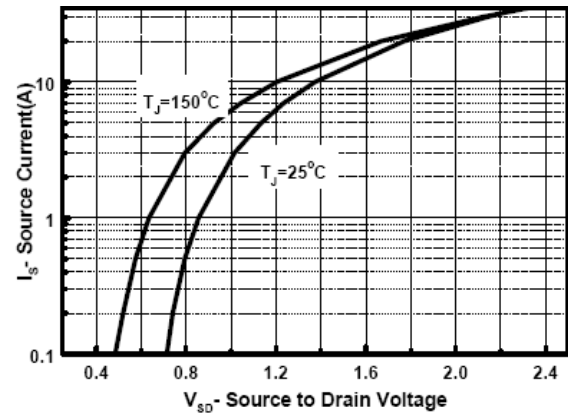
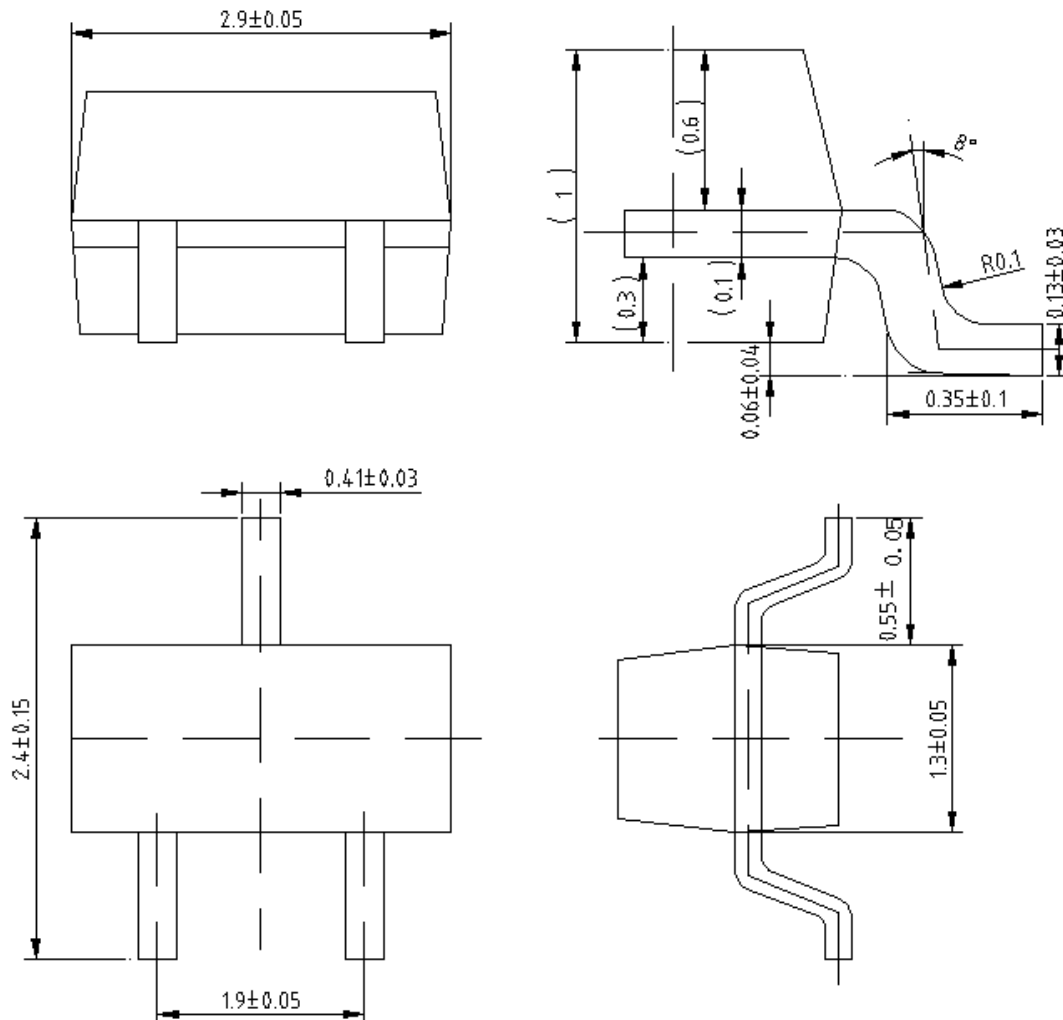

Figure 6. Source-Drain Diode Forward

Package Outline Dimensions (UNIT: mm)

SOT-23



单击下面可查看定价，库存，交付和生命周期等信息

[>>SHIKUES\(时科\)](#)