

## 1.2A SURFACE MOUNT GLASS PASSIVATED BRIDGE RECTIFIER

### FEATURES:

- Glass Passivated Chip Junction
- Reverse Voltage - 100 to 1000 V
- Forward Current - 1.2A
- High Surge Current Capability
- Designed for Surface Mount Application

### MECHANICAL DATA

- Case: ABS/LBF
- Terminals: Solderable per MIL-STD-750, Method 2026
- Approx. Weight: 88mg / 0.0031oz

### PINNING

PIN	DESCRIPTION
1	Input Pin ( ~ )
2	Input Pin ( ~ )
3	Output Anode ( + )
4	Output Cathode ( - )

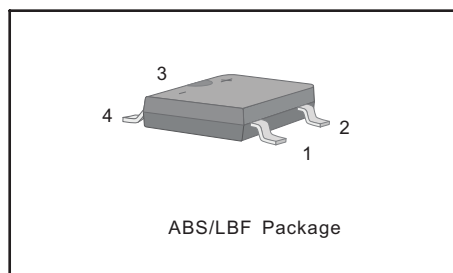

### Maximum Ratings and Electrical characteristics

Ratings at 25 °C ambient temperature unless otherwise specified. Single phase half-wave 60 Hz, resistive or inductive load , for capacitive load current derate by 20 %.

Parameter	Symbols	ABS1K	ABS2K	ABS4K	ABS6K	ABS8K	ABS10K	Units
Maximum Repetitive Peak Reverse Voltage	$V_{RRM}$	100	200	400	600	800	1000	V
Maximum RMS voltage	$V_{RMS}$	70	140	280	420	560	700	V
Maximum DC Blocking Voltage	$V_{DC}$	100	200	400	600	800	1000	V
Average Rectified Output Current at $T_c = 125\text{ }^\circ\text{C}$	$I_o$	1.2						A
Peak Forward Surge Current 8.3 ms Single Half Sine Wave Superimposed on Rated Load (JEDEC Method)	$I_{FSM}$	40						A
Forward Voltage per element @ $I_F = 1.2\text{A}$	$V_F$	1.1						V
Maximum DC Reverse Current at Rated DC Blocking Voltage @ $T_A = 25\text{ }^\circ\text{C}$ @ $T_A = 125\text{ }^\circ\text{C}$	$I_R$	5 100						$\mu\text{A}$
Typical Junction Capacitance ( Note1 )	$C_j$	18						pF
Typical Thermal Resistance ( Note2 )	$R_{\theta JA}$ $R_{\theta JC}$	70 18						$^\circ\text{C/W}$
Operating and Storage Temperature Range	$T_j, T_{stg}$	-55 ~ +150						$^\circ\text{C}$

Note: 1. Measured at 1MHz and applied reverse voltage of 4 V D.C.

2. Mounted on glass epoxy PC board with 4×1.5"×1.5" ( 3.81×3.81 cm ) copper pad.

**Fig.1 Average Rectified Output Current Derating Curve**

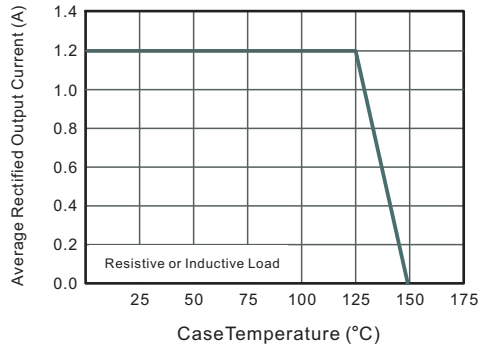

**Fig.2 Typical Reverse Characteristics**

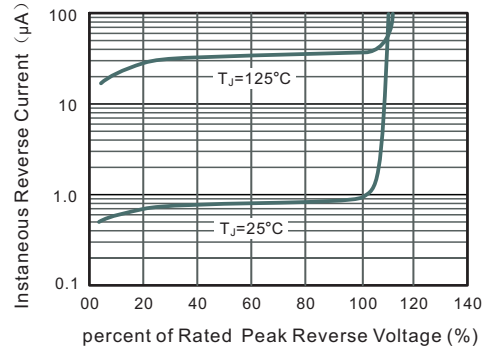

**Fig.3 Typical Instantaneous Forward Characteristics**

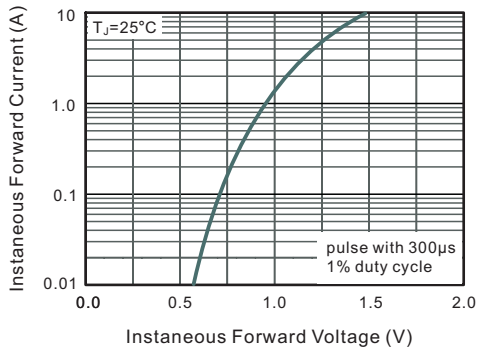

**Fig.4 Typical Junction Capacitance**

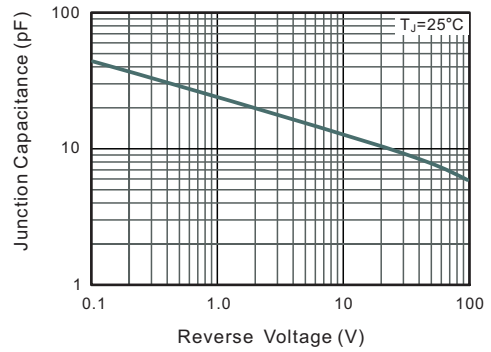

**Fig.5 Maximum Non-Repetitive Peak Forward Surge Current**

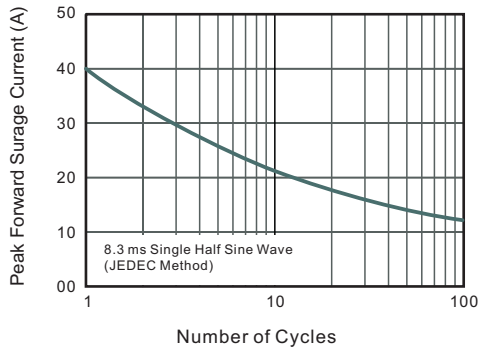

## PACKAGE OUTLINE

Plastic surface mounted package; 4 leads

ABS/LBF

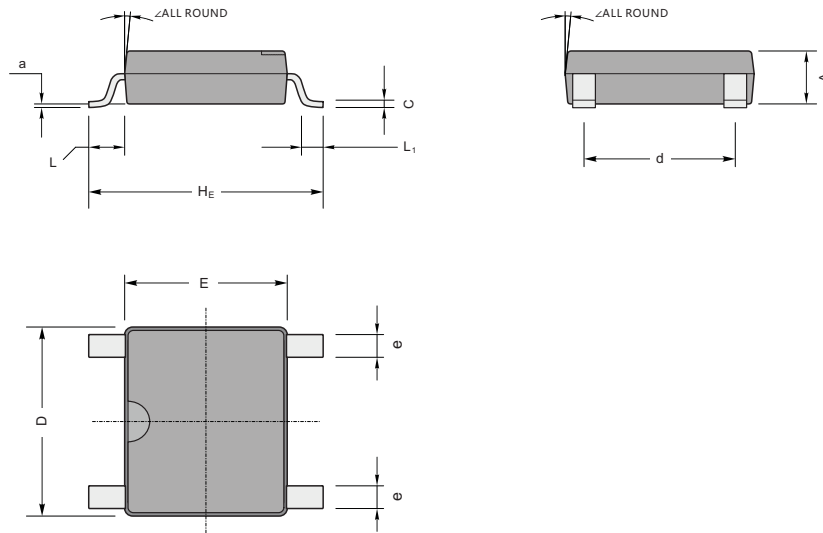

ABS/LBF mechanical data

UNIT		A	C	D	E	H <sub>E</sub>	d	e	L	L <sub>1</sub>	a	∠
mm	max	1.5	0.22	5.2	4.5	6.4	4.2	0.7	0.95	0.6	0.2	7°
	min	1.3	0.15	4.9	4.2	6.0	3.8	0.5				
mil	max	59	8.7	205	177	252	165	28	37	24	8	
	min	51	5.9	193	166	236	150	20				

### The recommended mounting pad size

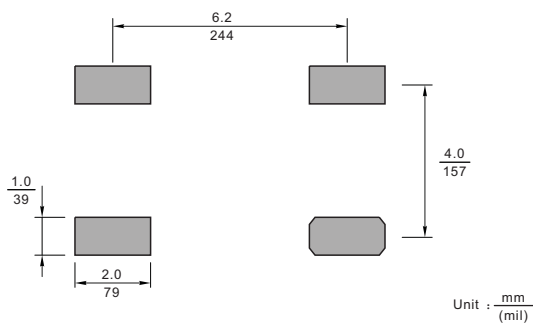

### Marking

Type number	Marking code
ABS1K	12T1
ABS2K	12T2
ABS4K	12T4
ABS6K	12T6
ABS8K	12T8
ABS10K	12T10

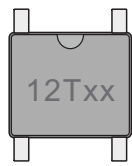

单击下面可查看定价，库存，交付和生命周期等信息

[>>SHIKUES\(时科\)](#)