

Dual Common Anode Zener TVS

(Pb) Lead(Pb)-Free

Features:

- *Allows Either Two Separate Unidirectional Configurations or a Single Bidirectional Configurations.
- *Low Leakage Current.
- *24-40 Watts Peak Power Protection.
- *Excellent Clamping Capability.
- *ESD Rating of Class N(exceeding 16KV)per the Human Body Model.
- *Transient Voltage Suppressors Encapsulated in a SOT-23 Package.

Mechanical Data:

- *Case: Molded Epoxy
- *Marking: Marking Code
- *Maximum Case Temperature for Soldering Purpose: 260 C for 10 sec.
- *Weight: 0.008grams(approx.)

**SMALL SIGNAL
ZENER DIODES
300m WATTS
3-26 VOLTS**

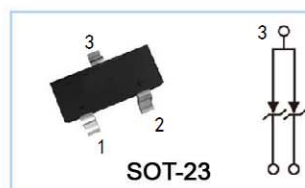

SOT-23 Outline Dimensions

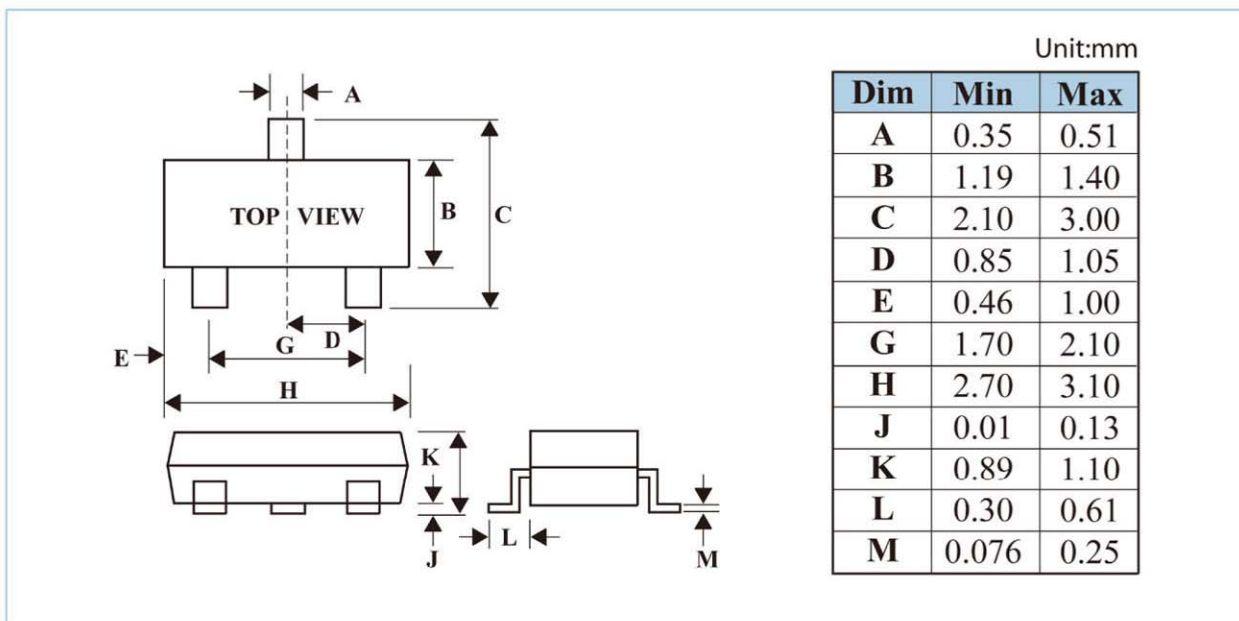

Maximum Ratings (TA=25°C Unless otherwise Noted)

Characteristics	Symbol	Value	
Peak Power Dissipation @ 1.0 ms @ $T_L \leq 25^\circ\text{C}$ ⁽¹⁾ MMBZ5V6A thru MMBZ10VA MMBZ12VA thru MMBZ33VA	P_{PK}	24 40	W
Total Power Dissipation on FR-5 Board ⁽²⁾ @ $T_A=25^\circ\text{C}$ Derate above 25°C Thermal Resistance Junction-to-Ambient	P_D $R_{\theta JA}$	225 1.8 556	mW mW/ $^\circ\text{C}$ $^\circ\text{C}/\text{W}$
Total Power Dissipation on Alumina Substrate ⁽³⁾ @ $T_A=25^\circ\text{C}$ Derate above 25°C Thermal Resistance Junction-to-Ambient	P_D $R_{\theta JA}$	300 2.4 417	mW mW/ $^\circ\text{C}$ $^\circ\text{C}/\text{W}$
Junction and Storage Temperature Range	T_J, T_{STG}	-55 to +150	$^\circ\text{C}$
Lead Solder Temperature-Maximum(10 Second Duration)	T_L	260	$^\circ\text{C}$

NOTE: 1. Non-Repetitive Current Pulse, per FIG 5 and Derated above $T_A=25^\circ\text{C}$ per FIG 6.

2. FR-5=1.0×0.75×0.62 in.

3. Alumina=0.4×0.3×0.024m, 99.5% alumina

Electrical Characteristics

($T_A=25^\circ\text{C}$ unless otherwise noted)

UNIDIRECTIONAL (Circuit tied to Pins 1 and 3 or 2 and 3)

Symbol	Parameter
I_{PP}	Maximum Reverse Peak Pulse Current
V_C	Clamping Voltage @ I_{PP}
V_{RWM}	Working Peak Reverse Voltage
I_R	Maximum Reverse Leakage Current @ V_{RWM}
θV_{BR}	Breakdown Voltage @ I_T
I_T	Test Current
V_{BR}	Maximum Temperature Coefficient of V_{BR}
I_F	Forward Current
V_F	Forward Voltage @ I_F
Z_{ZT}	Maximum Zener Impedance @ I_{ZT}
I_{ZK}	Reverse Current
Z_{ZK}	Maximum Zener Impedance @ I_{ZK}

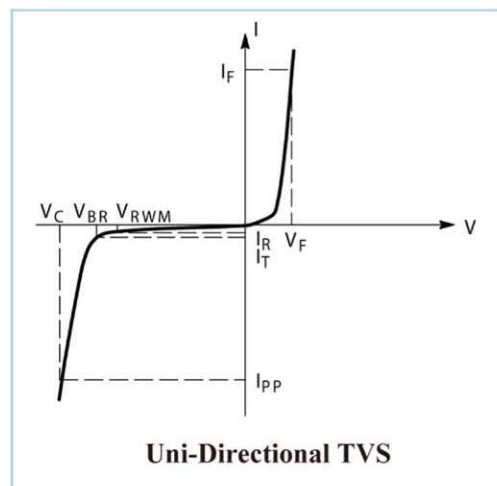

Device Marking

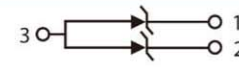
Item	Marking	Equivalent Circuit diagram
MMBZ5V6A Series	XX=Specific Device Code (See Table on Page 3)	

ELECTRICAL CHARACTERISTICS ($T_A = 25^\circ\text{C}$ unless otherwise noted)

UNIDIRECTIONAL (Circuit tied to Pins 1 and 3 or Pins 2 and 3)

($V_F = 0.9\text{ V Max @ } I_F = 10\text{ mA}$)

24 WATTS

Device	Device Marking	V_{RWM} Volts	$I_R @ V_{RWM}$ uA	Breakdown Voltage			@ I_T mA	Max Zener Impedance ⁽⁵⁾			$V_C @ I_{PP}$ ⁽⁶⁾		θV_{BR} mV/°C
				$V_{BR}^{(4)}$ (V)				Z_{ZT} @ I_{ZT}	Z_{ZK} @ I_{ZK}	V_C	I_{PP}		
				Min	Nom	Max		Ω	Ω	V	A		
MMBZ5V6A	5A6	3.0	5.0	5.32	5.6	5.88	20	11	1600	0.25	8.0	3.0	1.26
MMBZ6V2A	6A2	3.0	0.5	5.89	6.2	6.51	1.0	-	-	-	8.7	2.76	2.80
MMBZ6V8A	6A8	4.5	0.5	6.46	6.8	7.14	1.0	-	-	-	9.6	2.5	3.4
MMBZ9V1A	9A1	6.0	0.3	8.65	9.1	9.56	1.0	-	-	-	14	1.7	7.5
MMBZ10VA	10A	6.5	0.3	9.50	10	10.5	1.0	-	-	-	14.2	1.7	7.5

($V_F = 0.9\text{ V Max @ } I_F = 10\text{ mA}$)

40 WATTS

Device	Device Marking	V_{RWM} Volts	$I_R @ V_{RWM}$ nA	Breakdown Voltage			@ I_T mA	$V_C @ I_{PP}^{(6)}$		θV_{BR} mV/°C
				$V_{BR}^{(4)}$ (V)				V_C	I_{PP}	
				Min	Nom	Max		V	A	
MMBZ12VA	12A	8.5	200	11.40	12	12.60	1.0	17	2.35	7.5
MMBZ15VA	15A	12	50	14.25	15	15.75	1.0	21	1.9	12.3
MMBZ18VA	18A	14.5	50	17.10	18	18.90	1.0	25	1.6	15.3
MMBZ20VA	20A	17	50	19.00	20	21.00	1.0	28	1.4	17.2
MMBZ27VA	27A	22	50	25.65	27	28.35	1.0	40	1.0	24.3
MMBZ33VA	33A	26	50	31.35	33	34.65	1.0	46	0.87	30.4

4. V_{BR} measured at pulse test current I_T at an ambient temperature of 25°C .

5. Z_{ZT} and Z_{ZK} are measured by dividing the AC voltage drop across the device by the AC current applied. The specified limits are for $I_{Z(AC)} = 0.1 I_{Z(DC)}$, with the AC frequency = 1.0 kHz.

6. Surge current waveform per Fig 5 and derate per Fig 6

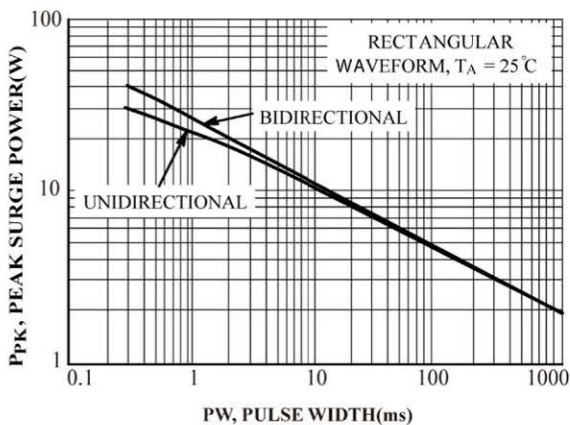

FIG.7 Maximum Non-repetitive Surge Power, P_{PK} Versus PW

Power is defined as $V_{RSM} \times I_{Z(pk)}$ where V_{RSM} is the clamping voltage at $I_{Z(pk)}$.

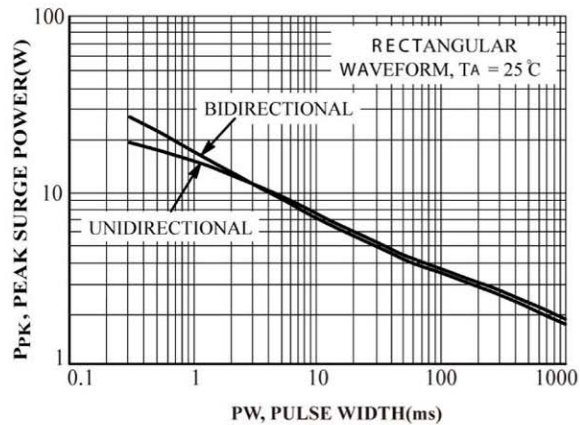

FIG.8 Maximum Non-repetitive Surge Power, P_{PK} (NOM) Versus PW

Power is defined as $V_Z(\text{NOM}) \times I_{Z(pk)}$ where $V_Z(\text{NOM})$ is the nominal Zener voltage measured at the low test current used for voltage classification

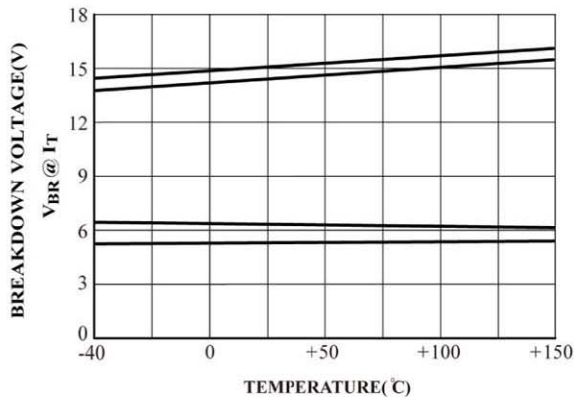

FIG.1 Typical Breakdown Voltage Versus Temperature

(Upper curve for each voltage is bidirectional mode,
lower curve is unidirectional mode)

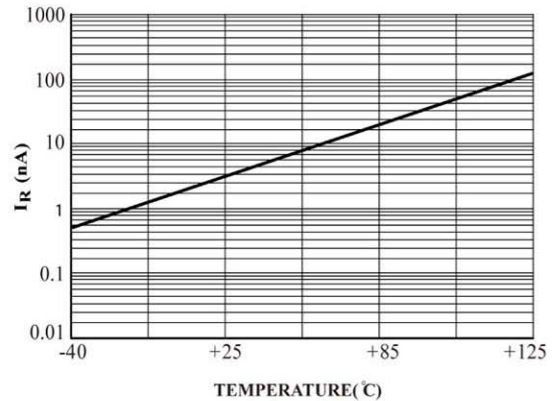

FIG.2 Typical Leakage Current Versus Temperature

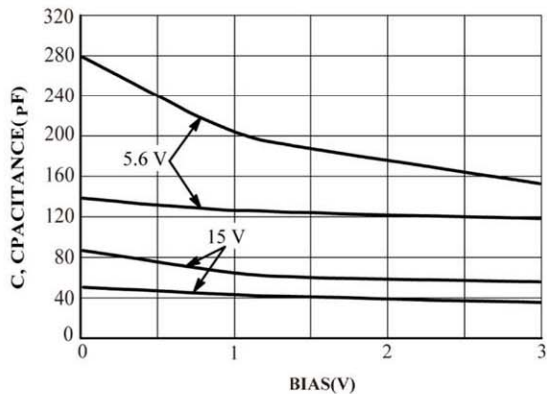

FIG.3 Typical Capacitance Versus Bias Voltage

(Upper curve for each voltage is bidirectional mode,
lower curve is unidirectional mode)

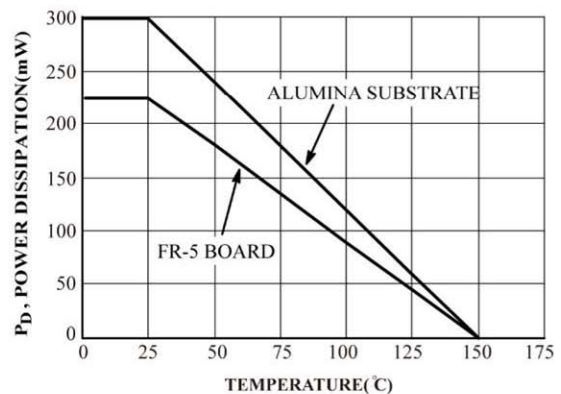

FIG.4 Steady State Power Derating Curve

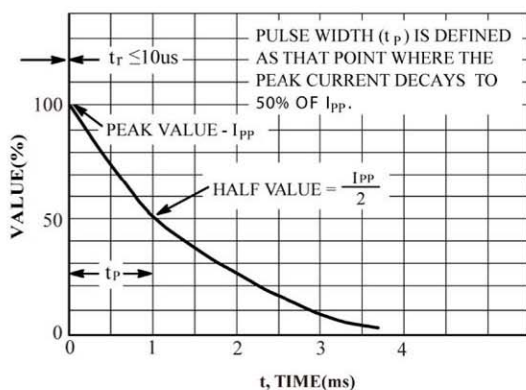

FIG.5 Pulse Waveform

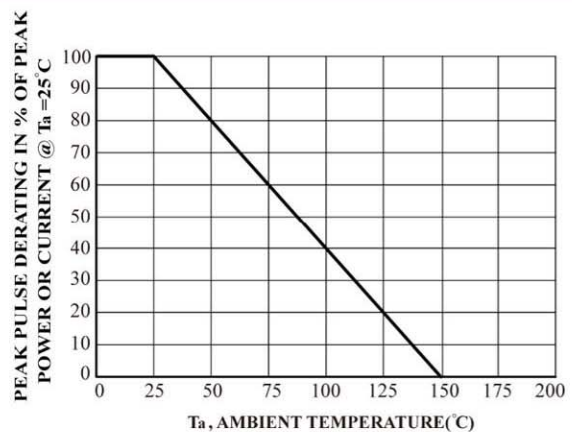

FIG.6 Pulse Derating Curve

单击下面可查看定价，库存，交付和生命周期等信息

[>>SHIKUES\(时科\)](#)