

• Features

- High collector current
- 1.3 W power dissipation.

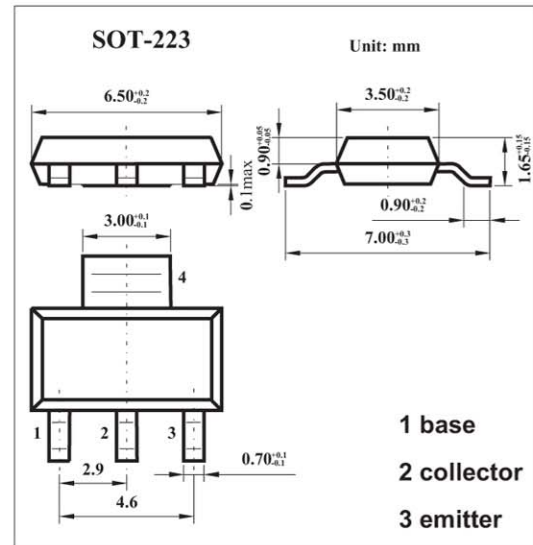

• Absolute Maximum Ratings Ta = 25°C

Parameter	Symbol	Rating	Unit
collector-base voltage	V _{CBO}	45	V
		60	V
		100	V
collector-emitter voltage	V _{CEO}	45	V
		60	V
		80	V
emitter-base voltage	V _{EB0}	5	V
collector current (DC)	I _C	1	A
peak collector current	I _{CM}	1.5	A
peak base current	I _{BM}	0.2	A
total power dissipation	P _{tot}	1.33	W
storage temperature	T _{stg}	-65 to +150	°C
junction temperature	T _j	150	°C
operating ambient temperature	T _{amb}	-65 to +150	°C
thermal resistance from junction to ambient	R _{th j-a}	94	K/W
thermal resistance from junction to soldering point	R _{th j-s}	13	K/W

● Electrical Characteristics Ta = 25°C

Parameter	Symbol	Testconditions	Min	Typ	Max	Unit
collector cut-off current	I _{CBO}	I _E = 0 A; V _{CB} = 30 V			100	nA
		I _E = 0 A; V _{CB} = 30 V; T _j = 150 °C			10	μA
emitter cut-off current	I _{EBO}	I _C = 0 A; V _{EB} = 5 V			100	nA
DC current gain	h _{FE}	I _C = 5 mA; V _{CE} = 2 V	63			
		I _C = 150 mA; V _{CE} = 2 V	63		250	
		I _C = 500 mA; V _{CE} = 2 V	40			
DC current gain BCP54; BCP55; BCP56 BCP54-10; BCP55-10; BCP56-10 BCP54-16; BCP55-16; BCP56-16	h _{FE}	V _{CE} = 2 V; I _C = 150 mA	63		250	
			63		160	
			100		250	
collector-emitter saturation voltage	V _{CEsat}	I _C = 0.5 A; I _B = 50 mA			500	mV
base-emitter voltage	V _{BE}	I _C = 0.5 A; V _{CE} = 2 V			1	V
transition frequency	f _T	I _C = 10 mA; V _{CE} = 5 V; f = 100 MHz		130		MHz
DC current gain ratio of the complementary pairs	$\frac{h_{FE1}}{h_{FE2}}$	I _C = 150 mA; V _{CE} = 2 V			1.6	

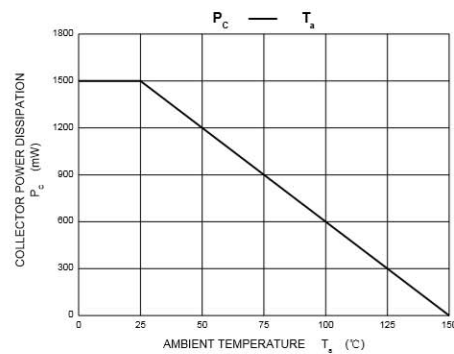
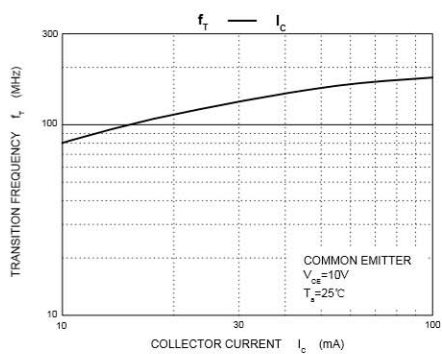
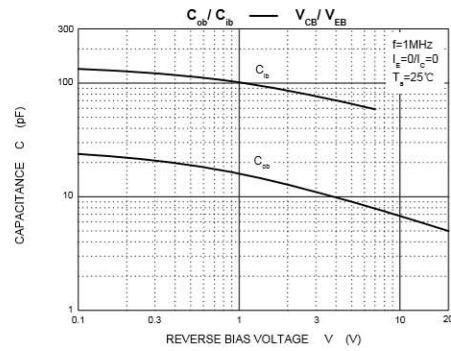
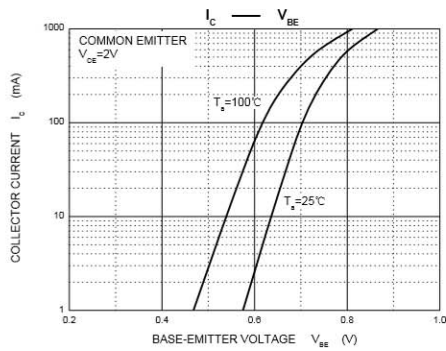
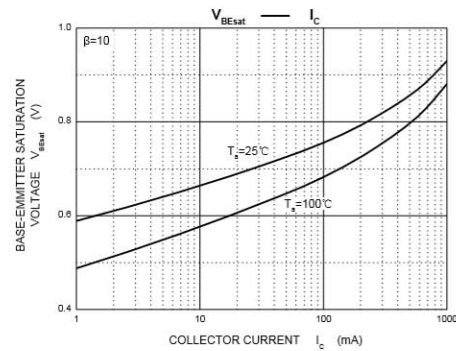
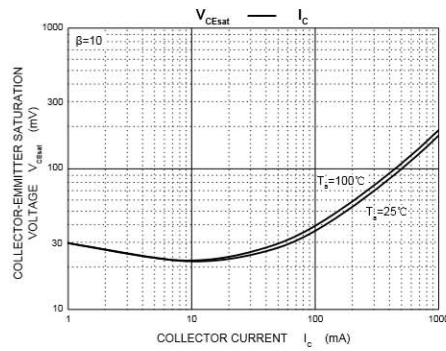
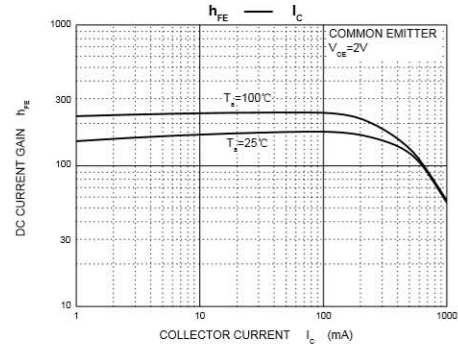
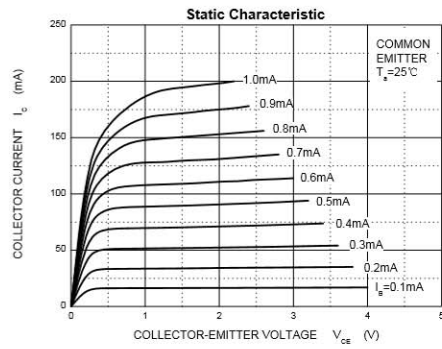

单击下面可查看定价，库存，交付和生命周期等信息

[>>SHIKUES\(时科\)](#)