

Surface Mount Superfast Recovery Rectifier

Reverse Voltage – 50 to 600 V Forward Current –3 A

FEATURES

- For surface mounted applications
- Low profile package
- Glass Passivated Chip Junction
- Superfast reverse recovery time
- Lead free in comply with EU RoHS 2011/65/EU directives

MECHANICAL DATA

- Case : SMC
- Terminals: Solderable per MIL-STD-750, Method 2026
- Approx. Weight : 0.22g / 0.0077oz

PINNING

| PIN | DESCRIPTION |
|-----|-------------|
| 1 | Cathode |
| 2 | Anode |

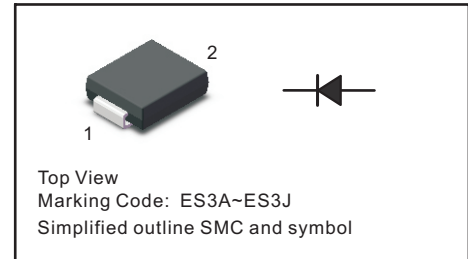

Absolute Maximum Ratings and Characteristics

Ratings at 25 °C ambient temperature unless otherwise specified. Single phase, half wave, 60 Hz, resistive or inductive load. For capacitive load, derate current by 20%.

| Parameter | Symbols | ES3AC G | ES3BC G | ES3CC G | ES3DC G | ES3EC G | ES3GC G | ES3JC G | Units |
|--|------------------------------------|------------|------------|------------|------------|------------|------------|------------|----------------------|
| Maximum Repetitive Peak Reverse Voltage | V_{RRM} | 50 | 100 | 150 | 200 | 300 | 400 | 600 | V |
| Maximum RMS voltage | V_{RMS} | 35 | 70 | 105 | 140 | 210 | 280 | 420 | V |
| Maximum DC Blocking Voltage | V_{DC} | 50 | 100 | 150 | 200 | 300 | 400 | 600 | V |
| Maximum Average Forward Rectified Current at $T_c = 125\text{ °C}$ | $I_{F(AV)}$ | 3 | | | | | | | A |
| Peak Forward Surge Current 8.3 ms Single Half Sine Wave Superimposed on Rated Load | I_{FSM} | 90 | | | | | | | A |
| Maximum Forward Voltage at 3 A | V_F | 1 | | | | 1.25 | | 1.68 | V |
| Maximum DC Reverse Current at Rated DC Blocking Voltage $T_a = 25\text{ °C}$ $T_a = 125\text{ °C}$ | I_R | 5 100 | | | | | | | μA |
| Typical Junction Capacitance at $V_R=4\text{V}$, $f=1\text{MHz}$ | C_j | 40 | | | | | | | pF |
| Maximum Reverse Recovery Time ⁽¹⁾ | t_{rr} | 35 | | | | | | | ns |
| Typical Thermal Resistance ⁽²⁾ | $R_{\theta JA}$ $R_{\theta JC}$ | 40 16 | | | | | | | $^{\circ}\text{C/W}$ |
| Operating and Storage Temperature Range | T_j, T_{stg} | -55 ~ +150 | | | | | | | $^{\circ}\text{C}$ |

(1) Measured with $I_F = 0.5\text{ A}$, $I_R = 1\text{ A}$, $I_{rr} = 0.25\text{ A}$.

(2) P.C.B. mounted with 2.0" X 2.0" (5 X 5 cm) copper pad areas.

Fig.1 Reverse Recovery Time Characteristic And Test Circuit Diagram

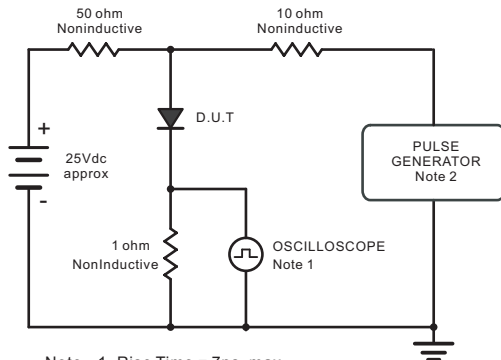

Note: 1. Rise Time = 7ns, max.
Input Impedance = 1 megohm, 22pF.
2. Rise Time = 10ns, max.
Source Impedance = 50 ohms.

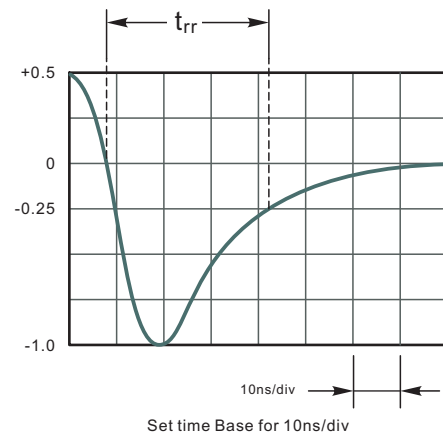

Fig.2 Maximum Average Forward Current Rating

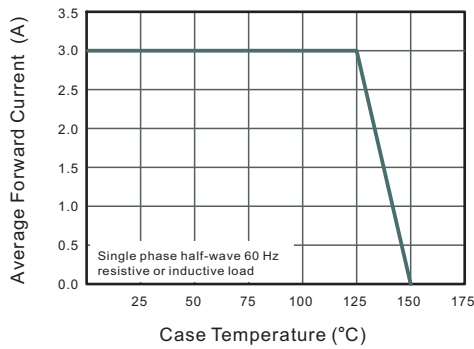

Fig.3 Typical Reverse Characteristics

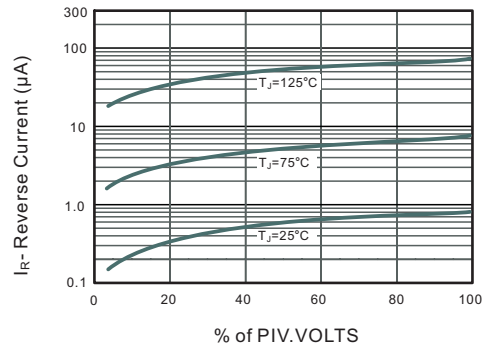

Fig.4 Typical Forward Characteristics

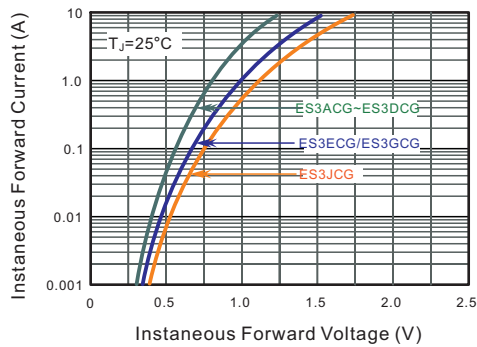

Fig.5 Typical Junction Capacitance

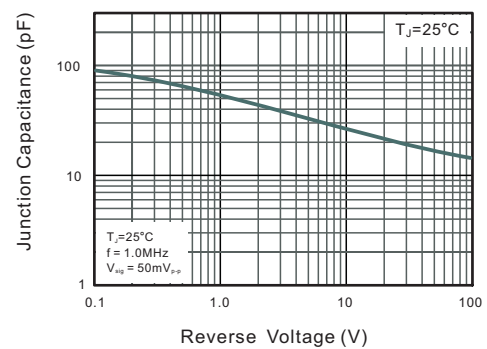
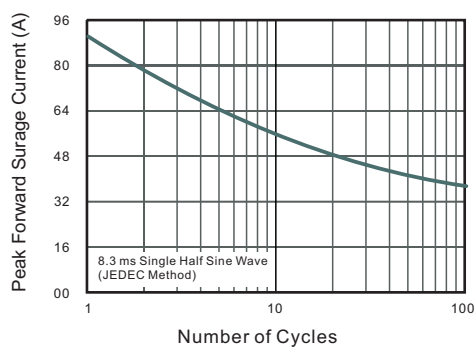

Fig.6 Maximum Non-Repetitive Peak Forward Surge Current



PACKAGE OUTLINE

Plastic surface mounted package; 2 leads

SMC

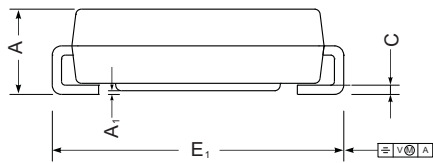
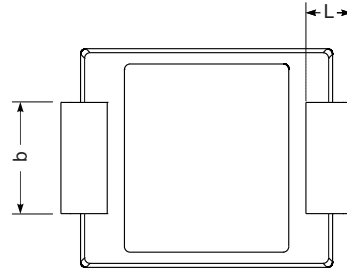
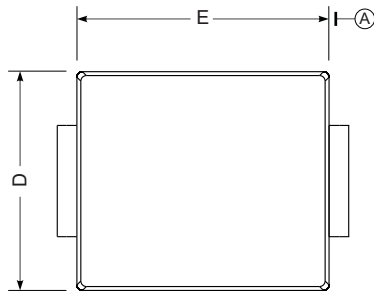

SMC mechanical data

| UNIT | | A | E | D | E ₁ | A ₁ | C | L | b |
|------|-----|------|-----|-----|----------------|----------------|------|-----|------|
| mm | max | 2.62 | 7.0 | 6.2 | 8.0 | 0.21 | 0.31 | 1.6 | 3.25 |
| | min | 2.00 | 6.5 | 5.6 | 7.6 | 0.05 | 0.15 | 0.9 | 2.75 |
| mil | max | 103 | 276 | 244 | 315 | 8.3 | 12 | 63 | 128 |
| | min | 79 | 256 | 220 | 299 | 2.0 | 5.9 | 35 | 108 |

The recommended mounting pad size

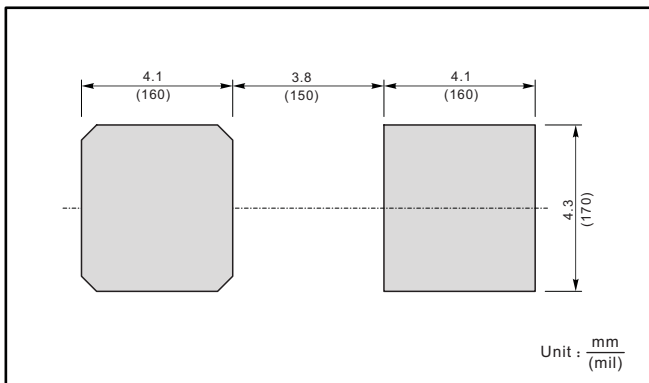

Marking

| Type number | Marking code |
|-------------|--------------|
| ES3ACG | ES3A |
| ES3BCG | ES3B |
| ES3CCG | ES3C |
| ES3DCG | ES3D |
| ES3ECG | ES3E |
| ES3GCG | ES3G |
| ES3JCG | ES3J |

单击下面可查看定价，库存，交付和生命周期等信息

[>>SHIKUES\(时科\)](#)