

Surface mount transient voltage suppressor power 200 watts

Stand-Off Voltage : 5.0V~220V

FEATURES

- For surface mounted applications in order to optimize board space.
- Low profile package
- Glass passivated junction
- Low inductance
- Plastic package has Underwriters Laboratory Flammability

MECHANICAL DATA

- Case: SOD-123FL
- Terminals: Solderable per MIL-STD-750, Method 2026
- Approx. Weight: 15mg 0.00048oz

PINNING

PIN	DESCRIPTION
1	Cathode
2	Anode

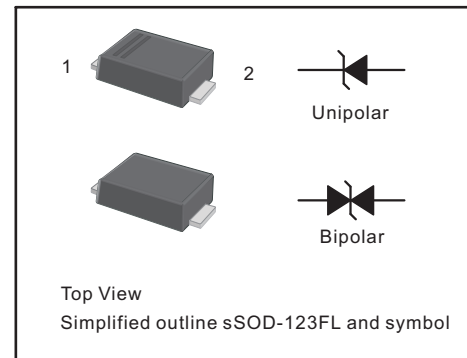

Maximum Ratings and Electrical characteristics

Ratings at 25 °C ambient temperature unless otherwise specified.

Parameter	Symbol	Value	Unit
Peak Pulse Power Dissipation on TA=25°C (Note 1,2,5, Fig1)	P_{PPM}	200	W
Peak Forward Surge Current (Note 3)	I_{FSM} (UNI)	20	A
Peak Pulse Current on 10/1000 us waveform (Note 1) Fig 2	I_{PPM}	see Table 1	A
Steady State Power Dissipation (Note 4)	$P_{M(AV)}$	1	W
Operating Junction and Storage Range	T_J, T_{STG}	-55 to +150	°C
Typical Thermal Resistance	$R_{\theta JA}$	180	°C

NOTES

1. Non-repetitive current pulse per Fig 3 and derated above $T_A=25^\circ\text{C}$ per Fig 2
2. Mounted on 5mm² copper pads to each terminal
3. 8.3ms single half sinewave, or equivalent square wave duty cycle=4 pulses per minutes maximum
4. lead temperature at $T_L=75^\circ\text{C}$
5. Peak pulse powe. waveform is $t_p=10/1000\mu\text{s}$
6. A transient suppressor is selected according to the working peak reverse voltage(V_{RWM}), Which Should be equal to or greater than the DC or continuous peak operating voltage level

Type		Marking		V _{RWM}	Breakdown Voltage		Test Current	Reverse Leakage	Max. Clamp Voltage	Peak Pulse Current
					V _{BR} @ I _T					
					Min	Max	I _T	I _R @ V _{RWM}	V _C @ I _{PP}	I _{PP}
Uni	Bi	Uni	Bi	V	V	V	mA	µA	V	A
SMF5.0A	SMF5.0CA	KE	CAE	5	6.4	7	10	400	9.2	21.7
SMF6.0A	SMF6.0CA	KG	CAG	6	6.67	7.37	10	400	10.3	19.4
SMF6.5A	SMF6.5CA	AK	CAK	6.5	7.22	7.98	10	250	11.2	17.9
SMF7.0A	SMF7.0CA	AM	CAM	7	7.78	8.6	10	100	12	16.7
SMF7.5A	SMF7.5CA	AP	CAP	7.5	8.33	9.21	1	50	12.9	15.5
SMF8.0A	SMF8.0CA	AR	CAR	8	8.89	9.83	1	25	13.6	14.7
SMF8.5A	SMF8.5CA	AT	CAT	8.5	9.44	10.4	1	10	14.4	13.9
SMF9.0A	SMF9.0CA	AV	CAV	9	10	11.1	1	5	15.4	13
SMF10A	SMF10CA	AX	CAX	10	11.1	12.3	1	2.5	17	11.8
SMF11A	SMF11CA	AZ	CAZ	11	12.2	13.5	1	2.5	18.2	11
SMF12A	SMF12CA	BE	CBE	12	13.3	14.7	1	2.5	19.9	10.1
SMF13A	SMF13CA	BG	CBG	13	14.4	15.9	1	1	21.5	9.3
SMF14A	SMF14CA	BK	CBK	14	15.6	17.2	1	1	23.2	8.6
SMF15A	SMF15CA	BM	CBM	15	16.7	18.5	1	1	24.4	8.2
SMF16A	SMF16CA	BP	CBP	16	17.8	19.7	1	1	26	7.7
SMF17A	SMF17CA	BR	CBR	17	18.9	20.9	1	1	27.6	7.2
SMF18A	SMF18CA	BT	CBT	18	20	22.1	1	1	29.2	6.8
SMF20A	SMF20CA	BV	CBV	20	22.2	24.5	1	1	32.4	6.2
SMF22A	SMF22CA	BX	CBX	22	24.4	26.9	1	1	35.5	5.6
SMF24A	SMF24CA	BZ	CBZ	24	26.7	29.5	1	1	38.9	5.1
SMF26A	SMF26CA	CE	CCE	26	28.9	31.9	1	1	42.1	4.8
SMF28A	SMF28CA	CG	CCG	28	31.1	34.4	1	1	45.4	4.4
SMF30A	SMF30CA	CK	CCK	30	33.3	36.8	1	1	48.4	4.1
SMF33A	SMF33CA	CM	CCM	33	36.7	40.6	1	1	53.3	3.8
SMF36A	SMF36CA	CP	CCP	36	40	44.2	1	1	58.1	3.4
SMF40A	SMF40CA	CR	CCR	40	44.4	49.1	1	1	64.5	3.1
SMF43A	SMF43CA	CT	CCT	43	47.8	52.8	1	1	69.4	2.9
SMF45A	SMF45CA	CV	CCV	45	50	55.3	1	1	72.7	2.8
SMF48A	SMF48CA	CX	CCX	48	53.3	58.9	1	1	77.4	2.6
SMF51A	SMF51CA	CZ	CCZ	51	56.7	62.7	1	1	82.4	2.4
SMF54A	SMF54CA	DE	CDE	54	60	66.3	1	1	87.1	2.3
SMF58A	SMF58CA	DG	CDG	58	64.4	71.2	1	1	93.6	2.1
SMF60A	SMF60CA	DK	CDK	60	66.7	73.7	1	1	96.8	1.8
SMF64A	SMF64CA	DM	CDM	64	71.1	78.6	1	1	103	1.7
SMF70A	SMF70CA	DP	CDP	70	77.8	86	1	1	113	1.5
SMF75A	SMF75CA	DR	CDR	75	83.3	92.1	1	1	121	1.4
SMF78A	SMF78CA	DT	CDT	78	86.7	95.8	1	1	126	1.4
SMF85A	SMF85CA	DV	CDV	85	94.4	104	1	1	137	1.3
SMF90A	SMF90CA	DX	CDX	90	100	111	1	1	146	1.2
SMF100A	SMF100CA	DZ	CDZ	100	111	123	1	1	162	1.1
SMF110A	SMF110CA	EE	CEE	110	122	135	1	1	177	1
SMF120A	SMF120CA	EG	CEG	120	133	147	1	1	193	0.9
SMF130A	SMF130CA	EK	CEK	130	144	159	1	1	209	0.8
SMF150A	SMF150CA	EM	CEM	150	167	185	1	1	243	0.7
SMF160A	SMF160CA	EP	CEP	160	178	197	1	1	259	0.7
SMF170A	SMF170CA	ER	CER	170	189	209	1	1	275	0.6
SMF180A	SMF180CA	ET	CET	180	201	222	1	1	292	0.5
SMF200A	SMF200CA	EX	CEX	200	224	247	1	1	324	0.5
SMF220A	SMF220CA	E22	CE22	220	246	272	1	1	356	0.5

Fig.1 Peak Pulse Power Rating Curve

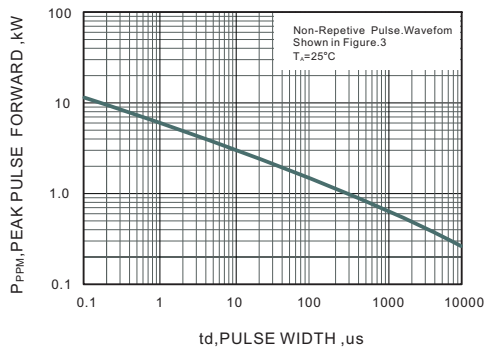

Fig.2 Forward Current Derating Curve

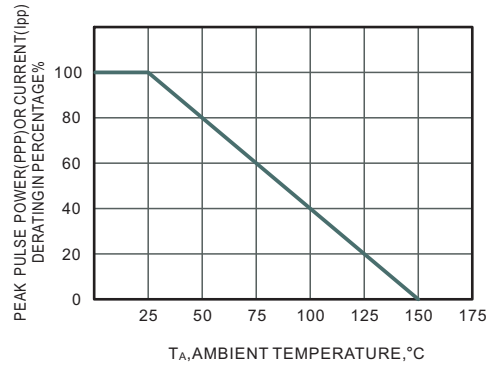

Fig.3 Pulse Waveform

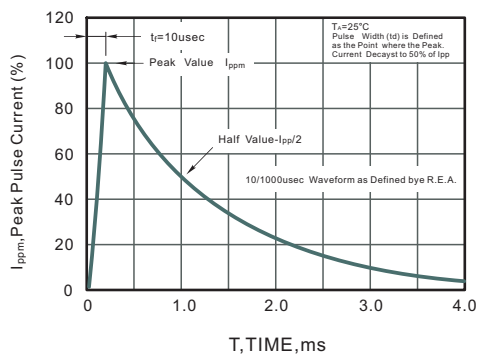
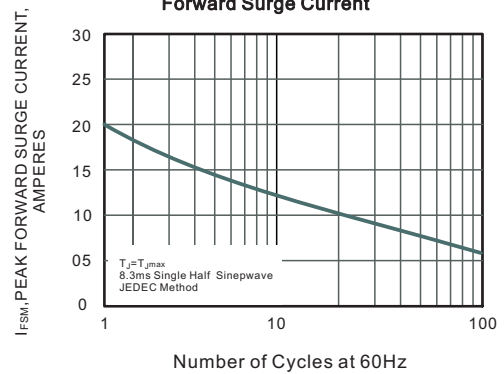

Fig.4 Maximum Non-Repetitive Peak Forward Surge Current



PACKAGE OUTLINE

Plastic surface mounted package; 2 leads

SOD-123FL

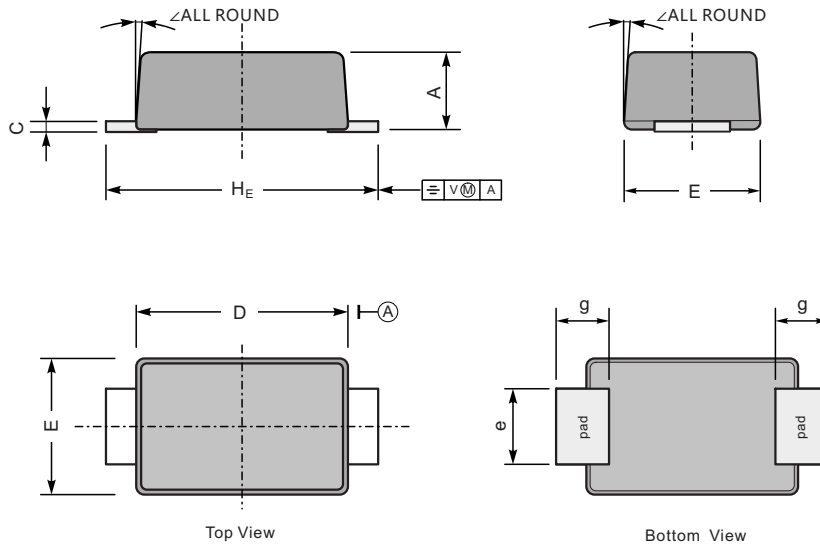

UNIT		A	C	D	E	e	g	H _E	∠
mm	max	1.1	0.20	2.9	1.9	1.1	0.9	3.8	7°
	min	0.9	0.12	2.6	1.7	0.8	0.7	3.5	
mil	max	43	7.9	114	75	43	35	150	
	min	35	4.7	102	67	31	28	138	

The recommended mounting pad size

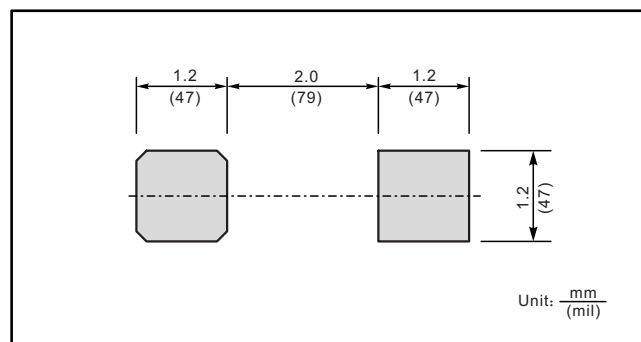

单击下面可查看定价，库存，交付和生命周期等信息

[>>SHIKUES\(时科\)](#)