

Surface Mount Superfast Recovery Rectifier
Reverse Voltage – 50 to 600 V Forward Current –5 A

FEATURES

- For surface mounted applications
- Low profile package
- Glass Passivated Chip Junction
- Superfast reverse recovery time
- Lead free in comply with EU RoHS 2011/65/EU directives

MECHANICAL DATA

- Case : SMC
- Terminals: Solderable per MIL-STD-750, Method 2026
- Approx. Weight : 0.22g / 0.0077oz

PINNING

PIN	DESCRIPTION
1	Cathode
2	Anode

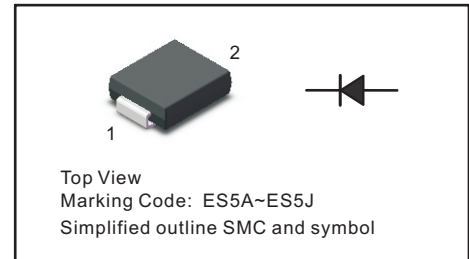

Absolute Maximum Ratings and Characteristics

Ratings at 25 °C ambient temperature unless otherwise specified. Single phase, half wave, 60 Hz, resistive or inductive load. For capacitive load, derate current by 20%.

Parameter	Symbols	ES5AC G	ES5BC G	ES5CC G	ES5DC G	ES5EC G	ES5GC G	ES5JC G	Units
Maximum Repetitive Peak Reverse Voltage	V_{RRM}	50	100	150	200	300	400	600	V
Maximum RMS voltage	V_{RMS}	35	70	105	140	210	280	420	V
Maximum DC Blocking Voltage	V_{DC}	50	100	150	200	300	400	600	V
Maximum Average Forward Rectified Current at $T_c = 100\text{ }^\circ\text{C}$	$I_{F(AV)}$	5							A
Peak Forward Surge Current 8.3 ms Single Half Sine Wave Superimposed on Rated Load	I_{FSM}	120							A
Maximum Forward Voltage at 5 A	V_F	1				1.25		1.68	V
Maximum DC Reverse Current at Rated DC Blocking Voltage $T_a = 25\text{ }^\circ\text{C}$ $T_a = 125\text{ }^\circ\text{C}$	I_R	5 100							μA
Typical Junction Capacitance at $V_R=4\text{V}$, $f=1\text{MHz}$	C_j	50							pF
Maximum Reverse Recovery Time ⁽¹⁾	t_{rr}	35							ns
Typical Thermal Resistance ⁽²⁾	$R_{\theta JA}$ $R_{\theta JC}$	35 13							$^\circ\text{C/W}$
Operating and Storage Temperature Range	T_j, T_{stg}	-55 ~ +150							$^\circ\text{C}$

(1) Measured with $I_F = 0.5\text{ A}$, $I_R = 1\text{ A}$, $I_{rr} = 0.25\text{ A}$.

(2) P.C.B. mounted with 2.0" X 2.0" (5 X 5 cm) copper pad areas.

Fig.1 Reverse Recovery Time Characteristic And Test Circuit Diagram

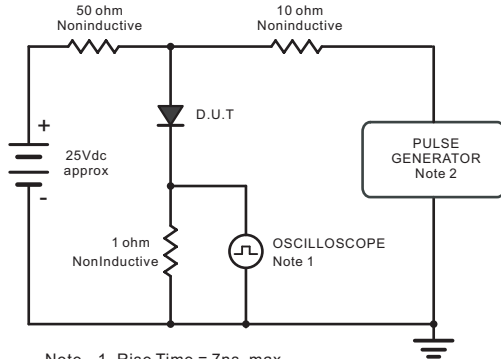

Note: 1. Rise Time = 7ns, max.
Input Impedance = 1megohm, 22pF.
2. Rise Time = 10ns, max.
Source Impedance = 50 ohms.

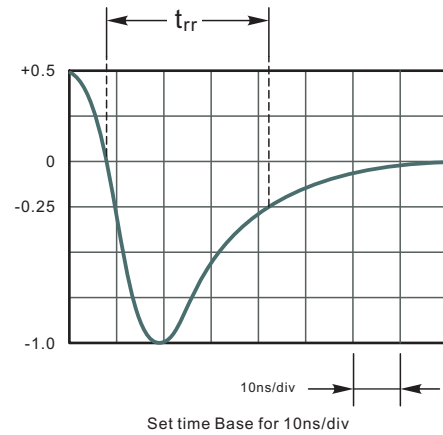

Fig.2 Maximum Average Forward Current Rating

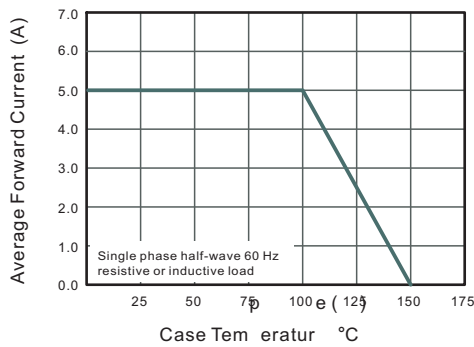

Fig.4 Typical Forward Characteristics

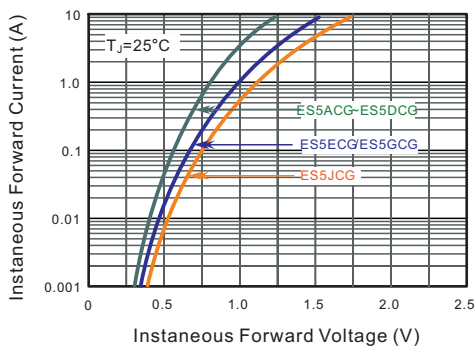

Fig.6 Maximum Non-Repetitive Peak Forward Surge Current

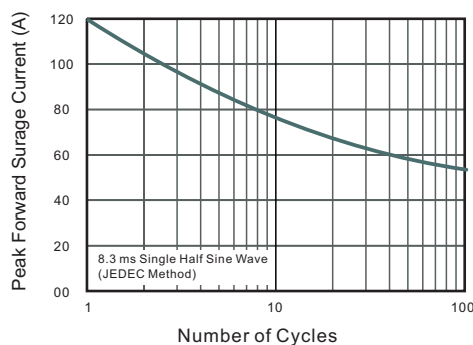

Fig.3 Typical Reverse Characteristics

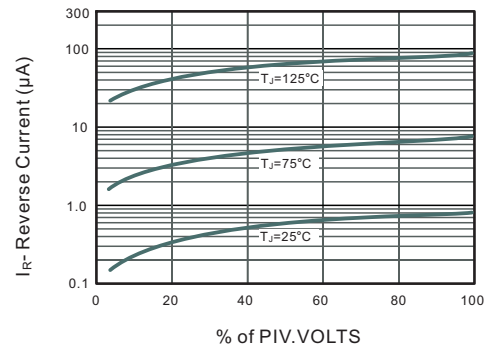
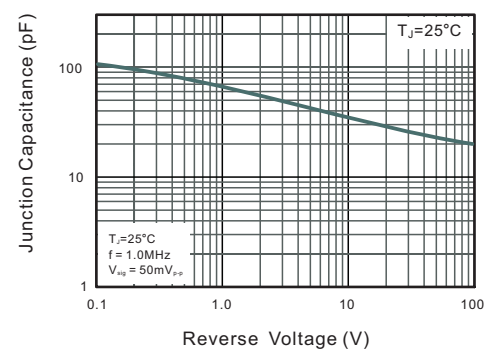

Fig.5 Typical Junction Capacitance



PACKAGE OUTLINE

Plastic surface mounted package; 2 leads

SMC

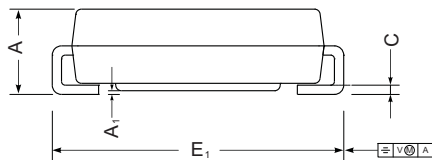
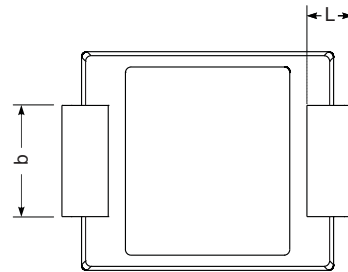
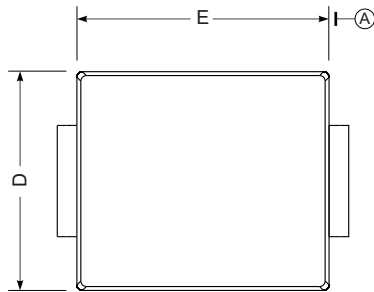

SMC mechanical data

UNIT		A	E	D	E ₁	A ₁	C	L	b
mm	max	2.62	7.0	6.2	8.0	0.21	0.31	1.6	3.25
	min	2.00	6.5	5.6	7.6	0.05	0.15	0.9	2.75
mil	max	103	276	244	315	8.3	12	63	128
	min	79	256	220	299	2.0	5.9	35	108

The recommended mounting pad size

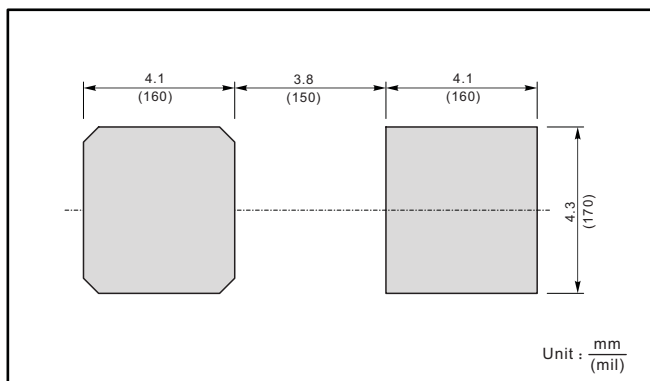

Marking

Type number	Marking code
ES5ACG	ES5A
ES5BCG	ES5B
ES5CCG	ES5C
ES5DCG	ES5D
ES5ECG	ES5E
ES5GCG	ES5G
ES5JCG	ES5J

单击下面可查看定价，库存，交付和生命周期等信息

[>>SHIKUES\(时科\)](#)