

PNP Silicon

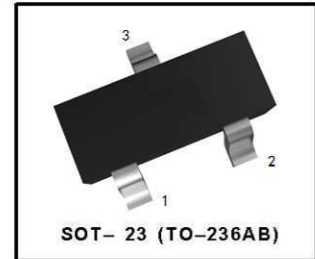
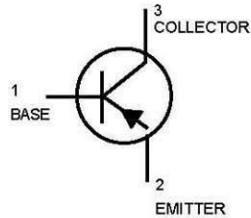

● MAXIMUM RATINGS

Rating	Symbol	Value	Unit
Collector–Emitter Voltage	V_{CE0}	– 150	Vdc
Collector–Base Voltage	V_{CBO}	– 160	Vdc
Emitter–Base Voltage	V_{EBO}	– 5.0	Vdc
Collector Current — Continuous	I_C	– 600	mAdc

● THERMAL CHARACTERISTICS

Characteristic	Symbol	Max	Unit
Total Device Dissipation FR- 5 Board (1) $T_A = 25^\circ\text{C}$ Derate above 25°C	P_D	225	mW
Thermal Resistance, Junction to Ambient	$R_{\theta JA}$	556	$^\circ\text{C/W}$
Total Device Dissipation Alumina Substrate, (2) $T_A = 25^\circ\text{C}$ Derate above 25°C	P_D	300	mW
Thermal Resistance, Junction to Ambient	$R_{\theta JA}$	417	$^\circ\text{C/W}$
Junction and Storage Temperature	T_J, T_{stg}	–55to+150	$^\circ\text{C}$

● DEVICE MARKING

MMBT5401=2L

● ELECTRICAL CHARACTERISTICS ($T_A = 25^\circ\text{C}$ unless otherwise noted)

Characteristic	Symbol	Min	Max	Unit
OFF CHARACTERISTICS				
Collector–Emitter Breakdown Voltage ($I_C = -1.0\text{ mAdc}, I_B = 0$)	$V_{(BR)CE0}$	– 150	—	Vdc
Collector–Base Breakdown Voltage ($I_C = -100\ \mu\text{Adc}, I_E = 0$)	$V_{(BR)CBO}$	– 160	—	Vdc
Emitter–Base Breakdown Voltage ($I_E = -10\ \mu\text{Adc}, I_C = 0$)	$V_{(BR)EBO}$	– 5.0	—	Vdc
Collector Cutoff Current ($V_{CB} = -120\text{ Vdc}, I_E = 0$)	I_{CES}	—	– 50	nAdc
($V_{CB} = -120\text{ Vdc}, I_E = 0, T_A = 100^\circ\text{C}$)		—	– 50	μAdc

1. FR-5 = 1.0 x 0.75 x 0.062 in.

2. Alumina = 0.4 x 0.3 x 0.024 in. 99.5% alumina.

● **ELECTRICAL CHARACTERISTICS** ($T_A = 25^\circ\text{C}$ unless otherwise noted) (Continued)

Characteristic	Symbol	Min	Max	Unit
ON CHARACTERISTICS (2)				
DC Current Gain ($I_C = -1.0\text{mA}$, $V_{CE} = -5.0\text{Vdc}$)	h_{FE}	50	—	—
($I_C = -10\text{mA}$, $V_{CE} = -5.0\text{Vdc}$)		60	240	
($I_C = -50\text{mA}$, $V_{CE} = -5.0\text{Vdc}$)		50	—	
Collector–Emitter Saturation Voltage ($I_C = -10\text{mA}$, $I_B = -1.0\text{mA}$)	$V_{CE(sat)}$	—	- 0.2	Vdc
($I_C = -50\text{mA}$, $I_B = -5.0\text{mA}$)		—	- 0.5	
Base–Emitter Saturation Voltage ($I_C = -10\text{mA}$, $I_B = -1.0\text{mA}$)	$V_{BE(sat)}$	—	- 1.0	Vdc
($I_C = -50\text{mA}$, $I_B = -5.0\text{mA}$)		—	- 1.0	

● **SMALL-SIGNAL CHARACTERISTICS**

Current–Gain — Bandwidth Product ($I_C = -10\text{mA}$, $V_{CE} = -10\text{Vdc}$, $f = 100\text{MHz}$)	f_T	100	300	MHz
Output Capacitance ($V_{CB} = -10\text{Vdc}$, $I_E = 0$, $f = 1.0\text{MHz}$)	C_{obo}	—	6.0	pF
Small–Signal Current Gain ($I_C = -1.0\text{mA}$, $V_{CE} = -10\text{Vdc}$, $f = 1.0\text{kHz}$)	h_{fe}	40	200	—
Noise Figure ($I_C = -200\mu\text{A}$, $V_{CE} = -5.0\text{Vdc}$, $R_s = 10\Omega$, $f = 1.0\text{kHz}$)	NF	—	8.0	dB

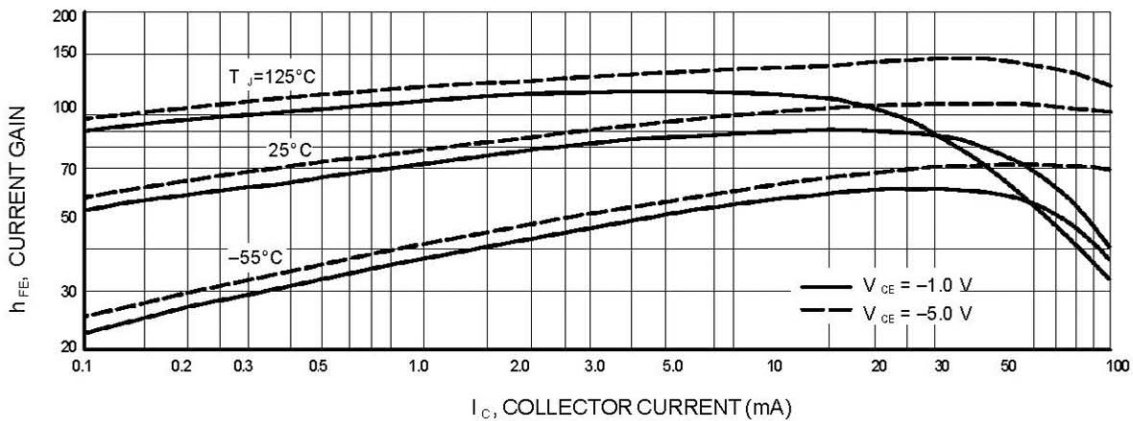

Figure 1. DC Current Gain

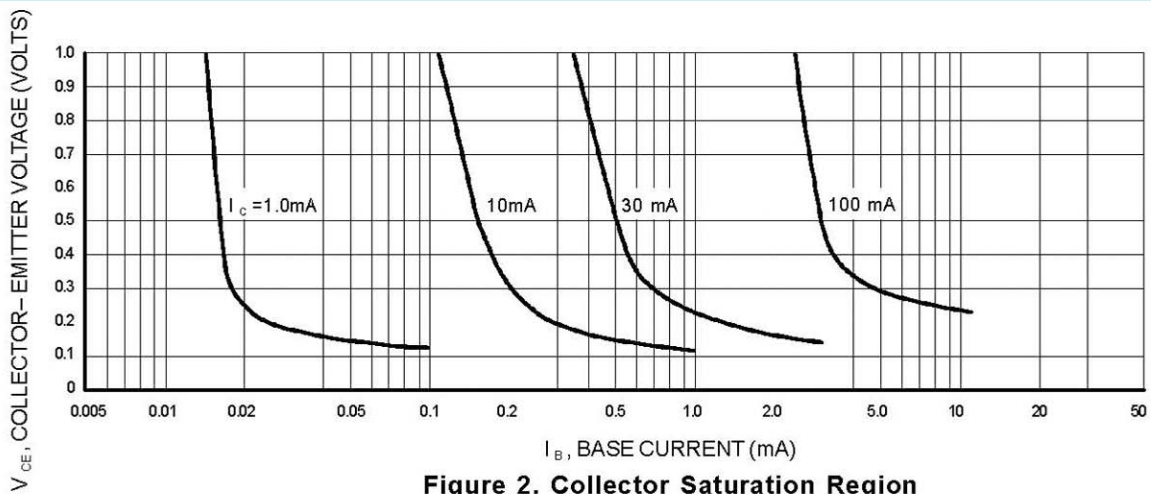

Figure 2. Collector Saturation Region

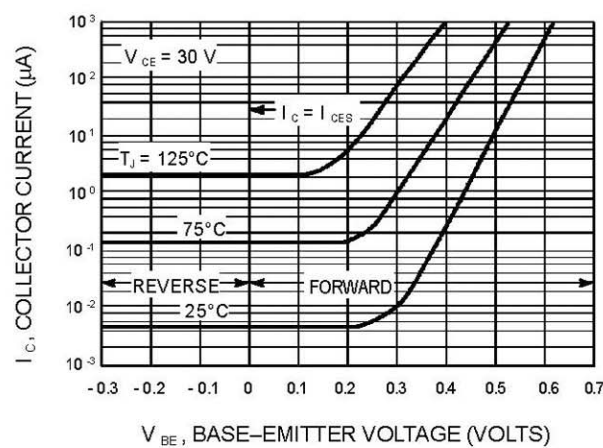
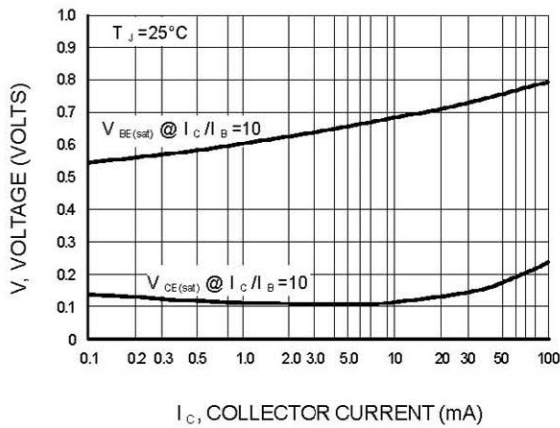
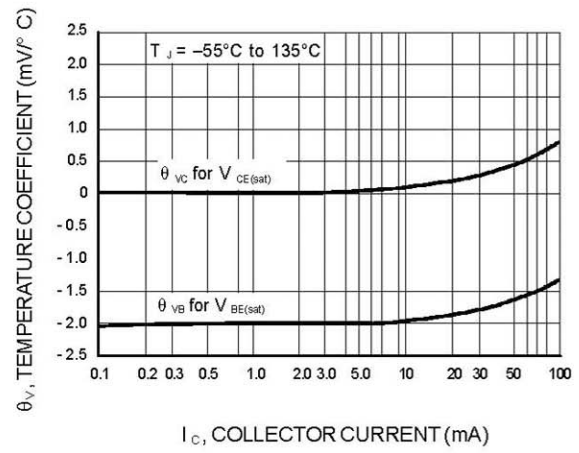

Figure 3. Collector Cut-Off Region



I_C , COLLECTOR CURRENT (mA)
Figure 4. "On" Voltages



I_C , COLLECTOR CURRENT (mA)
Figure 5. Temperature Coefficients

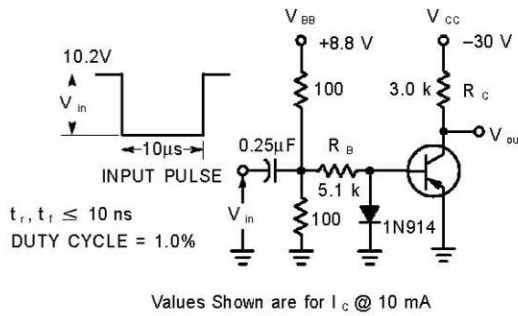

Figure 6. Switching Time Test Circuit

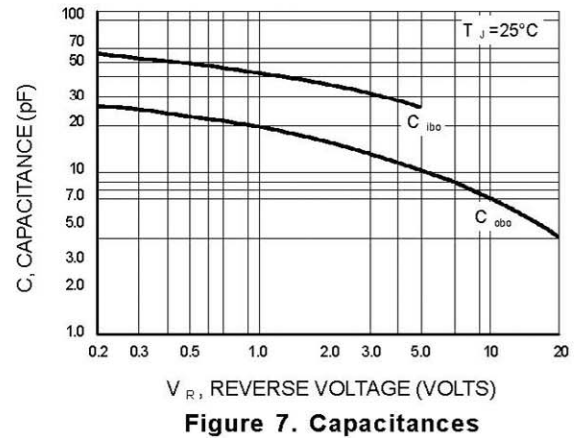
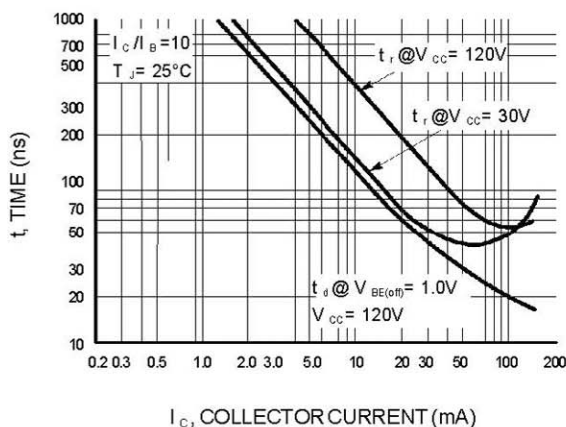
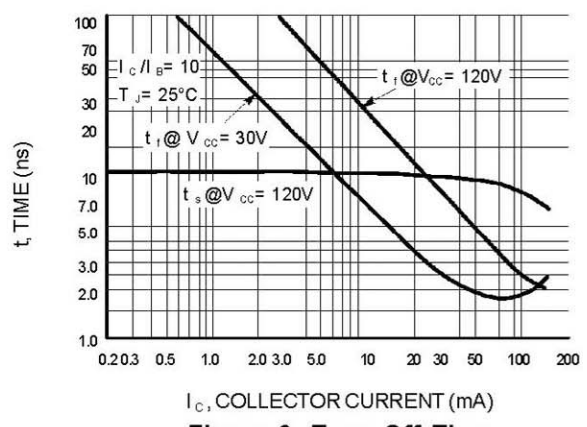

Figure 7. Capacitances



I_C , COLLECTOR CURRENT (mA)
Figure 8. Turn-On Time



I_C , COLLECTOR CURRENT (mA)
Figure 9. Turn-Off Time

单击下面可查看定价，库存，交付和生命周期等信息

[>>SHIKUES\(时科\)](#)