

Surface Mount Fast Recovery Rectifiers

Reverse Voltage - 50 to 1000 V

Forward Current - 2 A

FEATURES

- For surface mounted applications
- Low profile package
- Glass Passivated Chip Junction
- Easy to pick and place
- Fast reverse recovery time
- Lead free in comply with EU RoHS 2011/65/EU directives

MECHANICAL DATA

- Case: SMAF
- Terminals: Solderable per MIL-STD-750, Method 2026
- Approx. Weight: 27mg 0.00086oz

PINNING

PIN	DESCRIPTION
1	Cathode
2	Anode

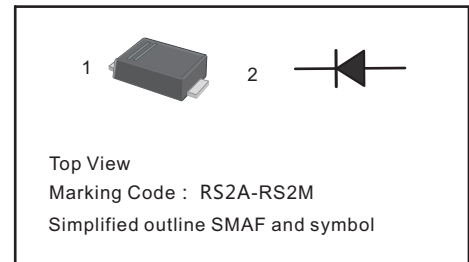

Maximum Ratings and Electrical characteristics

Ratings at 25 °C ambient temperature unless otherwise specified. Single phase half-wave 60 Hz, resistive or inductive load for capacitive load current derate by 20 %.

Parameter	Symbols	RS2AF	RS2BF	RS2DF	RS2GF	RS2JF	RS2KF	RS2MF	Units
Maximum Repetitive Peak Reverse Voltage	V_{RRM}	50	100	200	400	600	800	1000	V
Maximum RMS voltage	V_{RMS}	35	70	140	280	420	560	700	V
Maximum DC Blocking Voltage	V_{DC}	50	100	200	400	600	800	1000	V
Maximum Average Forward Rectified Current at $T_a = 65\text{ °C}$	$I_{F(AV)}$	2							A
Peak Forward Surge Current 8.3 ms Single Half Sine Wave Superimposed on Rated Load (JEDEC Method)	I_{FSM}	50							A
Maximum Instantaneous Forward Voltage at 2 A	V_F	1.3							V
Maximum DC Reverse Current at Rated DC Blocking Voltage $T_a = 25\text{ °C}$ $T_a = 125\text{ °C}$	I_R	5 100							μA
Maximum Reverse Recovery Time ¹⁾	t_{rr}	150				250	500		ns
Typical Junction Capacitance ²⁾	C_j	22							pF
Operating and Storage Temperature Range	T_j, T_{stg}	-55 ~ +150							°C

1) Measured with $I_F = 0.5\text{ A}$, $I_R = 1\text{ A}$, $I_{rr} = 0.25\text{ A}$

2) Measured at 1MHz and applied reverse voltage of 4V D.C

Fig.1 Forward Current Derating Curve

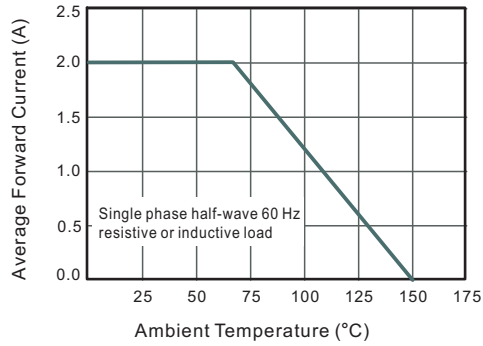

Fig.2 Typical Reverse Characteristics

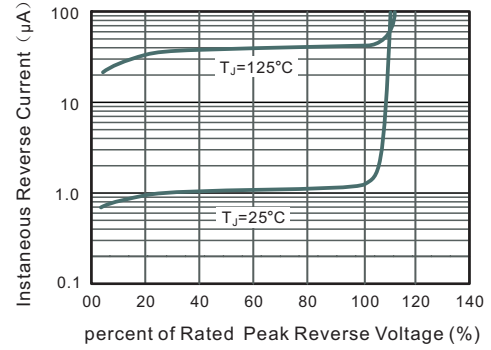

Fig.3 Typical Instantaneous Forward Characteristics

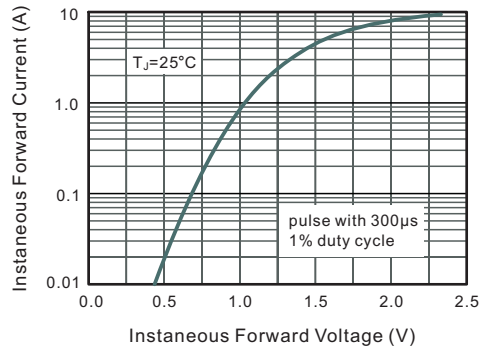

Fig.4 Typical Junction Capacitance

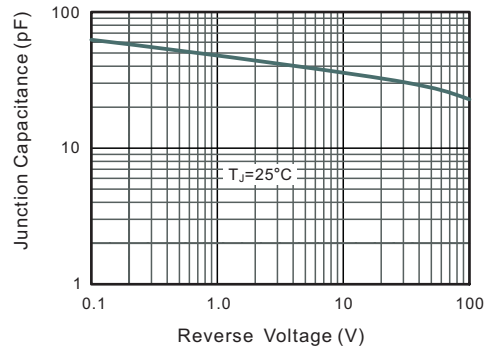
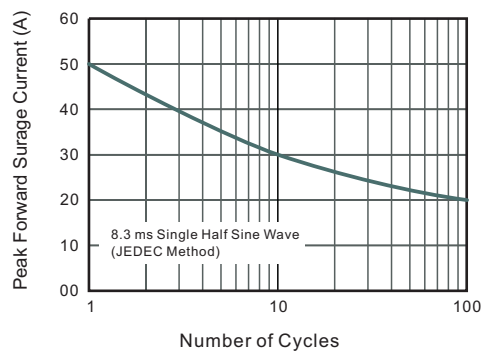

Fig.5 Maximum Non-Repetitive Peak Forward Surge Current



PACKAGE OUTLINE

Plastic surface mounted package; 2 leads

SMAF

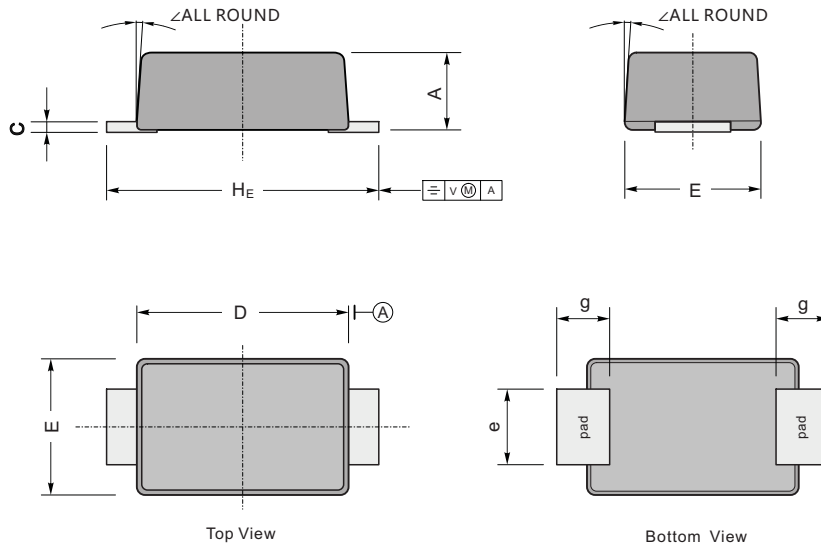

UNIT		A	C	D	E	e	g	H _E	∠
mm	max	1.1	0.20	3.7	2.7	1.6	1.2	4.9	7°
	min	0.9	0.12	3.3	2.4	1.3	0.8	4.4	
mil	max	43	7.9	146	106	63	47	193	
	min	35	4.7	130	94	51	31	173	

The recommended mounting pad size

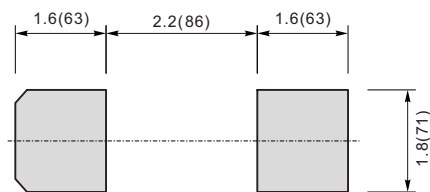

Unit: mm(mil)

单击下面可查看定价，库存，交付和生命周期等信息

[>>SHIKUES\(时科\)](#)