

Surface Mount Schottky Barrier Rectifier  
Reverse Voltage - 40V Forward Current - 5.0A

## PINNING

PIN	DESCRIPTION
1	Cathode
2	Anode

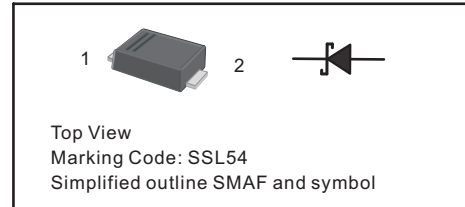

## FEATURES

- Metal silicon junction, majority carrier conduction
- For surface mounted applications
- Low power loss, high efficiency
- High forward surge current capability
- For use in low voltage, high frequency inverters, free wheeling, and polarity protection applications

## MECHANICAL DATA

- Case: SMAF
- Terminals: Solderable per MIL-STD-750, Method 2026
- Approx. Weight: 27mg / 0.00095oz

## Maximum Ratings and Electrical characteristics

Ratings at 25 °C ambient temperature unless otherwise specified.

Single phase half-wave 60 Hz, resistive or inductive load, for capacitive load current derate by 20 %.

Parameter	Symbols	SS54FL	Units
Maximum Repetitive Peak Reverse Voltage	$V_{RRM}$	40	V
Maximum RMS voltage	$V_{RMS}$	28	V
Maximum DC Blocking Voltage	$V_{DC}$	40	V
Maximum Average Forward Rectified Current at $T_c = 100\text{ }^\circ\text{C}$	$I_{F(AV)}$	5	A
Peak Forward Surge Current 8.3 ms Single Half Sine Wave Superimposed on Rated Load	$I_{FSM}$	150	A
Maximum Instantaneous Forward Voltage at 5A	$V_F$	0.45	V
Maximum DC Reverse Current at Rated DC Blocking Voltage $T_a = 25\text{ }^\circ\text{C}$ $T_a = 100\text{ }^\circ\text{C}$	$I_R$	1.0 50	mA
Typical Junction Capacitance <sup>(1)</sup>	$C_j$	800	pF
Typical Thermal Resistance <sup>(2)</sup>	$R_{\theta JA}$	45	$^\circ\text{C/W}$
Operating Junction Temperature Range	$T_j$	-55 ~ +150	$^\circ\text{C}$
Storage Temperature Range	$T_{stg}$	-55 ~ +150	$^\circ\text{C}$

(1) Measured at 1 MHz and applied reverse voltage of 4 V D.C

(2) P.C.B. mounted with 2.0" X 2.0" (5 X 5 cm) copper pad areas.

**Fig.1 Forward Current Derating Curve**

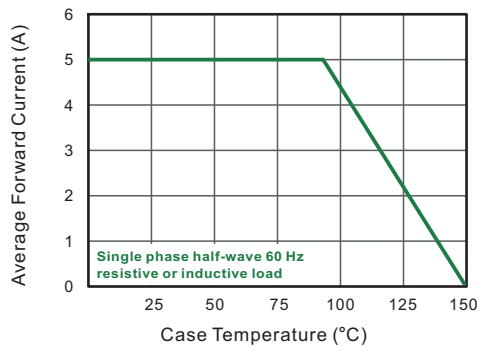

**Fig.2 Typical Reverse Characteristics**

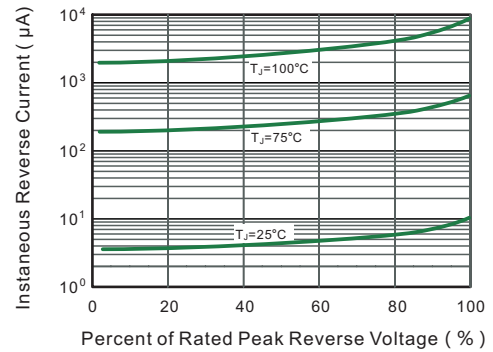

**Fig.3 Typical Forward Characteristic**

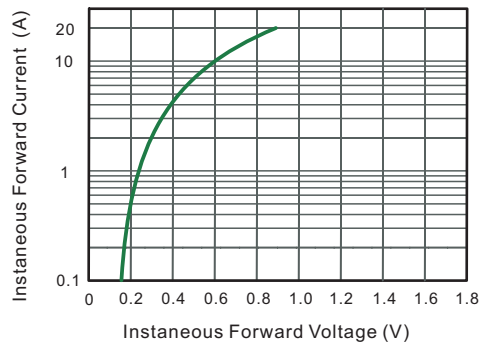

**Fig.4 Typical Junction Capacitance**

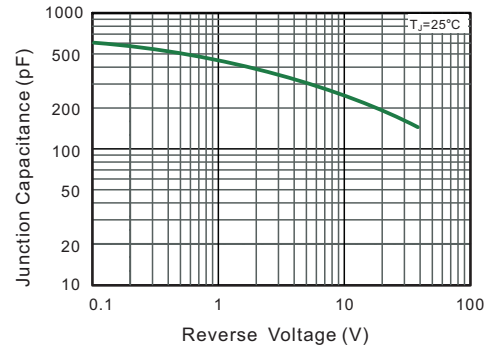

**Fig.5 Maximum Non-Repetitive Peak Forward Surge Current**

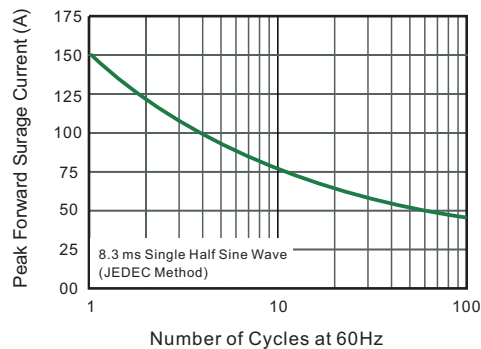

**Fig.6- Typical Transient Thermal Impedance**

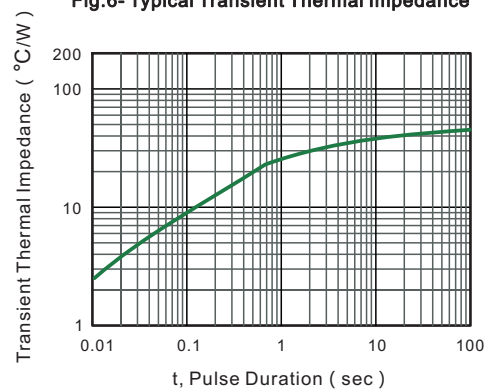

## PACKAGE OUTLINE

Plastic surface mounted package; 2 leads

SMAF

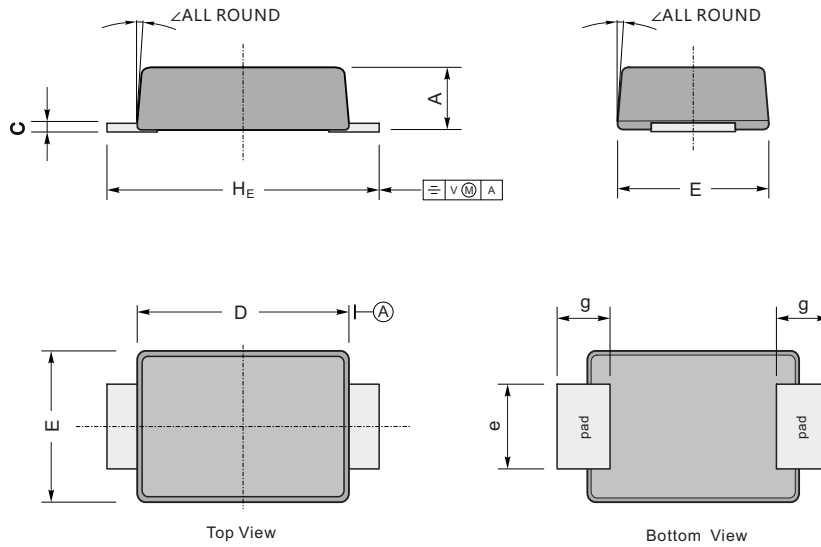

UNIT		A	C	D	E	e	g	H <sub>E</sub>	∠
mm	max	1.2	0.20	3.7	2.7	1.6	1.2	4.9	7°
	min	0.9	0.12	3.3	2.4	1.3	0.8	4.4	
mil	max	47	7.9	146	106	63	47	193	
	min	35	4.7	130	94	51	31	173	

### The recommended mounting pad size

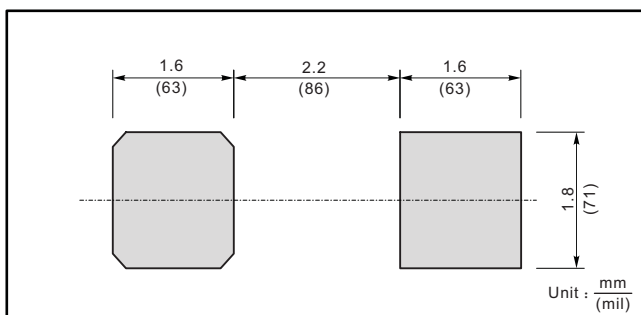

### Marking

Type number	Marking code
SS54FL	SSL54

单击下面可查看定价，库存，交付和生命周期等信息

[>>SHIKUES\(时科\)](#)