

N-Channel Enhancement Mode MOSFET

Feature

- 18V/3.5A, $R_{DS(ON)} = 80\text{m}\Omega$ (MAX) @ $V_{GS} = 4.5\text{V}$.
 $R_{DS(ON)} = 90\text{m}\Omega$ (MAX) @ $V_{GS} = 2.5\text{V}$.
- Super High dense cell design for extremely low $R_{DS(ON)}$.
- Reliable and Rugged.
- SOT-23 for Surface Mount Package.

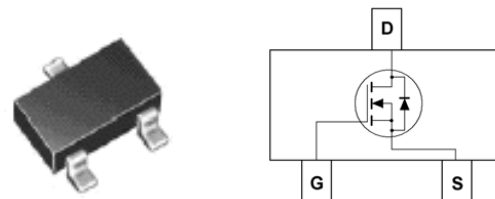

Applications

- Power Management
Portable Equipment and Battery Powered Systems.

SOT-23

Absolute Maximum Ratings

$T_A = 25^\circ\text{C}$ Unless Otherwise noted

Parameter	Symbol	Limit	Units
Drain-Source Voltage	V_{DS}	18	V
Gate-Source Voltage	V_{GS}	± 8	V
Drain Current-Continuous	I_D	3.5	A

Electrical Characteristics

$T_A = 25^\circ\text{C}$ Unless Otherwise noted

Parameter	Symbol	Test Conditions	Min	Typ.	Max	Units
Off Characteristics						
Drain to Source Breakdown Voltage	BVDSS	$V_{GS} = 0\text{V}, I_D = 250\mu\text{A}$	18	-	-	V
Zero-Gate Voltage Drain Current	IDSS	$V_{DS} = 12\text{V}, V_{GS} = 0\text{V}$	-	-	1	μA
Gate Body Leakage Current, Forward	IGSSF	$V_{GS} = 8\text{V}, V_{DS} = 0\text{V}$	-	-	100	nA
Gate Body Leakage Current, Reverse	IGSSR	$V_{GS} = -8\text{V}, V_{DS} = 0\text{V}$	-	-	-100	nA
On Characteristics						
Gate Threshold Voltage	$V_{GS(th)}$	$V_{GS} = V_{DS}, I_D = 250\mu\text{A}$	0.4	-	1.3	V
Static Drain-source On-Resistance	RDS(ON)	$V_{GS} = 4.5\text{V}, I_D = 3.5\text{A}$	-	70	80	$\text{m}\Omega$
		$V_{GS} = 2.5\text{V}, I_D = 3.1\text{A}$	-	75	90	$\text{m}\Omega$
Drain-Source Diode Characteristics and Maximum Ratings						
Drain-Source Diode Forward Voltage	VSD	$V_{GS} = 0\text{V}, I_S = 0.94\text{A}$			1.2	V

Typical Characteristics

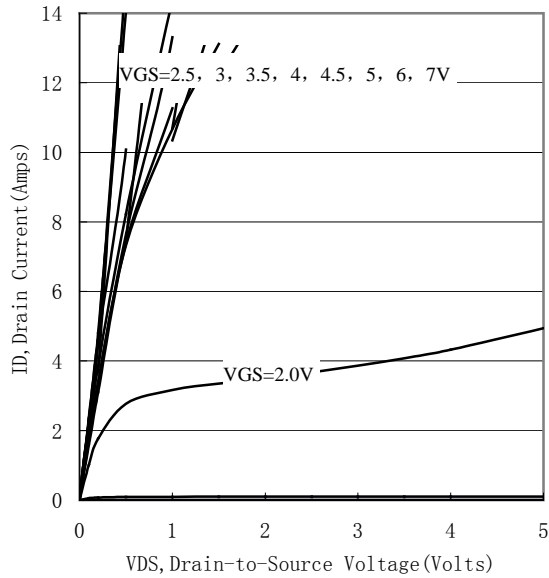

Figure 1. Output Characteristics

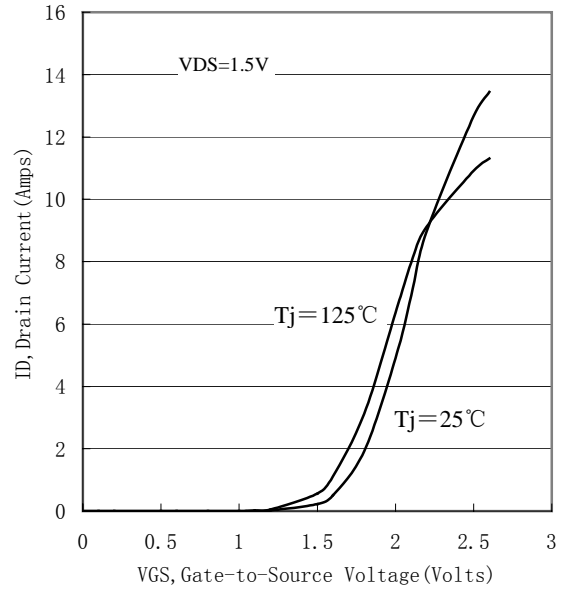

Figure 2. Transfer Characteristics

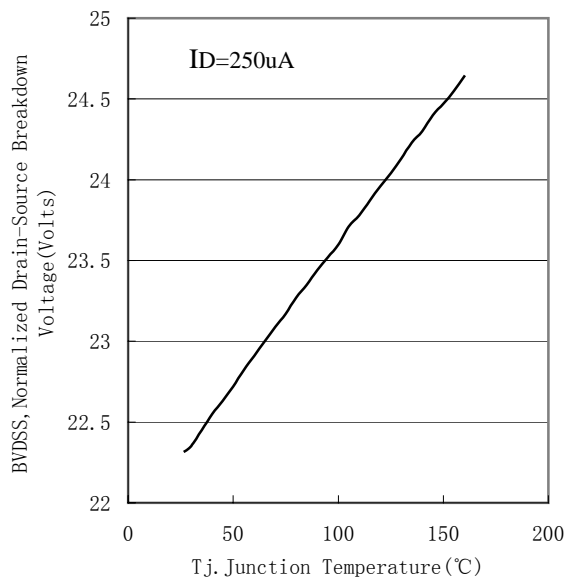

Figure 3. Breakdown Voltage Variation with Temperature

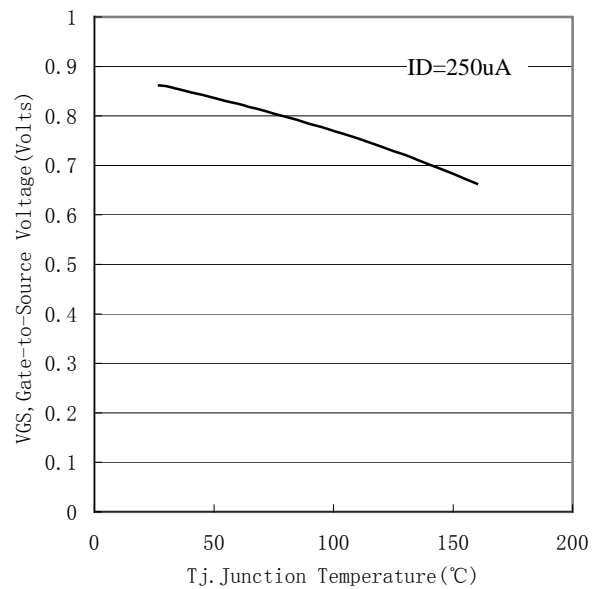

Figure 4. Gate Threshold Variation with Temperature

Typical Characteristics

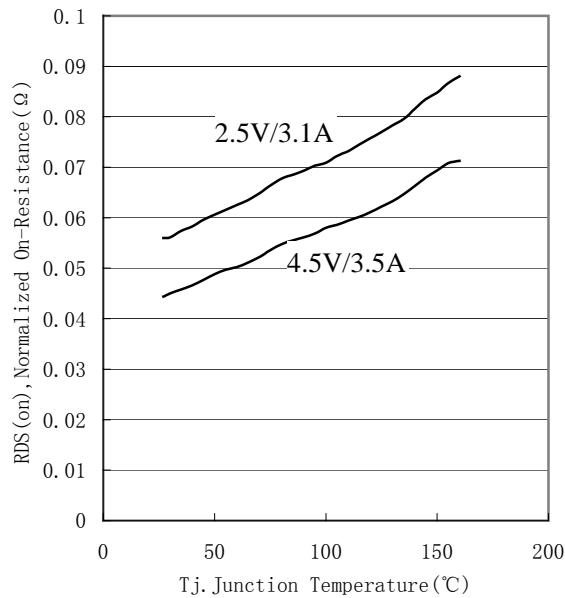

Figure 5. On-Resistance Variation with Temperature

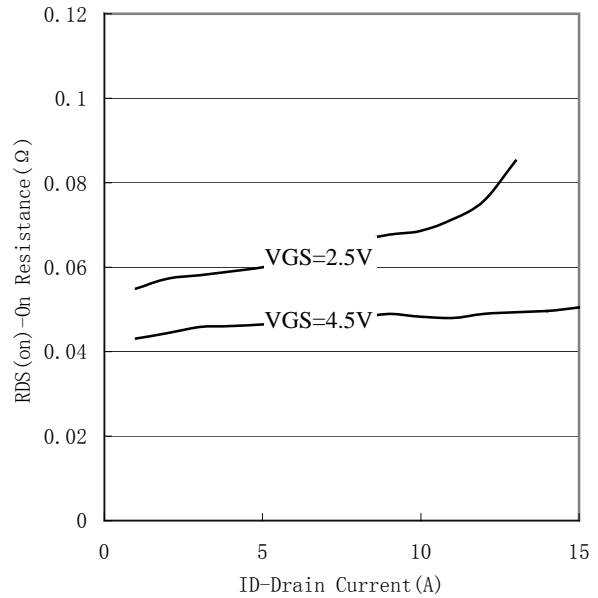

Figure 6. On-Resistance vs. Drain Current

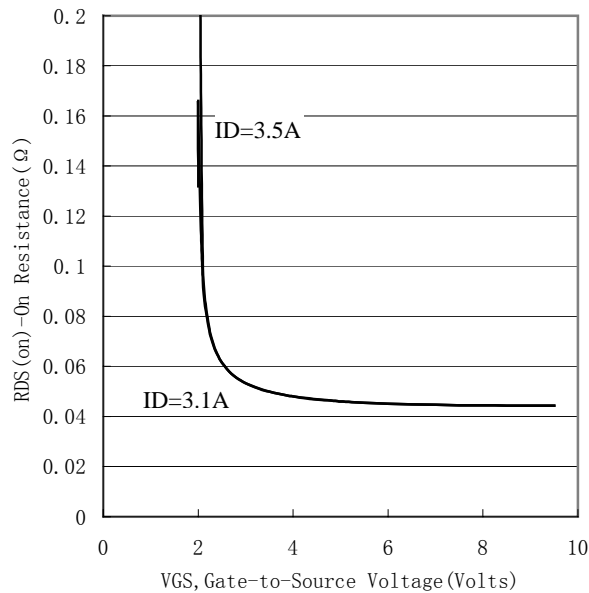

Figure 7. On-Resistance vs. Gate-to-Source Voltage

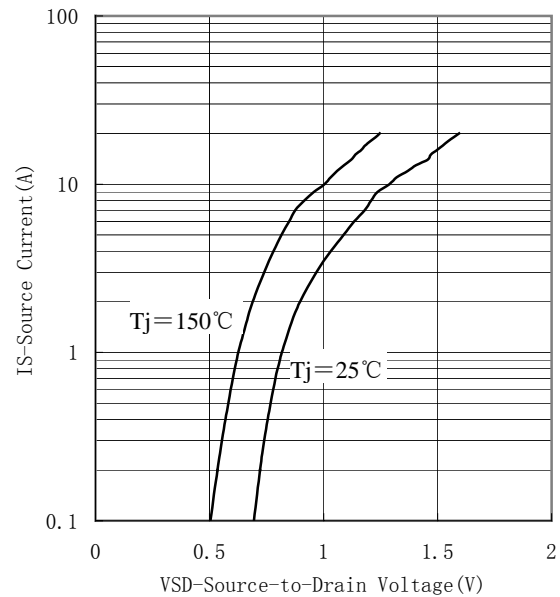
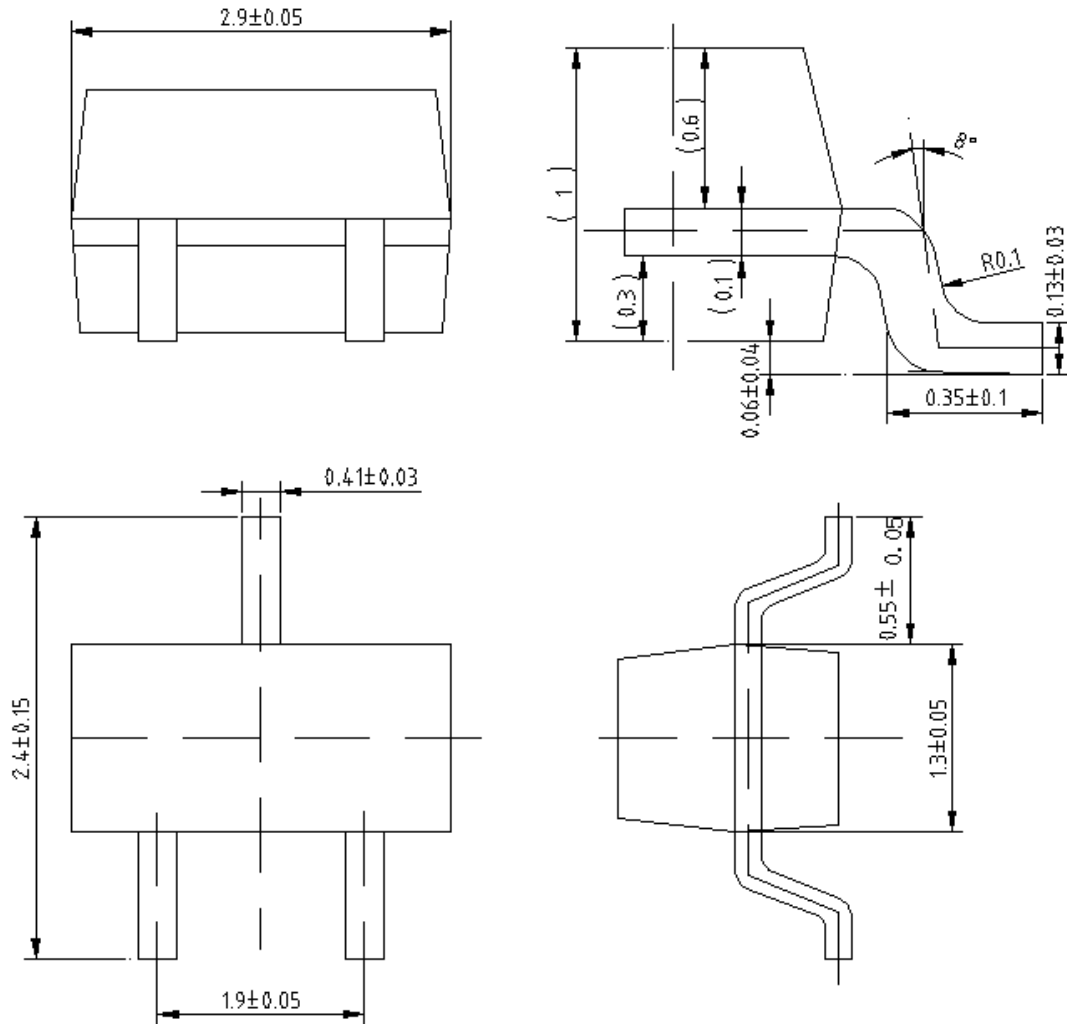

Figure 8. Source-Drain Diode Forward Voltage



单击下面可查看定价，库存，交付和生命周期等信息

[>>SHIKUES\(时科\)](#)