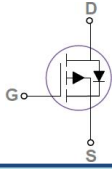
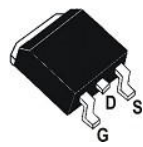

60V P-Channel MOSFET

BV _{DSS} -60V R _{DS(ON)} 48mΩ(max.)@ V _{GS} =10V R _{DS(ON)} 65mΩ(max.)@ V _{GS} =4.5V I _D -16A	
Description	TO-252
The SK15P06 uses advanced Trench technology and designs to provide excellent R _{DS(ON)} with low gate charge. This device is suitable for use in PWM, load switching and general purpose applications.	
Applications	Features
<ul style="list-style-type: none"> ■ Motor Drive ■ Power Tool ■ LED Application 	<ul style="list-style-type: none"> ■ Low On-Resistance ■ Low Input Capacitance ■ Fast Switching

Absolute Maximum Ratings (T_A=25°C unless otherwise noted)

Parameter	Symbol	Value	Unit
Drain-Source Voltage	V _{DSS}	-60V	V
Gate-Source Voltage	V _{GSS}	±20V	V
Drain Current-Continuous @ T _C =25°C	I _D	-16	A
Drain Current-Continuous @ T _C =100°C		-10	A
Drain Current-Pulsed ^{NOTE 1}	I _{DM}	-64	A
Single Pulse Avalanche Energy ^{NOTE 2}	EAS	51	mJ
Single Pulse Avalanche Current ^{NOTE 2}	IAS	-32	A
Maximum Power Dissipation @ T _C =25°C	P _D	25	W
Maximum Power Dissipation – Derate above 25°C		0.2	W / °C
Storage Temperature Range	T _{STG}	-55 to 150°C	°C
Operating Junction Temperature Range	T _J	-55 to 150°C	°C

Thermal Resistance Ratings

Parameter	Symbol	Conditions	Min.	Typ.	Max.	Unit
Maximum Junction-to-Ambient	R _{θJA}	Steady State	-	-	62	°C/W
Maximum Junction-to-Case	R _{θJC}	Steady State	-	-	5	°C/W

60V P-Channel MOSFET

Electrical Characteristics($T_J=25^{\circ}\text{C}$ unless otherwise noted)						
Parameter	Symbol	Conditions	Min.	Typ.	Max.	Unit
OFF CHARACTERISTICS						
Drain-Source Breakdown Voltage	BV_{DSS}	$V_{GS}=0V, I_{DS}=-250\mu A$	-60	-	-	V
Zero Gate Voltage Drain Current	I_{DSS}	$V_{DS}=-48V, V_{GS}=0V$	-	-	-1	μA
Gate-Source Leakage Current	I_{GSS}	$V_{GS}=\pm 20V, V_{DS}=0V$	-	-	± 100	nA
ON CHARACTERISTICS						
Gate Threshold Voltage	$V_{GS(TH)}$	$V_{GS}=V_{DS}, I_{DS}=-250\mu A$	-1.0	-1.6	-2.5	V
Drain-Source On-Resistance	$R_{DS(ON)}$	$V_{GS}=-10V, I_{DS}=-8A$	-	40	48	$m\Omega$
		$V_{GS}=-4.5V, I_{DS}=-4A$	-	53	65	$m\Omega$
Forward Transconductance	g_{fs}	$V_{DS}=-10V, I_D=-8A$	-	10	-	S
DYNAMIC CHARACTERISTICS						
Input Capacitance	C_{iss}	$V_{DS}=-30V, V_{GS}=0V, f=1\text{MHz}$	-	1250	-	μF
Output Capacitance	C_{oss}		-	90	-	
Reverse Transfer Capacitance	C_{rss}		-	58	-	
SWITCHING CHARACTERISTICS						
Turn-On Delay Time ^{NOTE 3, 4}	$T_{d(on)}$	$V_{DS}=-30V, V_{GS}=-10V, I_D=-1A, R_{GEM}=6\Omega$	-	13.5	-	ns
Rise Time ^{NOTE 3, 4}	t_r		-	42	-	
Turn-Off Delay Time ^{NOTE 3, 4}	$T_{d(off)}$		-	66	-	
Fall Time ^{NOTE 3, 4}	t_f		-	15.8	-	
Total Gate Charge at 4.5V ^{NOTE 3, 4}	Q_g	$V_{DS}=-30V, I_{DS}=-8A, V_{GS}=-10V$	-	23	-	nC
Gate to Source Gate Charge ^{NOTE 3, 4}	Q_{gs}		-	4	-	
Gate to Drain "Miller" Charge ^{NOTE 3, 4}	Q_{gd}		-	5.1	-	
DIODE CHARACTERISTICS						
Drain-Source Diode Forward Voltage	V_{SD}	$V_{GS}=0V, I_S=1A, T_J=25^{\circ}\text{C}$	-	-	-1.0	V
Continuous Source Current	I_S	$V_G=V_D=0V, \text{Force Current}$	-	-	-16	A
Pulsed Source Current	I_{SM}		-	-	-64	A

Notes:

1. Repetitive Rating : Pulsed width limited by maximum junction temperature.
2. The data tested by pulsed , pulse width $\leq 300\mu s$, duty cycle $\leq 2\%$.
3. Essentially independent of operating temperature

60V P-Channel MOSFET

Typical Operating Characteristics

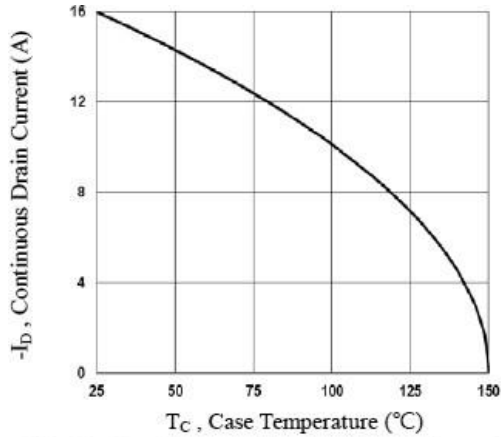

Fig.1 Continuous Drain Current vs. T_c

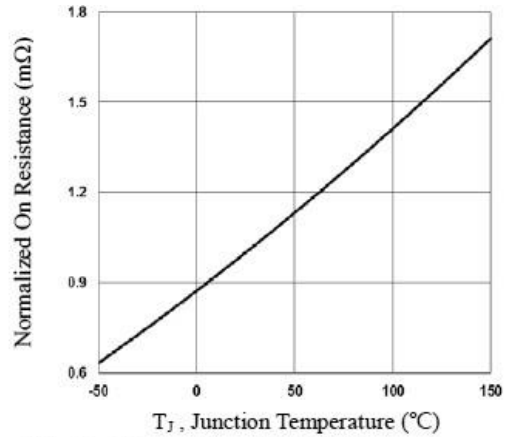

Fig.2 Normalized $R_{DS(on)}$ vs. T_j

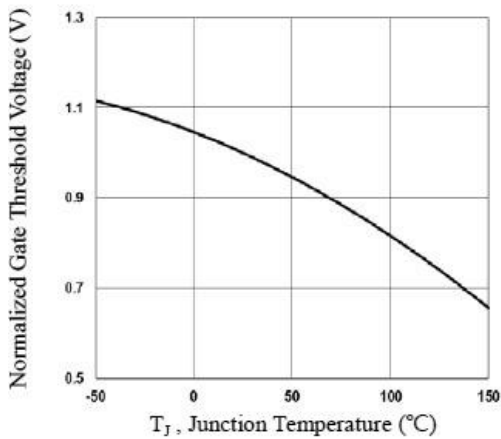

Fig.3 Normalized V_{th} vs. T_j

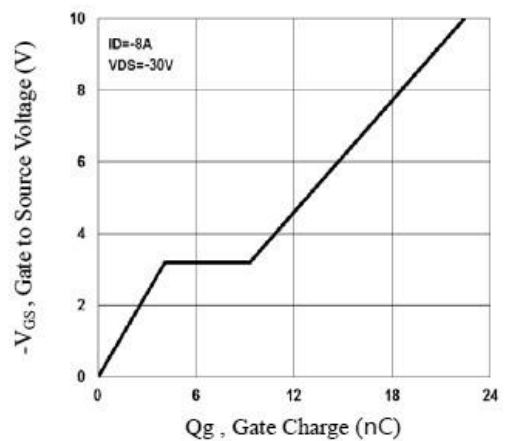

Fig.4 Gate Charge Waveform

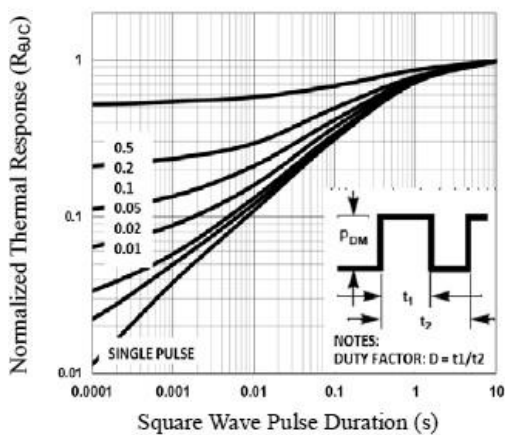

Fig.5 Normalized Transient Impedance

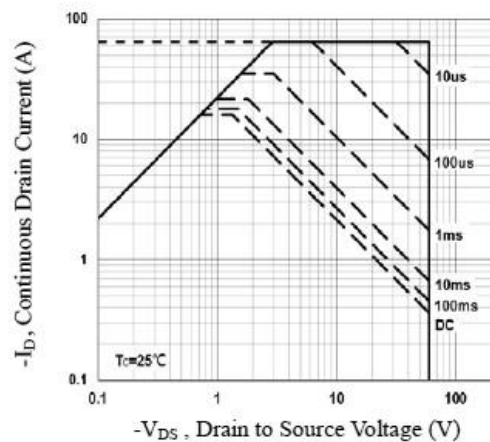

Fig.6 Maximum Safe Operation Area

60V P-Channel MOSFET Typical Operating Characteristics (Cont.)

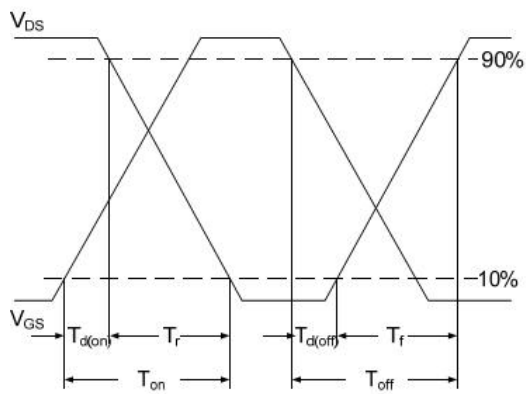

Fig.7 Switching Time Waveform

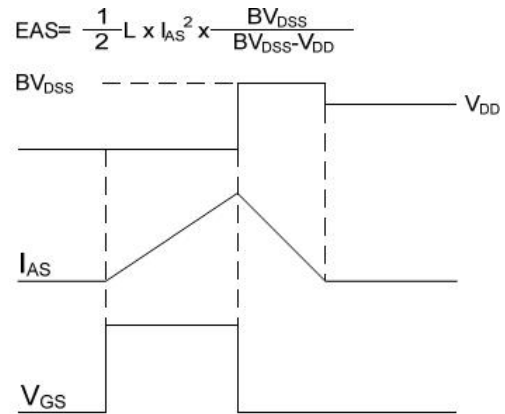
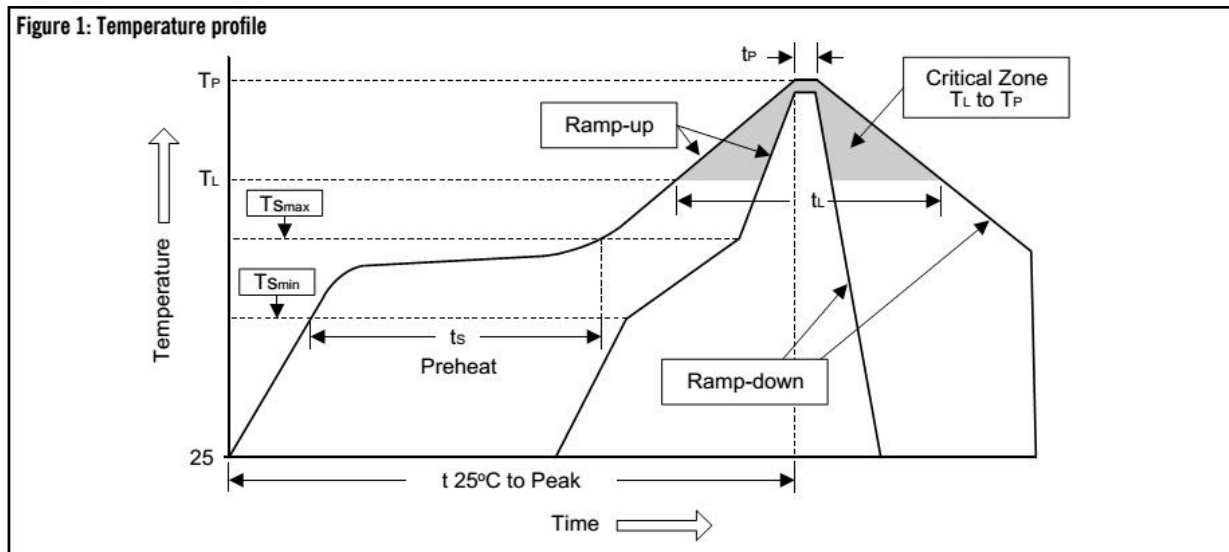

Fig.8 EAS Waveform

60V P-Channel MOSFET

Soldering Methods for RA Product

1. Storage environment: Temperature=10°C to 35°C Humidity=65% ± 15%
2. Reflow soldering of surface-mount devices



Profile Feature	Sn-Pb Eutectic Assembly	Pb-Free Assembly
Average ramp-up rate (T_L to T_P)	<3°C/sec	<3°C/sec
Preheat		
- Temperature Min (T_{Smin})	100°C	150°C
- Temperature Max (T_{Smax})	150°C	200°C
- Time (min to max) (t_s)	60 to 120 sec	60 to 180 sec
T_{Smax} to T_L		
- Ramp-up Rate	<3°C/sec	<3°C/sec
Time maintained above:		
- Temperature (T_L)	183°C	217°C
- Time (t_L)	60 to 150 sec	60 to 150 sec
Peak Temperature (T_P)	240°C +0/-5°C	260°C +0/-5°C
Time within 5°C of actual Peak Temperature (t_p)	10 to 30 sec	20 to 40 sec
Ramp-down Rate	<6°C/sec	<6°C/sec
Time 25°C to Peak Temperature	<6 minutes	<8 minutes

3. Flow (wave) soldering (solder dipping)

Products	Peak Temperature	Dipping Time
Pb devices.	245°C ±5°C	5sec ±1sec
Pb-Free devices.	260°C +0/-5°C	5sec ±1sec

60V P-Channel MOSFET

PACKAGE DIMENSION

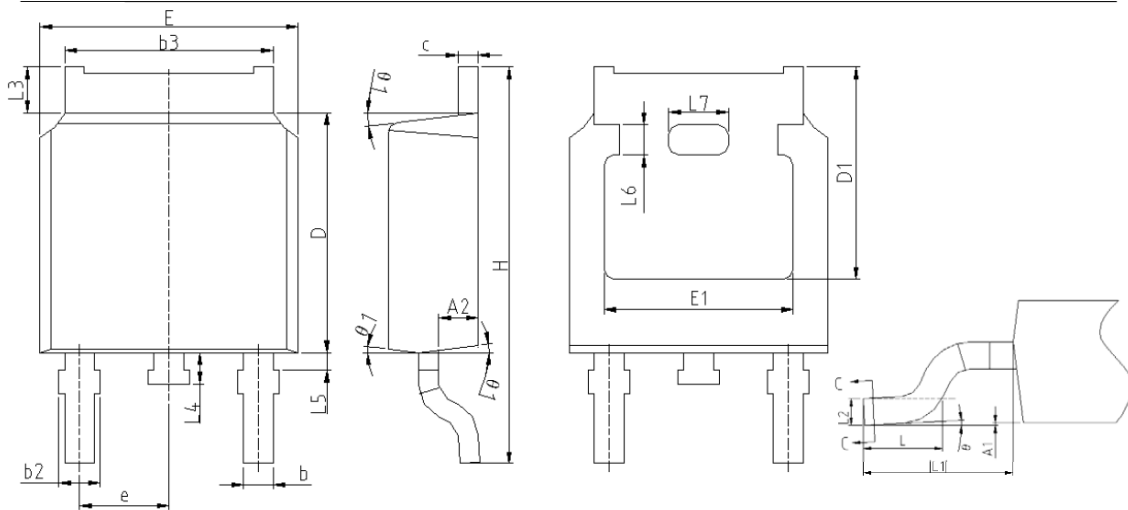

Symbol	TO-252			
	Millimeters		Inches	
	Min.	Max.	Min.	Max.
A	2.184	2.338	0.086	0.094
A1	0.890	1.143	0.035	0.045
b	0.635	0.890	0.025	0.035
b2	0.910	1.143	0.035	0.045
b3	4.953	5.460	0.195	0.215
c	0.457	0.610	0.018	0.024
c1	0.457	0.890	0.018	0.035
D	5.334	6.223	0.210	0.245
D1	5.207		0.205	
E	6.350	6.730	0.250	0.265
E1	4.320		0.170	
e	2.29 BSC		0.090 BSC	
L	3.700	4.400	0.146	0.173
L1	0.850	1.250	0.033	0.049
L2	0.890	1.270	0.035	0.050

单击下面可查看定价，库存，交付和生命周期等信息

[>>SHIKUES\(时科\)](#)