

1N4448W Silicon Epitaxial Planar Switching Diode

Fast Switching Diode

PINNING

PIN	DESCRIPTION
1	Cathode
2	Anode

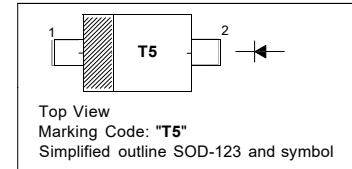

Absolute Maximum Ratings ($T_a = 25\text{ }^\circ\text{C}$)

Parameter	Symbol	Value	Unit
Peak Reverse Voltage	V_{RM}	100	V
Reverse Voltage	V_R	80	V
Average Rectified Forward Current	$I_{F(AV)}$	150	mA
Forward Continuous Current	I_{FM}	300	mA
Non-Repetitive Peak Forward Surge Current (at $t = 1\text{ }\mu\text{s}$)	I_{FSM}	4	A
Power Dissipation	P_d	400	mW
Junction Temperature	T_j	150	$^\circ\text{C}$
Storage Temperature Range	T_{stg}	- 65 to + 150	$^\circ\text{C}$

Characteristics at $T_a = 25\text{ }^\circ\text{C}$

Parameter	Symbol	Min.	Max.	Unit
Forward Voltage at $I_F = 5\text{ mA}$ at $I_F = 10\text{ mA}$ at $I_F = 100\text{ mA}$ at $I_F = 150\text{ mA}$	V_F	0.62 - - -	0.72 0.855 1 1.25	V
Reverse Leakage Current at $V_R = 80\text{ V}$ at $V_R = 20\text{ V}$ at $V_R = 75\text{ V}, T_J = 150\text{ }^\circ\text{C}$ at $V_R = 25\text{ V}, T_J = 150\text{ }^\circ\text{C}$	I_R	- - - -	100 25 50 30	nA nA μA μA
Reverse Breakdown Voltage at $I_R = 100\text{ }\mu\text{A}$	$V_{(BR)R}$	80	-	V
Total Capacitance at $V_R = 0.5\text{ V}, f = 1\text{ MHz}$	C_{tot}	-	4	pF
Reverse Recovery Time at $I_F = I_R = 10\text{ mA}, I_{rr} = 0.1 \times I_R, R_L = 100\text{ }\Omega$	t_{rr}	-	4	ns

Typical Characteristics

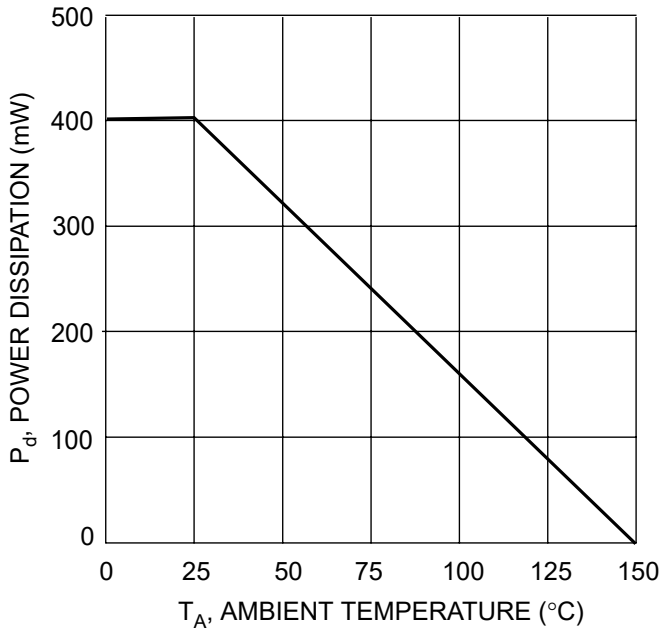

Fig. 1 Power Derating Curve

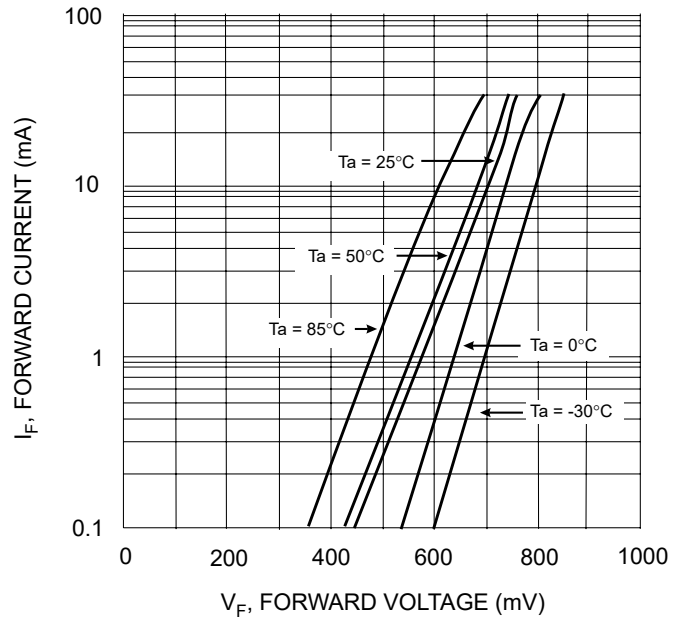

Fig. 2 Typical Forward Characteristics

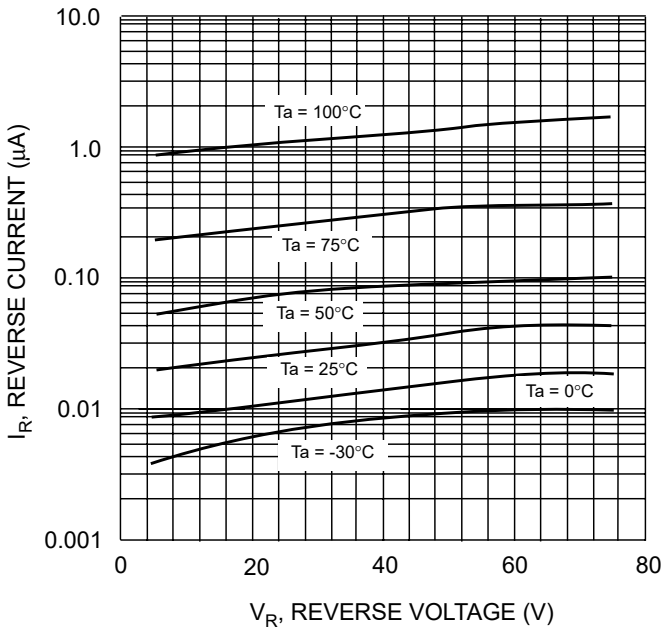

Fig. 3 Typical Reverse Characteristics

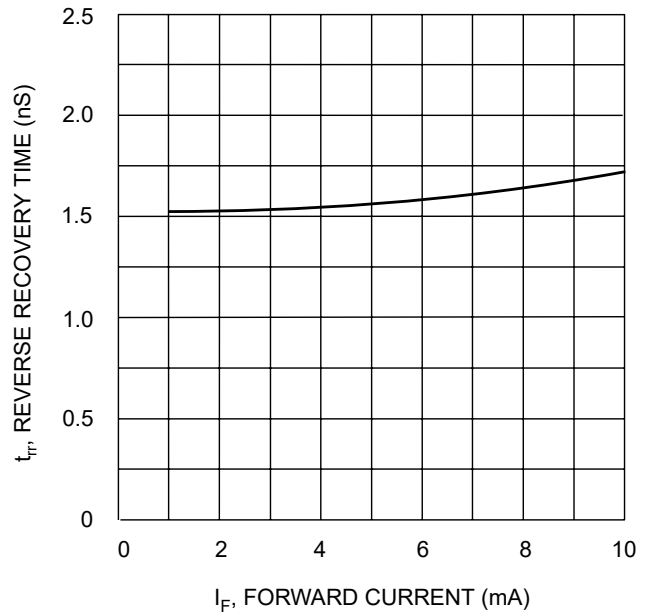

Fig. 4 Reverse Recovery Time vs. Forward Current

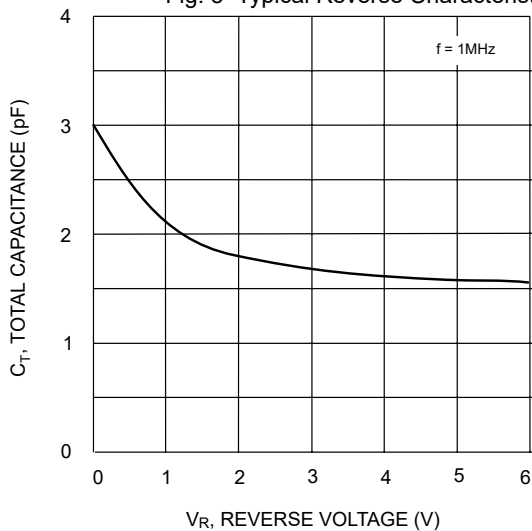
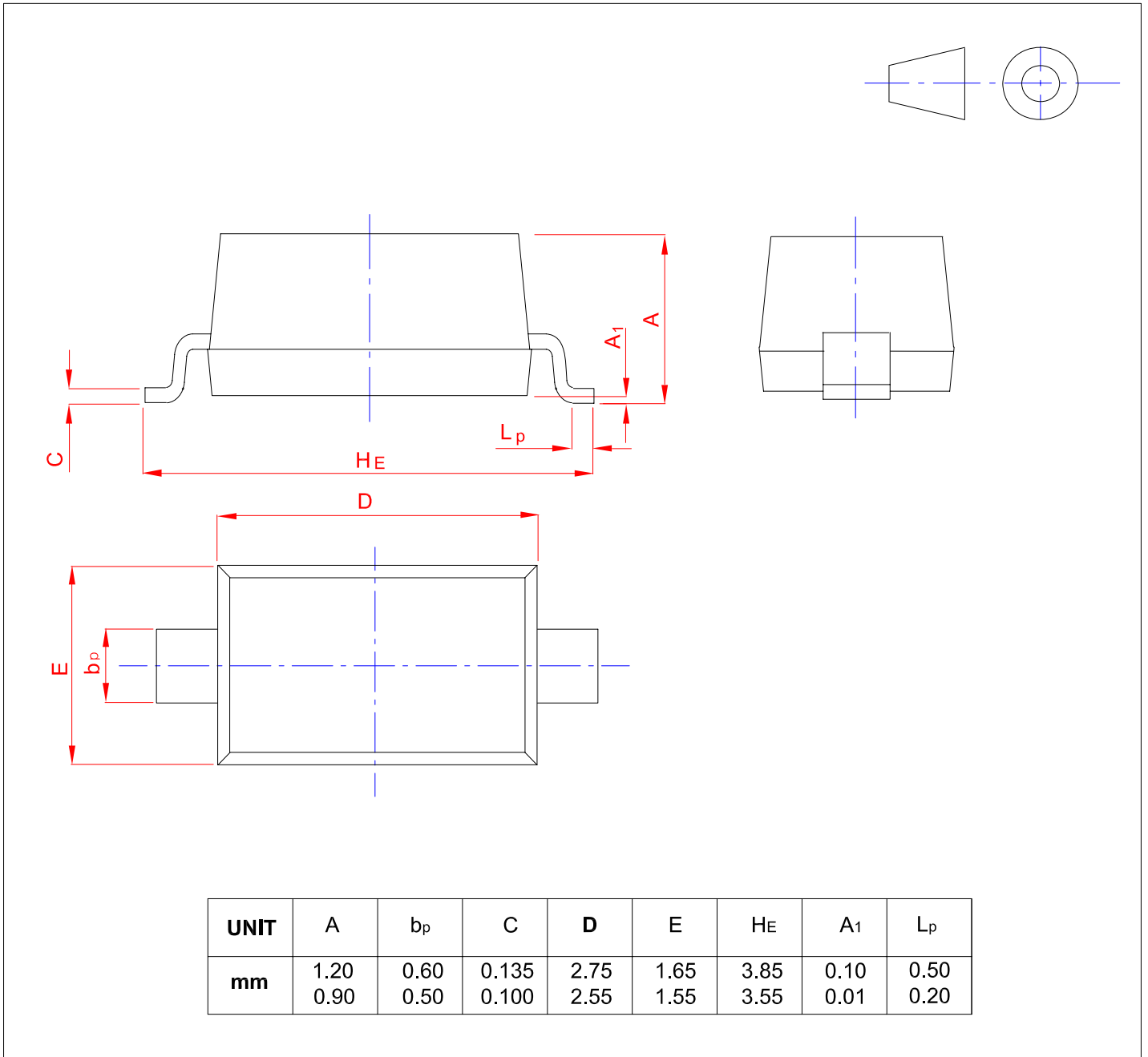

Fig. 5 Total Capacitance vs. Reverse Voltage

PACKAGE OUTLINE

Plastic surface mounted package; 2 leads

SOD-123



单击下面可查看定价，库存，交付和生命周期等信息

[>>SHIKUES\(时科\)](#)