



SILERGY

SY8104I

High Efficiency, Fast Response, 4.0A, 18V Input Synchronous Step Down Regulator

General Description

The SY8104I is a high efficiency 500kHz synchronous step-down DC/DC regulator, which is capable of delivering up to 4A load current. It can operate over a wide input voltage range from 4.2V to 18V and integrate main switch and synchronous switch with very low $R_{DS(ON)}$ to minimize the conduction loss.

The SY8104I adopts the instant PWM architecture to achieve fast transient responses for high step down applications and high efficiency at light loads. In addition, it operates at pseudo-constant frequency of 500kHz to minimize the size of inductor and capacitor.

Ordering Information

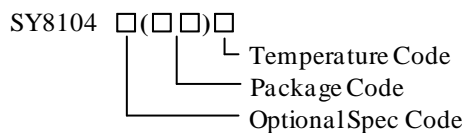

Ordering Number	Package type	Note
SY8104IADC	TSOT23-6	----

Features

- Low $R_{DS(ON)}$ for Internal Switches (Top/Bottom): 55mΩ/36mΩ
- 4.2-18V Input Voltage Range
- 4A Output Current Capability
- 500kHz Switching Frequency Minimize the External Components
- Stable with 22μF C_{OUT} and 0.68μH Inductor
- Instant PWM Architecture to Achieve Fast Transient Responses
- Internal Soft-Start Limits the Inrush Current
- Cycle-by-cycle Peak/Valley Current Limitation
- Hic-cup Mode Output Short Circuit Protection
- Thermal Shutdown with Auto Recovery
- Output Auto Discharge Function
- Compact Package: TSOT23-6

Applications

- Set Top Box
- Portable TV
- DSL Modem
- LCD TV
- IP CAM
- Networking

Typical Application

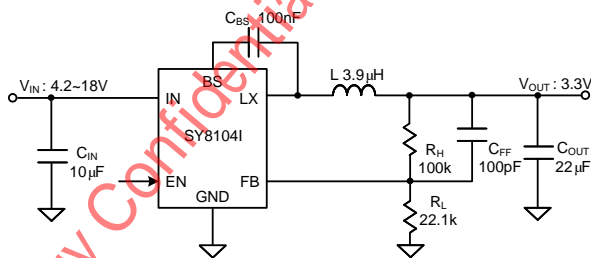

Figure1. Schematic Diagram

Inductor and C_{OUT} Selection Table

V_{OUT} [V]	L [μH]	C_{OUT} [μF]			
		4.7	10	22	2×22
1.2	0.68		✓	✓	✓
	2.0		✓	☆	✓
3.3	1.5		✓	✓	✓
	3.9		✓	☆	✓
5	2.2		✓	✓	✓
	4.7		✓	☆	✓

Note: '☆' means recommended for most applications.

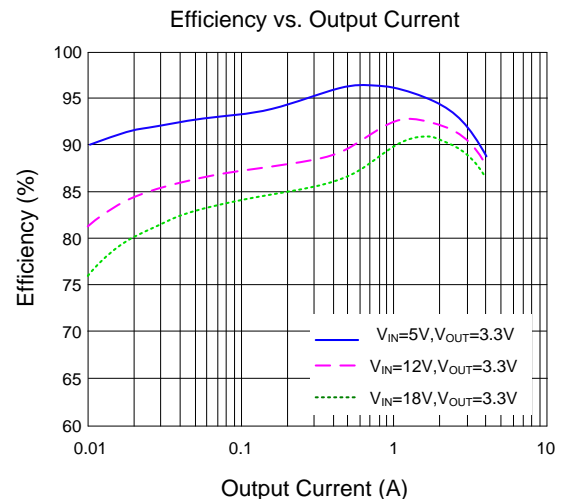
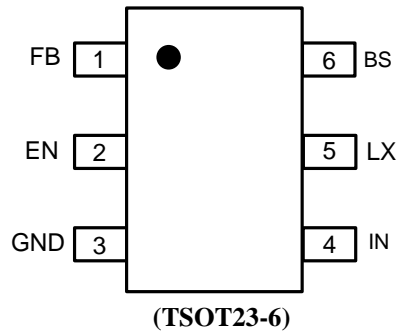

Figure2. Efficiency vs. Output Current

Pinout (top view)



Top mark: **dLxyz** (Device code: dL, x=year code, y=week code, z=lot number code)

Pin Name	Pin Number	Pin Description
FB	1	Feedback pin. Connect this pin to the center point of the output resistor divider (as shown in Figure 1) to program the output voltage: $V_{OUT}=0.6 \times (1+R_H/R_L)$.
EN	2	Enable control pin. Pull high to turn on. Do not leave it floating.
GND	3	Power ground pin.
IN	4	Input pin. Decouple this pin to the GND pin with at least a 10 μ F ceramic capacitor.
LX	5	Inductor pin. Connect this pin to the switching node of inductor.
BS	6	Boot-strap pin. Supply high side gate driver. Connect a 0.1 μ F ceramic capacitor between BS and LX pin.

Block Diagram

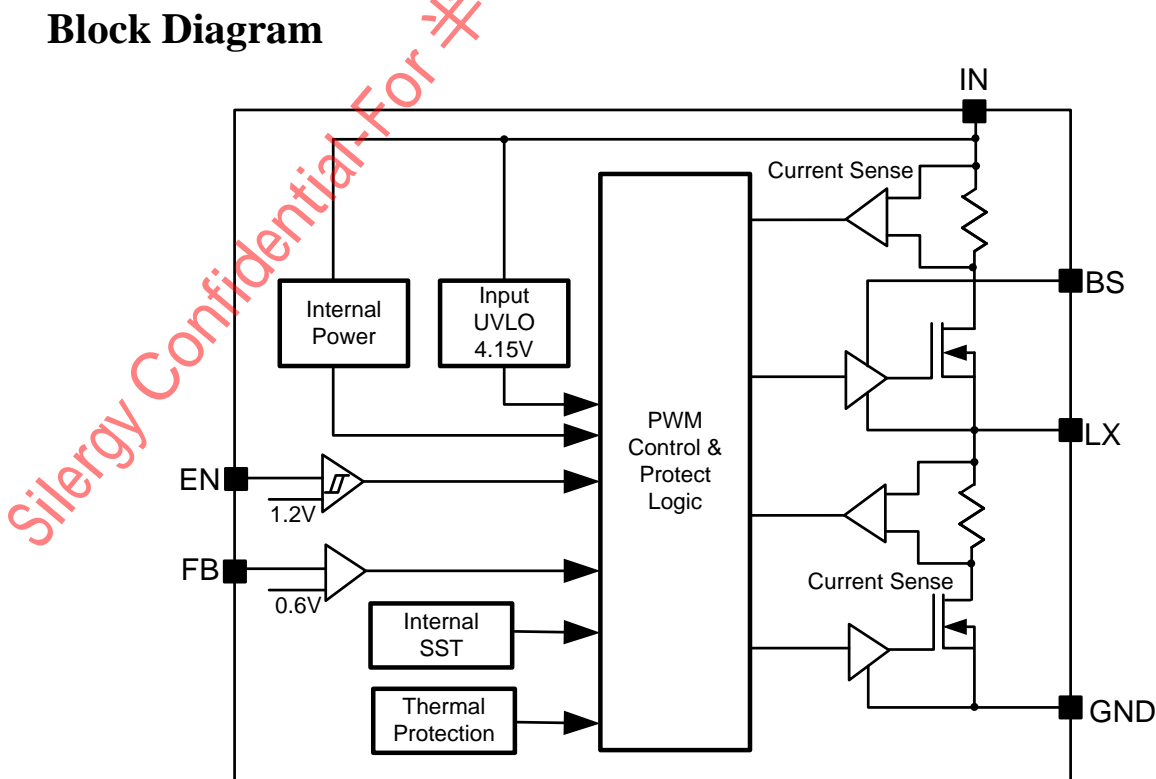

Figure3. Block Diagram

Absolute Maximum Ratings (Note 1)

Supply Input Voltage	-----	-0.3V to 19V
LX, EN Voltage	-----	-0.3V to $V_{IN} + 0.3V$
FB, BS-LX Voltage	-----	-0.3V to 4V
Power Dissipation, P_D @ $T_A = 25\text{ }^\circ\text{C}$ TSOT23-6,	-----	2.0W
Package Thermal Resistance (Note 2)		
θ_{JA}	-----	50 $^\circ\text{C/W}$
θ_{JC}	-----	6.3 $^\circ\text{C/W}$
Junction Temperature Range	-----	-40 $^\circ\text{C}$ to 150 $^\circ\text{C}$
Lead Temperature (Soldering, 10 sec.)	-----	260 $^\circ\text{C}$
Storage Temperature Range	-----	-65 $^\circ\text{C}$ to 150 $^\circ\text{C}$
Dynamic LX Voltage in 10ns Duration (Note3)	-----	IN+3V to GND-5V

Recommended Operating Conditions (Note 3)

Supply Input Voltage	-----	4.2V to 18V
Junction Temperature Range	-----	-40 $^\circ\text{C}$ to 125 $^\circ\text{C}$
Ambient Temperature Range	-----	-40 $^\circ\text{C}$ to 85 $^\circ\text{C}$

Silergy Confidential-For 半导体芯

Electrical Characteristics

($V_{IN} = 12V$, $V_{OUT} = 3.3V$, $L = 3.9\mu H$, $C_{OUT} = 22\mu F$, $T_A = 25^\circ C$, $I_{OUT} = 1A$ unless otherwise specified)

Parameter	Symbol	Test Conditions	Min	Typ	Max	Unit
Input Voltage Range	V_{IN}		4.2		18	V
Input UVLO Threshold	V_{UVLO}				4.15	V
Input UVLO Hysteresis	V_{HYS}			0.3		V
Quiescent Current	I_Q	$I_{OUT}=0$, $V_{FB}=V_{REF}\times 105\%$		200	280	μA
Shutdown Current	I_{SHDN}	EN=0		5	10	μA
Feedback Reference Voltage	V_{REF}		591	600	609	mV
FB Input Current	I_{FB}	$V_{FB}=3.3V$	-50		50	nA
Output Discharge Resistance	R_{DIS}			50		Ω
Top FET R_{ON}	$R_{DS(ON)1}$			55	105	m Ω
Bottom FET R_{ON}	$R_{DS(ON)2}$			36	55	m Ω
EN Rising Threshold	$V_{EN,R}$		1.08	1.2	1.32	V
EN Falling Threshold	$V_{EN,F}$		0.9	1.0	1.1	V
Min ON Time	$t_{ON,MIN}$			50		ns
Min OFF Time	$t_{OFF,MIN}$			100		ns
Turn On Delay	$t_{ON,DLY}$	from EN high to LX start switching		0.5		ms
Soft-start Time	t_{SS}	V_{OUT} from 0 to 100%	1	1.7	2.4	ms
Switching Frequency	F_{SW}	$V_{OUT}=3.3V$, CCM		500		kHz
Top FET Current Limit	$I_{LIM, TOP}$			5.5		A
Bottom FET Current Limit	$I_{LIM, BOT}$		4			A
Output Under Voltage Protection Threshold	V_{UVP}			0.33		V_{REF}
Output UVP Delay	$t_{UVP,DLY}$			100		μs
UVP Hiccup ON Time	$t_{UVP, ON}$			2.5		ms
UVP Hiccup OFF Time	$t_{UVP, OFF}$			9		ms
Thermal Shutdown Temperature	T_{SD}			150		$^\circ C$
Thermal Shutdown Hysteresis	T_{HYS}			15		$^\circ C$

Note 1: Stresses beyond the “Absolute Maximum Ratings” may cause permanent damage to the device. These are stress ratings only. Functional operation of the device at these or any other conditions beyond those indicated in the operational sections of the specification is not implied. Exposure to absolute maximum rating conditions for extended periods may affect device reliability.

Note 2: θ_{JA} is measured in the natural convection at $T_A = 25^\circ C$ on a 20Z four-layer Silergy evaluation board. Paddle of TSOT23-6 package is the case position for SY8104I θ_{JC} measurement.

Note 3: The device is not guaranteed to function outside its operating conditions.

TSOT23-6 Package Outline & PCB Layout

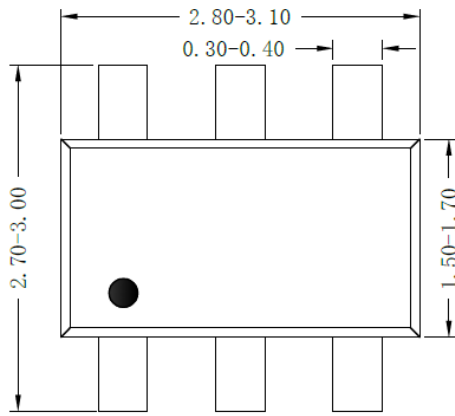

Top view

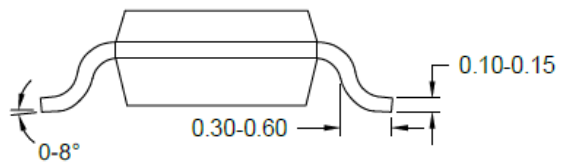

Side view

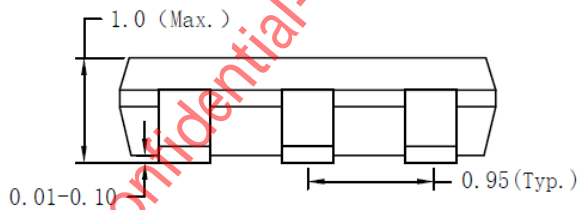

Front view

Recommended Pad Layout

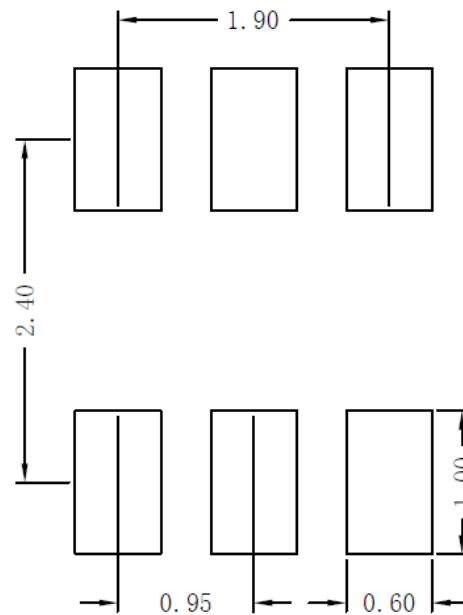

Notes: All dimensions in millimeter and exclude mold flash & metal burr.

Taping & Reel Specification

1. Taping orientation

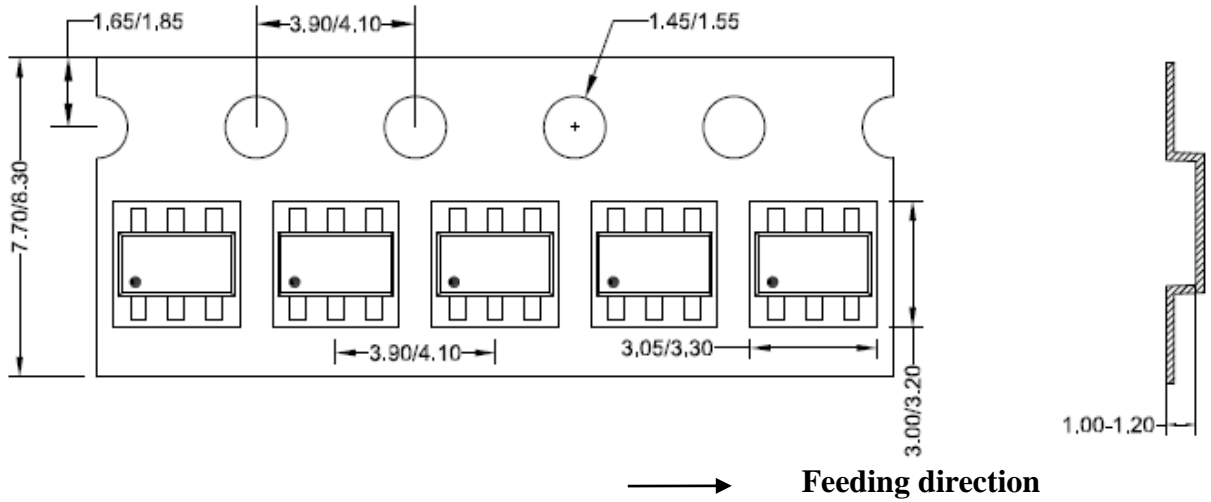

2. Carrier Tape & Reel specification for packages

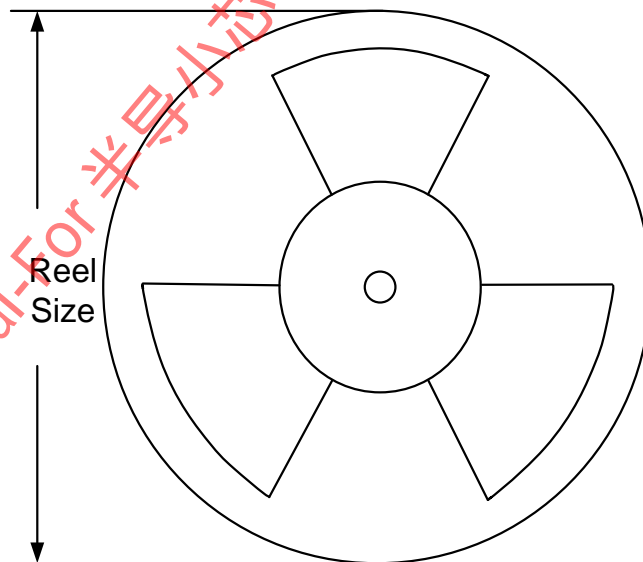

Package types	Tape width (mm)	Pocket pitch(mm)	Reel size (Inch)	Trailer length(mm)	Leader length (mm)	Qty per reel
TSOT23-6	8	4	7	400	160	3000

3. Others: NA

单击下面可查看定价，库存，交付和生命周期等信息

[>>SILERGY\(矽力杰\)](#)