

Features

- Spread spectrum for EMI reduction
 - Wide spread % option
 - Center spread: from $\pm 0.125\%$ to $\pm 2\%$, $\pm 0.125\%$ step size
 - Down spread: -0.25% to -4% with -0.25% step size
 - Spread profile option: Triangular, Hershey-kiss, Random
- Programmable rise/fall time for EMI reduction: 8 options, 0.25 to 40 ns
- AEC-Q100 with extended temperature range (-55°C to 125°C)
- Any frequency between 1 MHz and 150 MHz accurate to 6 decimal places
- 100% pin-to-pin drop-in replacement to quartz-based XO's
- Excellent total frequency stability as low as ± 25 ppm
 - [Contact SiTime](#) for ± 20 ppm option
- Low power consumption of 6.6 mA typical at 1.8 V
- Pin1 modes: Standby, output enable, or spread disable
- LVCMOS output
- Industry-standard packages
 - QFN: $2.0 \times 1.6 \text{ mm}^2$, $2.5 \times 2.0 \text{ mm}^2$, $3.2 \times 2.5 \text{ mm}^2$
- RoHS and REACH compliant, Pb-free, Halogen-free and Antimony-free

Applications

- Rear/Surround view camera
- Driver monitor
- ADAS ECU/CPU
- High speed serial link



Electrical Specifications

Table 1. Electrical Characteristics

All Min and Max limits are specified over temperature and rated operating voltage with 15 pF output load unless otherwise stated. Typical values are at 25°C and 3.3 V supply voltage.

Parameters	Symbol	Min.	Typ.	Max.	Unit	Condition
Frequency Range						
Output Frequency Range	f	1	–	150	MHz	
Frequency Stability and Aging						
Frequency Stability ^[1]	F_stab	-25	–	+25	ppm	Inclusive of initial tolerance at 25°C , 1st year aging at 25°C , and variations over operating temperature, rated power supply voltage. Spread = Off.
		-50	-	+50	ppm	
Operating Temperature Range						
Operating Temperature Range	T_use	-40	–	+85	$^{\circ}\text{C}$	AEC-Q100 Grade 3
		-40	–	+105	$^{\circ}\text{C}$	AEC-Q100 Grade 2
		-40	–	+125	$^{\circ}\text{C}$	AEC-Q100 Grade 1
		-55	–	+125	$^{\circ}\text{C}$	Extended cold AEC-Q100 Grade 1
Supply Voltage and Current Consumption						
Supply Voltage	Vdd	1.62	1.8	1.98	V	
		2.25	2.5	2.75	V	
		2.52	2.8	3.08	V	
		2.7	3.0	3.3	V	
		2.97	3.3	3.63	V	
		2.25	–	3.63	V	
Current Consumption	Idd	–	7.9	9.5	mA	No load condition, f = 148.5 MHz, Vdd = 2.5 V to 3.3 V
		–	6.6	8.0	mA	No load condition, f = 148.5 MHz, Vdd = 1.8 V
OE Disable Current	I_OD	–	5.3	6.5	mA	f = 148.5 MHz, Vdd = 2.5 V to 3.3 V, OE = GND, Output in high-Z state
		–	5.0	6.0	mA	f = 148.5 MHz, Vdd = 1.8 V, OE = GND, Output in high-Z state
Standby Current	I_std	–	2.6	9.0	μA	$\overline{\text{ST}}$ = GND, Vdd = 2.5 V to 3.3 V, Output is weakly pulled down
		–	0.6	5.0	μA	$\overline{\text{ST}}$ = GND, Vdd = 1.8 V, Output is weakly pulled down

Table 1. Electrical Characteristics(continued)

Parameters	Symbol	Min.	Typ.	Max.	Unit	Condition
LVC MOS Output Characteristics						
Duty Cycle	DC	45	–	55	%	f = 1 to 137 MHz
		43	–	57	%	f = 137.000001 to 150 MHz
Rise/Fall Time	T _r , T _f	–	1.2	2.0	ns	20% - 80%, default derive strength
Output High Voltage	VOH	90%	–	–	V _{dd}	IOH = -4 mA (V _{dd} = 3.0 V or 3.3 V) IOH = -3 mA (V _{dd} = 2.8 V and V _{dd} = 2.5 V) IOH = -2 mA (V _{dd} = 1.8 V)
Output Low Voltage	VOL	–	–	10%	V _{dd}	IOL = 4 mA (V _{dd} = 3.0 V or 3.3 V) IOL = 3 mA (V _{dd} = 2.8 V and V _{dd} = 2.5 V) IOL = 2 mA (V _{dd} = 1.8 V)
Input Characteristics						
Input High Voltage	V _{IH}	70%	–	–	V _{dd}	Pin 1, OE or \overline{ST}
Input Low Voltage	V _{IL}	–	–	30%	V _{dd}	Pin 1, OE or \overline{ST}
Input Leakage Current	IL	–	-2.3	–	μA	Pin1, \overline{ST} logic low
		–	2.8	–	μA	Pin1, \overline{ST} logic high
		–	-24.6	–	μA	Pin1, OE / SD logic low
		–	3.2	–	μA	Pin1, OE / SD logic high
Startup and Resume Timing						
Startup Time	T _{start}	–	–	10	ms	Measured from the time V _{dd} reaches its rated minimum value
Enable/Disable Time	T _{oe}	–	–	215	ns	f = 148.5 MHz. For other frequencies, T _{oe} = 100 ns + 3 * cycles
Resume Time	T _{resume}	–	–	10	ms	Measured from the time ST pin crosses 50% threshold
Spread Enable Time	T _{sde}	–	–	4	μs	Measured from the time SD pin crosses 50% threshold
Spread Disable Time	T _{sdde}	–	–	55	μs	Measured from the time SD pin crosses 50% threshold
Jitter						
Cycle-to-cycle jitter	T _{ccj}	–	10.5	–	ps	f = 148.5 MHz, V _{dd} = 2.5 to 3.3 V, Spread = ON (or OFF)
		–	10.8	–	ps	f = 148.5 MHz, V _{dd} = 1.8 V, Spread = ON (or OFF)

Note:

1. Contact SiTime for ±20 ppm option.

Table 2. Spread Spectrum %^[3]

Ordering Code	Center Spread (%)	Down Spread (%)
A	±0.125	-0.25
B	±0.250	-0.50
C	±0.390	-0.78
D	±0.515	-1.04
E	±0.640	-1.29
F	±0.765	-1.55
G	±0.905	-1.84
H	±1.030	-2.10
I	±1.155	-2.36
J	±1.280	-2.62
K	±1.420	-2.91
L	±1.545	-3.18
M	±1.670	-3.45
N	±1.795	-3.71
O	±1.935	-4.01
P	±2.060	-4.28

Table 3. Spread Profile^[2,3]

Spread Profile
Triangular
Hershey-kiss
Random

Notes:

2. In both Triangular and Hershey-kiss profiles, modulation rate is employed with a frequency of ~31.25 kHz. In random profile, modulation rate is ~ 8.6 kHz.
3. The random profile supports up to ±1.030% center spread or -2.10% down spread (ordering codes A through H).

Table 4. Pin Description

Pin	Symbol	Functionality	
1	OE/ $\overline{\text{ST}}$ / NC/SD	Output Enable	H ^[4] : specified frequency output L: output is high impedance. Only output driver is disabled.
		Standby	H ^[4] : specified frequency output L: output is low (weak pull down). Device goes to sleep mode. Supply current reduced to I _{std} .
		No Connect	Pin1 has no function (Any voltage between 0 and Vdd or Open)
		Spread Disable	H: Spread = ON L: Spread = OFF
2	GND	Power	Electrical ground
3	OUT	Output	Oscillator output
4	VDD	Power	Power supply voltage ^[5]

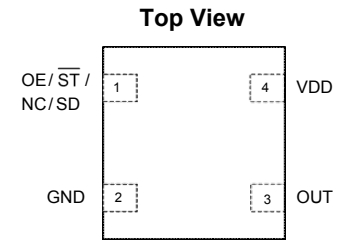

Figure 1. Pin Assignments

Notes:

- In OE or $\overline{\text{ST}}$ mode, a pull-up resistor of 10 k Ω or less is recommended if pin 1 is not externally driven. If pin 1 needs to be left floating, use the NC option.
- A capacitor of value 0.1 μF or higher between Vdd and GND is required.

Table 5. Absolute Maximum Limits

Attempted operation outside the absolute maximum ratings may cause permanent damage to the part. Actual performance of the IC is only guaranteed within the operational specifications, not at absolute maximum ratings.

Parameter	Min.	Max.	Unit
Storage Temperature	-65	150	$^{\circ}\text{C}$
Vdd	-0.5	4	V
Electrostatic Discharge	–	2000	V
Soldering Temperature (follow standard Pb free soldering guidelines)	–	260	$^{\circ}\text{C}$
Junction Temperature ^[6]	–	150	$^{\circ}\text{C}$

Note:

- Exceeding this temperature for extended period of time may damage the device.

Table 6. Maximum Operating Junction Temperature^[7]

Max Operating Temperature (ambient)	Maximum Operating Junction Temperature
85 $^{\circ}\text{C}$	95 $^{\circ}\text{C}$
105 $^{\circ}\text{C}$	115 $^{\circ}\text{C}$
125 $^{\circ}\text{C}$	135 $^{\circ}\text{C}$

Note:

- Datasheet specifications are not guaranteed if junction temperature exceeds the maximum operating junction temperature.

Table 7. Environmental Compliance

Parameter	Condition/Test Method
Mechanical Shock	MIL-STD-883F, Method 2002
Mechanical Vibration	MIL-STD-883F, Method 2007
Temperature Cycle	JESD22, Method A104
Solderability	MIL-STD-883F, Method 2003
Moisture Sensitivity Level	MSL1 @ 260 $^{\circ}\text{C}$

Timing Diagrams

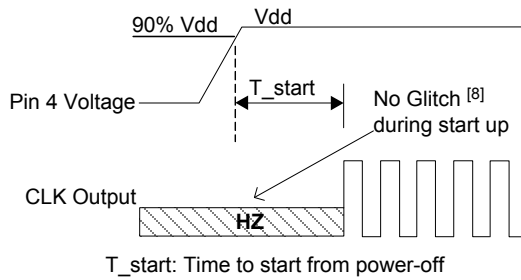

Figure 2. Startup Timing

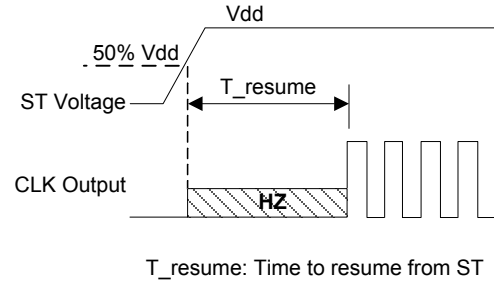

Figure 3. Standby Resume Timing (ST Mode Only)

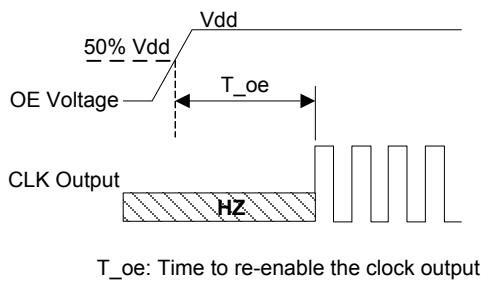

Figure 4. OE Enable Timing (OE Mode Only)

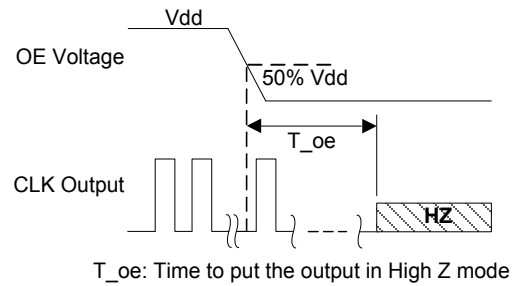

Figure 5. OE Disable Timing (OE Mode Only)

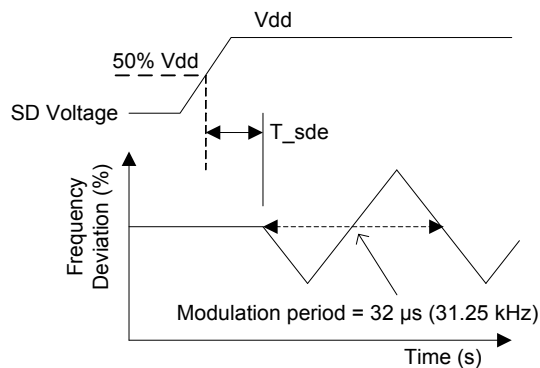

Figure 6. SD Enable Timing (SD Mode Only)

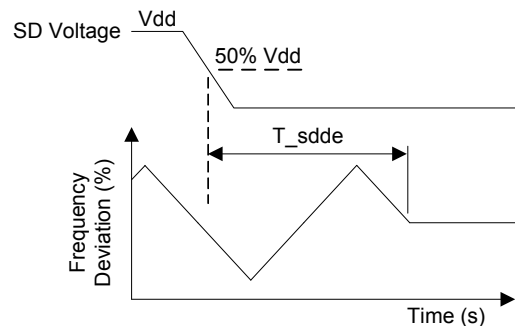

Figure 7. SD Diable Timing (SD Mode Only)

Note:

- 8. SiT9025 has "no runt" pulses and "no glitch" output during startup or resume.

Performance Plots

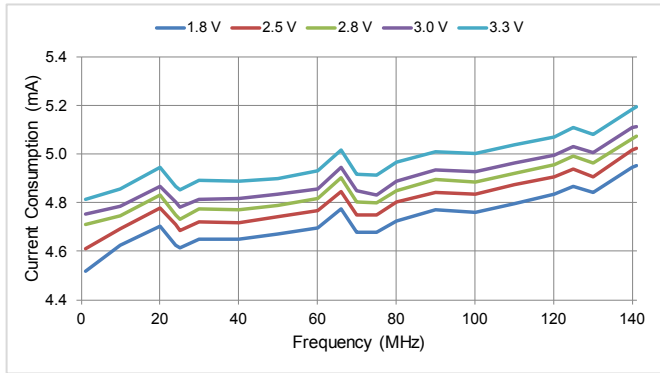

Figure 8. OE Disable Current vs Frequency

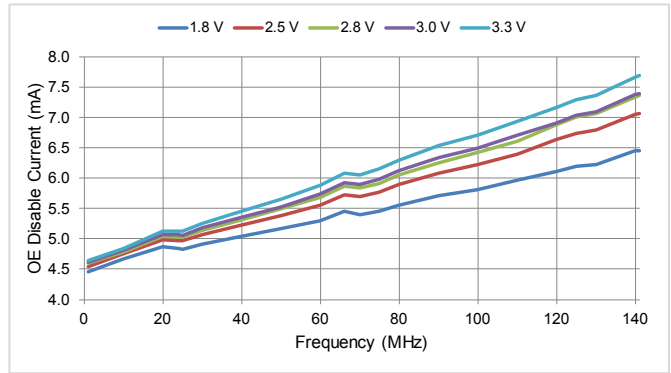

Figure 9. Current Consumption vs Frequency

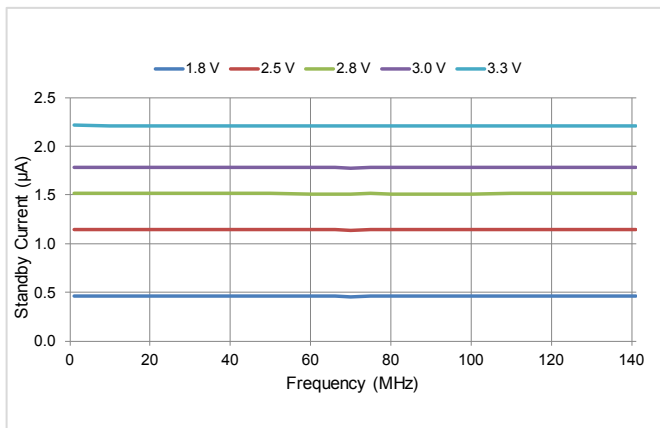

Figure 10. Standby Current vs Frequency

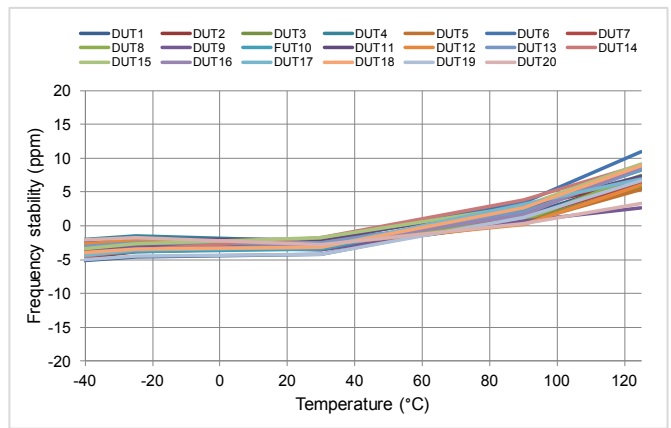

Figure 11. Frequency vs Temperature

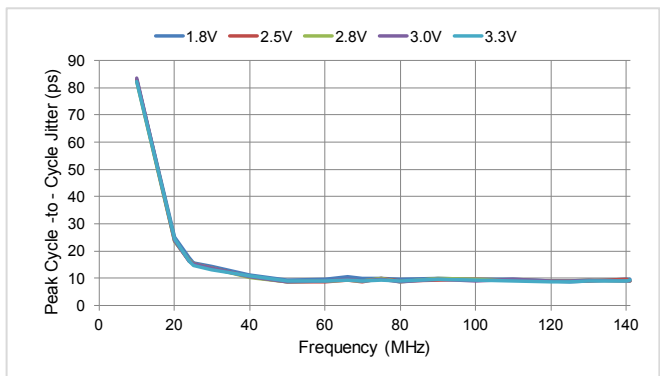

Figure 12. Cycle-to-cycle Jitter vs Frequency
 (Spread profile: Triangular, Spread type: center,
 Spread percentage: $\pm 2.060\%$)

Rise/Fall Time (20% to 80%) vs C_{LOAD} Tables

Table 8. V_{dd} = 1.8 V Rise/Fall Times for Specific C_{LOAD}

Rise/Fall Time Typ (ns)					
Drive Strength \ C _{LOAD}	5 pF	15 pF	30 pF	45 pF	60 pF
L	6.16	11.61	22.00	31.27	39.91
A	3.19	6.35	11.00	16.01	21.52
R	2.11	4.31	7.65	10.77	14.47
B	1.65	3.23	5.79	8.18	11.08
T	0.93	1.91	3.32	4.66	6.48
E	0.78	1.66	2.94	4.09	5.74
U	0.70	1.48	2.64	3.68	5.09
F or "-": default	0.65	1.30	2.40	3.35	4.56

Table 9. V_{dd} = 2.5 V Rise/Fall Times for Specific C_{LOAD}

Rise/Fall Time Typ (ns)					
Drive Strength \ C _{LOAD}	5 pF	15 pF	30 pF	45 pF	60 pF
L	4.13	8.25	12.82	21.45	27.79
A	2.11	4.27	7.64	11.20	14.49
R	1.45	2.81	5.16	7.65	9.88
B	1.09	2.20	3.88	5.86	7.57
T	0.62	1.28	2.27	3.51	4.45
E or "-": default	0.54	1.00	2.01	3.10	4.01
U	0.43	0.96	1.81	2.79	3.65
F	0.34	0.88	1.64	2.54	3.32

Table 10. V_{dd} = 2.8 V Rise/Fall Times for Specific C_{LOAD}

Rise/Fall Time Typ (ns)					
Drive Strength \ C _{LOAD}	5 pF	15 pF	30 pF	45 pF	60 pF
L	3.77	7.54	12.28	19.57	25.27
A	1.94	3.90	7.03	10.24	13.34
R	1.29	2.57	4.72	7.01	9.06
B	0.97	2.00	3.54	5.43	6.93
T	0.55	1.12	2.08	3.22	4.08
E or "-": default	0.44	1.00	1.83	2.82	3.67
U	0.34	0.88	1.64	2.52	3.30
F	0.29	0.81	1.48	2.29	2.99

Table 11. V_{dd} = 3.0 V Rise/Fall Times for Specific C_{LOAD}

Rise/Fall Time Typ (ns)					
Drive Strength \ C _{LOAD}	5 pF	15 pF	30 pF	45 pF	60 pF
L	3.60	7.21	11.97	18.74	24.30
A	1.84	3.71	6.72	9.86	12.68
R	1.22	2.46	4.54	6.76	8.62
B	0.89	1.92	3.39	5.20	6.64
T or "-": default	0.51	1.00	1.97	3.07	3.90
E	0.38	0.92	1.72	2.71	3.51
U	0.30	0.83	1.55	2.40	3.13
F	0.27	0.76	1.39	2.16	2.85

Table 12. V_{dd} = 3.3 V Rise/Fall Times for Specific C_{LOAD}

Rise/Fall Time Typ (ns)					
Drive Strength \ C _{LOAD}	5 pF	15 pF	30 pF	45 pF	60 pF
L	3.39	6.88	11.63	17.56	23.59
A	1.74	3.50	6.38	8.98	12.19
R	1.16	2.33	4.29	6.04	8.34
B	0.81	1.82	3.22	4.52	6.33
T or "-": default	0.46	1.00	1.86	2.60	3.84
E	0.33	0.87	1.64	2.30	3.35
U	0.28	0.79	1.46	2.05	2.93
F	0.25	0.72	1.31	1.83	2.61

Programmable Drive Strength

The SiT9025 includes a programmable drive strength feature to provide a simple, flexible tool to optimize the clock rise/fall time for specific applications. Benefits from the programmable drive strength feature are:

- Improves system radiated electromagnetic interference (EMI) by slowing down the clock rise/fall time.
- Improves the downstream clock receiver's (RX) jitter by decreasing (speeding up) the clock rise/fall time.
- Ability to drive large capacitive loads while maintaining full swing with sharp edge rates.

For more detailed information about rise/fall time control and drive strength selection, see the [SiTime Application Notes section](#).

EMI Reduction by Slowing Rise/Fall Time

Figure 13 shows the harmonic power reduction as the rise/fall times are increased (slowed down). The rise/fall times are expressed as a ratio of the clock period. For the ratio of 0.05, the signal is very close to a square wave. For the ratio of 0.45, the rise/fall times are very close to near-triangular waveform. These results, for example, show that the 11th clock harmonic can be reduced by 35 dB if the rise/fall edge is increased from 5% of the period to 45% of the period.

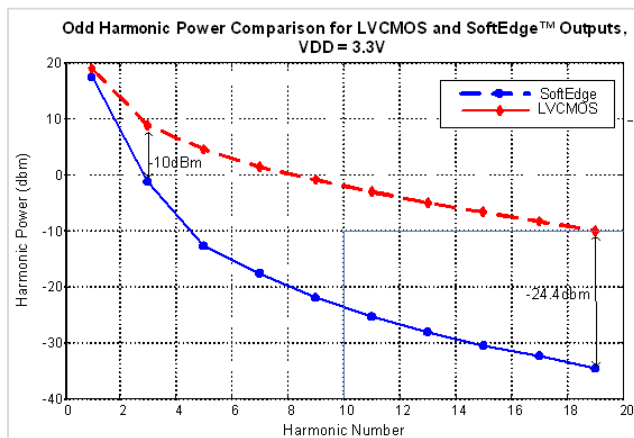

Figure 13. Harmonic EMI reduction as a function of slower rise/fall time

Jitter Reduction with Faster Rise/Fall Time

Power supply noise can be a source of jitter for the downstream chipset. One way to reduce this jitter is to increase rise/fall time (edge rate) of the input clock. Some chipsets would require faster rise/fall time in order to reduce their sensitivity to this type of jitter. The SiT9025 provides up to 3 additional high drive strength settings for very fast rise/fall time. Refer to the [Rise/Fall Time Tables](#) to determine the proper drive strength.

High Output Load Capability

The rise/fall time of the input clock varies as a function of the actual capacitive load the clock drives. At any given drive strength, the rise/fall time becomes slower as the

output load increases. As an example, for a 3.3 V SiT9025 device with default drive strength setting, the typical rise/fall time is 1.1 ns for 15 pF output load. The typical rise/fall time slows down to 2.9 ns when the output load increases to 45 pF. One can choose to speed up the rise/fall time to 1.9 ns by then increasing the drive strength setting on the SiT9025.

The SiT9025 can support up to 60 pF or higher in maximum capacitive loads with up to 3 additional drive strength settings. Refer to the [Rise/Fall Time Tables](#) to determine the proper drive strength for the desired combination of output load vs. rise/fall time.

SiT9025 Drive Strength Selection

Tables 8 through 12 define the rise/fall time for a given capacitive load and supply voltage.

1. Select the table that matches the SiT9025 nominal supply voltage (1.8 V, 2.5 V, 2.8 V, 3.3 V).
2. Select the capacitive load column that matches the application requirement (15 pF to 60 pF)
3. Under the capacitive load column, select the desired rise/fall times.
4. The left-most column represents the part number code for the corresponding drive strength.
5. Add the drive strength code to the part number for ordering purposes.

Calculating Maximum Frequency

Based on the rise and fall time data given in Tables 8 through 12, the maximum frequency the oscillator can operate with guaranteed full swing of the output voltage over temperature as follows:

$$\text{Max Frequency} = \frac{1}{5 \times \text{Trf}_{20/80}}$$

where $\text{Trf}_{20/80}$ is the typical value for 20%-80% rise/fall time.

Example 1

Calculate f_{MAX} for the following condition:

- Vdd = 1.8 V ([Table 8](#))
- Capacitive Load: 30 pF
- Desired Tr/f time = 3 ns (rise/fall time part number code = E)

Part number for the above example:

SiT9025AAE12-18E-66.666660



Drive strength code is inserted here. Default setting is “-”

Supplied Voltage

The supplied voltage must always stay within the range from minimum to maximum limits of rated operating voltage to guarantee specification performance. The supply voltage must drop below 0.6 V for the device to reset.

Dimensions and Patterns

Package Size – Dimensions (Unit: mm) ^[9]	Recommended Land Pattern (Unit: mm) ^[10]																																																																																			
<p>2.0 x 1.6 x 0.75 mm</p> <p>(TOP VIEW) (BOTTOM VIEW) (SIDE VIEW)</p> <table border="1" style="width:100%; border-collapse: collapse;"> <thead> <tr> <th></th> <th>SYMBOL</th> <th>MIN</th> <th>NOM</th> <th>MAX</th> </tr> </thead> <tbody> <tr> <td>PACKAGE THICKNESS</td> <td>A</td> <td>0.700</td> <td>0.750</td> <td>0.800</td> </tr> <tr> <td>STAND OFF</td> <td>A1</td> <td>0.000</td> <td>0.020</td> <td>0.050</td> </tr> <tr> <td rowspan="2">BODY SIZE</td> <td>X</td> <td>D</td> <td>1.600</td> <td>BSC</td> </tr> <tr> <td>Y</td> <td>E</td> <td>2.000</td> <td>BSC</td> </tr> <tr> <td rowspan="2">LEAD WIDTH</td> <td>b</td> <td>0.430</td> <td>0.480</td> <td>0.530</td> </tr> <tr> <td>b1</td> <td>0.230</td> <td>0.280</td> <td>0.330</td> </tr> <tr> <td rowspan="2">LEAD LENGTH</td> <td>L</td> <td>0.580</td> <td>0.680</td> <td>0.780</td> </tr> <tr> <td>L1</td> <td>0.100</td> <td>REF</td> <td></td> </tr> <tr> <td>LEAD PITCH</td> <td>e</td> <td>0.930</td> <td>BSC</td> <td></td> </tr> <tr> <td>RADIUS</td> <td>F</td> <td>0.100</td> <td>REF</td> <td></td> </tr> <tr> <td>PACKAGE TOLERANCE</td> <td>aaa</td> <td>0.050</td> <td></td> <td></td> </tr> <tr> <td>MOLD FLATNESS</td> <td>bbb</td> <td>0.100</td> <td></td> <td></td> </tr> <tr> <td>COPLANARITY</td> <td>ccc</td> <td>0.080</td> <td></td> <td></td> </tr> </tbody> </table> <p>NOTES 1. Dimensioning and tolerance conform to ASME Y14.5-2009 2. All dimensions are in millimeters.</p> <div style="display: flex; justify-content: space-between; align-items: center;"> <table border="1" style="width:80%; border-collapse: collapse;"> <tr> <td>TITLE</td> <td>4L PQFN</td> <td>DWG NO.</td> <td></td> </tr> <tr> <td></td> <td>1.60x2.00x0.75 mm</td> <td>POD-PQFN-004-X01620-026</td> <td></td> </tr> <tr> <td>DATE</td> <td>01-APR-2019</td> <td>REV.</td> <td>SHEET</td> </tr> <tr> <td></td> <td>A02</td> <td></td> <td>1 OF 2</td> </tr> </table> </div>		SYMBOL	MIN	NOM	MAX	PACKAGE THICKNESS	A	0.700	0.750	0.800	STAND OFF	A1	0.000	0.020	0.050	BODY SIZE	X	D	1.600	BSC	Y	E	2.000	BSC	LEAD WIDTH	b	0.430	0.480	0.530	b1	0.230	0.280	0.330	LEAD LENGTH	L	0.580	0.680	0.780	L1	0.100	REF		LEAD PITCH	e	0.930	BSC		RADIUS	F	0.100	REF		PACKAGE TOLERANCE	aaa	0.050			MOLD FLATNESS	bbb	0.100			COPLANARITY	ccc	0.080			TITLE	4L PQFN	DWG NO.			1.60x2.00x0.75 mm	POD-PQFN-004-X01620-026		DATE	01-APR-2019	REV.	SHEET		A02		1 OF 2	
	SYMBOL	MIN	NOM	MAX																																																																																
PACKAGE THICKNESS	A	0.700	0.750	0.800																																																																																
STAND OFF	A1	0.000	0.020	0.050																																																																																
BODY SIZE	X	D	1.600	BSC																																																																																
	Y	E	2.000	BSC																																																																																
LEAD WIDTH	b	0.430	0.480	0.530																																																																																
	b1	0.230	0.280	0.330																																																																																
LEAD LENGTH	L	0.580	0.680	0.780																																																																																
	L1	0.100	REF																																																																																	
LEAD PITCH	e	0.930	BSC																																																																																	
RADIUS	F	0.100	REF																																																																																	
PACKAGE TOLERANCE	aaa	0.050																																																																																		
MOLD FLATNESS	bbb	0.100																																																																																		
COPLANARITY	ccc	0.080																																																																																		
TITLE	4L PQFN	DWG NO.																																																																																		
	1.60x2.00x0.75 mm	POD-PQFN-004-X01620-026																																																																																		
DATE	01-APR-2019	REV.	SHEET																																																																																	
	A02		1 OF 2																																																																																	
<p>2.5 x 2.0 x 0.75 mm</p> <p>(TOP VIEW) (BOTTOM VIEW) (SIDE VIEW)</p> <table border="1" style="width:100%; border-collapse: collapse;"> <thead> <tr> <th></th> <th>SYMBOL</th> <th>MIN</th> <th>NOM</th> <th>MAX</th> </tr> </thead> <tbody> <tr> <td>PACKAGE THICKNESS</td> <td>A</td> <td>0.700</td> <td>0.750</td> <td>0.800</td> </tr> <tr> <td>THICKNESS</td> <td>A1</td> <td>0.000</td> <td>0.020</td> <td>0.050</td> </tr> <tr> <td rowspan="2">BODY SIZE</td> <td>X</td> <td>D</td> <td>2.000</td> <td>BSC</td> </tr> <tr> <td>Y</td> <td>E</td> <td>2.500</td> <td>BSC</td> </tr> <tr> <td>LEAD WIDTH</td> <td>b</td> <td>0.300</td> <td>0.350</td> <td>0.400</td> </tr> <tr> <td>LEAD LENGTH</td> <td>L</td> <td>0.650</td> <td>0.750</td> <td>0.850</td> </tr> <tr> <td>LEAD PITCH</td> <td>e</td> <td>1.250</td> <td>BSC</td> <td></td> </tr> <tr> <td>PACKAGE TOLERANCE</td> <td>aaa</td> <td>0.050</td> <td></td> <td></td> </tr> <tr> <td>MOLD FLATNESS</td> <td>bbb</td> <td>0.100</td> <td></td> <td></td> </tr> <tr> <td>COPLANARITY</td> <td>ccc</td> <td>0.080</td> <td></td> <td></td> </tr> </tbody> </table> <p>NOTES 1. Dimensioning and tolerance conform to ASME Y14.5-2009 2. All dimensions are in millimeters.</p> <div style="display: flex; justify-content: space-between; align-items: center;"> <table border="1" style="width:80%; border-collapse: collapse;"> <tr> <td>TITLE</td> <td>4L PQFN</td> <td>DWG NO.</td> <td></td> </tr> <tr> <td></td> <td>2.00x2.50x0.75 mm</td> <td>POD-PQFN-004-X02025-010</td> <td></td> </tr> <tr> <td>DATE</td> <td>01-APR-2019</td> <td>REV.</td> <td>SHEET</td> </tr> <tr> <td></td> <td>A02</td> <td></td> <td>1 OF 2</td> </tr> </table> </div>		SYMBOL	MIN	NOM	MAX	PACKAGE THICKNESS	A	0.700	0.750	0.800	THICKNESS	A1	0.000	0.020	0.050	BODY SIZE	X	D	2.000	BSC	Y	E	2.500	BSC	LEAD WIDTH	b	0.300	0.350	0.400	LEAD LENGTH	L	0.650	0.750	0.850	LEAD PITCH	e	1.250	BSC		PACKAGE TOLERANCE	aaa	0.050			MOLD FLATNESS	bbb	0.100			COPLANARITY	ccc	0.080			TITLE	4L PQFN	DWG NO.			2.00x2.50x0.75 mm	POD-PQFN-004-X02025-010		DATE	01-APR-2019	REV.	SHEET		A02		1 OF 2														
	SYMBOL	MIN	NOM	MAX																																																																																
PACKAGE THICKNESS	A	0.700	0.750	0.800																																																																																
THICKNESS	A1	0.000	0.020	0.050																																																																																
BODY SIZE	X	D	2.000	BSC																																																																																
	Y	E	2.500	BSC																																																																																
LEAD WIDTH	b	0.300	0.350	0.400																																																																																
LEAD LENGTH	L	0.650	0.750	0.850																																																																																
LEAD PITCH	e	1.250	BSC																																																																																	
PACKAGE TOLERANCE	aaa	0.050																																																																																		
MOLD FLATNESS	bbb	0.100																																																																																		
COPLANARITY	ccc	0.080																																																																																		
TITLE	4L PQFN	DWG NO.																																																																																		
	2.00x2.50x0.75 mm	POD-PQFN-004-X02025-010																																																																																		
DATE	01-APR-2019	REV.	SHEET																																																																																	
	A02		1 OF 2																																																																																	

Dimensions and Patterns

Package Size – Dimensions (Unit: mm) ^[9]				Recommended Land Pattern (Unit: mm) ^[10]																																																																						
<p>3.2 x 2.5 x 0.75 mm</p>				<table border="1" style="width:100%; border-collapse: collapse;"> <thead> <tr> <th></th> <th>SYMBOL</th> <th>MIN</th> <th>NOM</th> <th>MAX</th> </tr> </thead> <tbody> <tr> <td>PACKAGE THICKNESS</td> <td>A</td> <td>0.700</td> <td>0.750</td> <td>0.800</td> </tr> <tr> <td>STAND OFF</td> <td>A1</td> <td>0.000</td> <td>0.020</td> <td>0.050</td> </tr> <tr> <td rowspan="2">BODY SIZE</td> <td>X</td> <td>D</td> <td>2.500</td> <td>BSC</td> </tr> <tr> <td>Y</td> <td>E</td> <td>3.200</td> <td>BSC</td> </tr> <tr> <td>LEAD WIDTH</td> <td>b</td> <td>0.800</td> <td>0.900</td> <td>1.000</td> </tr> <tr> <td rowspan="2">LEAD LENGTH</td> <td>L</td> <td>0.700</td> <td>0.800</td> <td>0.900</td> </tr> <tr> <td>L1</td> <td></td> <td>0.100</td> <td>REF</td> </tr> <tr> <td>LEAD PITCH</td> <td>e</td> <td></td> <td>2.100</td> <td>BSC</td> </tr> <tr> <td rowspan="2">RADIUS</td> <td>F</td> <td></td> <td>0.450</td> <td>REF</td> </tr> <tr> <td>F1</td> <td></td> <td>0.120</td> <td>REF</td> </tr> <tr> <td>PACKAGE TOLERANCE</td> <td>aaa</td> <td></td> <td>0.050</td> <td></td> </tr> <tr> <td>MOLD FLATNESS</td> <td>bbb</td> <td></td> <td>0.100</td> <td></td> </tr> <tr> <td>COPLANARITY</td> <td>ccc</td> <td></td> <td>0.080</td> <td></td> </tr> </tbody> </table> <p>NOTES 1. Dimensioning and tolerance conform to ASME Y14.5-2009 2. All dimensions are in millimeters.</p>					SYMBOL	MIN	NOM	MAX	PACKAGE THICKNESS	A	0.700	0.750	0.800	STAND OFF	A1	0.000	0.020	0.050	BODY SIZE	X	D	2.500	BSC	Y	E	3.200	BSC	LEAD WIDTH	b	0.800	0.900	1.000	LEAD LENGTH	L	0.700	0.800	0.900	L1		0.100	REF	LEAD PITCH	e		2.100	BSC	RADIUS	F		0.450	REF	F1		0.120	REF	PACKAGE TOLERANCE	aaa		0.050		MOLD FLATNESS	bbb		0.100		COPLANARITY	ccc		0.080	
	SYMBOL	MIN	NOM	MAX																																																																						
PACKAGE THICKNESS	A	0.700	0.750	0.800																																																																						
STAND OFF	A1	0.000	0.020	0.050																																																																						
BODY SIZE	X	D	2.500	BSC																																																																						
	Y	E	3.200	BSC																																																																						
LEAD WIDTH	b	0.800	0.900	1.000																																																																						
LEAD LENGTH	L	0.700	0.800	0.900																																																																						
	L1		0.100	REF																																																																						
LEAD PITCH	e		2.100	BSC																																																																						
RADIUS	F		0.450	REF																																																																						
	F1		0.120	REF																																																																						
PACKAGE TOLERANCE	aaa		0.050																																																																							
MOLD FLATNESS	bbb		0.100																																																																							
COPLANARITY	ccc		0.080																																																																							
<table border="1" style="width:100%; border-collapse: collapse;"> <tr> <td>TITLE</td> <td>4L PQFN</td> <td>DWG NO.</td> <td colspan="2">POD-PQFN-004-X03225-002</td> </tr> <tr> <td>DATE</td> <td>01-APR-2019</td> <td>REV.</td> <td>A04</td> <td>SHEET 1 OF 2</td> </tr> </table>				TITLE	4L PQFN	DWG NO.	POD-PQFN-004-X03225-002		DATE	01-APR-2019	REV.	A04	SHEET 1 OF 2																																																													
TITLE	4L PQFN	DWG NO.	POD-PQFN-004-X03225-002																																																																							
DATE	01-APR-2019	REV.	A04	SHEET 1 OF 2																																																																						

Notes:

9. Top marking: Y denotes manufacturing origin and XXXX denotes manufacturing lot number. The value of "Y" will depend on the assembly location of the device.
10. A capacitor of value 0.1 μF or higher between Vdd and GND is required.

Ordering Information

The following part number guide is for reference only. To customize and build an exact part number, use the SiTime [Part Number Generator](#).

SiT9025AA-73-18E A 25.000625D

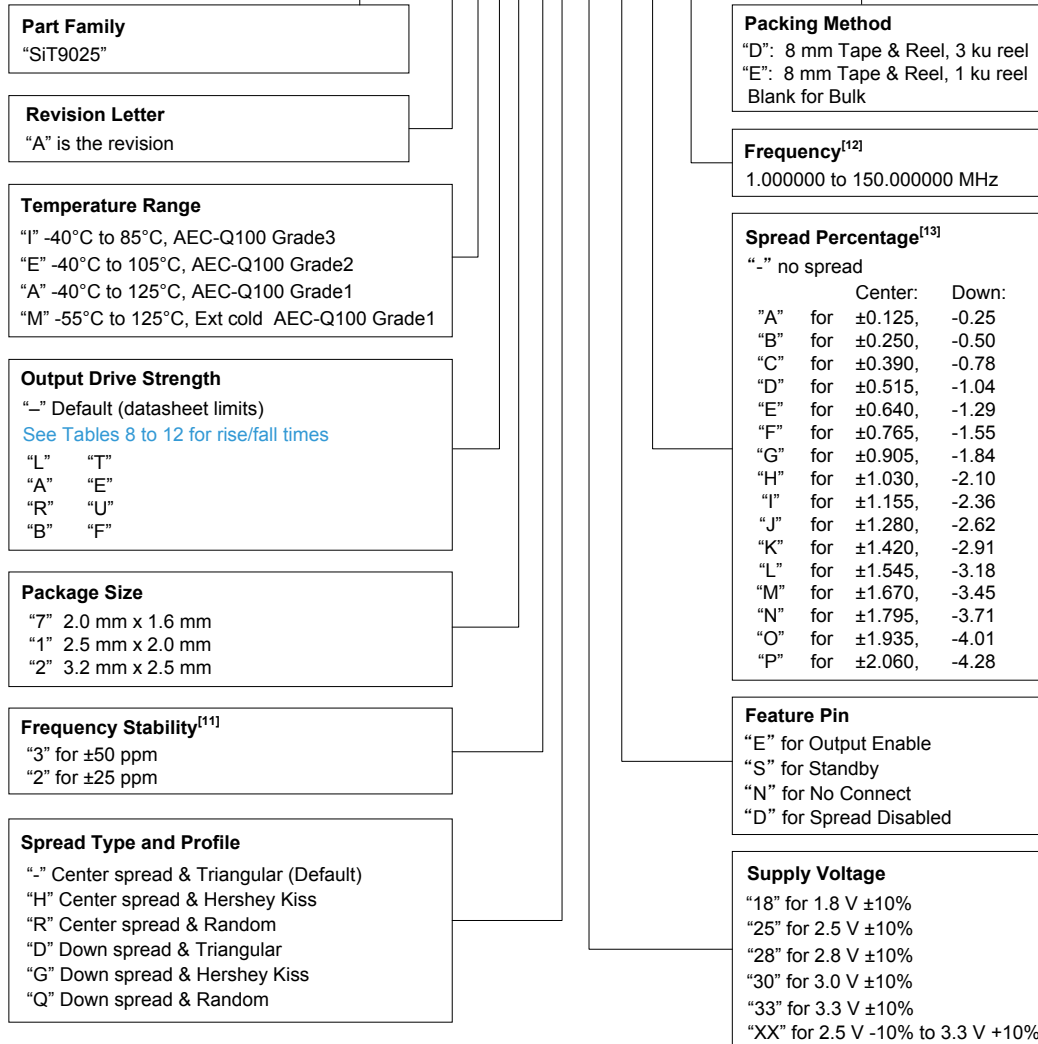

Note:

11. [Contact SiTime](#) for ±20 ppm option.
12. Refer to the [Supported Frequencies](#) tables below.
13. The random profile supports up to ±1.030% center spread or -2.10% down spread (ordering codes A through H).

Supported Frequencies Tables

Table 13. Supported Frequencies
(-40 to +85°C, Center spread)

Spread Percentage (%)	Supported Frequencies (MHz)	
Center spread	Min.	Max.
"A": ±0.125	1.000000	150.00000
"B": ±0.250		
"C": ±0.390		
"D": ±0.515		
"E": ±0.640		
"F": ±0.765		
"G": ±0.905		
"H": ±1.030		
"I": ±1.155		
"J": ±1.280		
"K": ±1.420		
"L": ±1.545		
"M": ±1.670		
"N": ±1.795		
"O": ±1.935		
"P": ±2.060		

Table 14. Supported Frequencies
(-40 to +85°C, Down spread)

Spread Percentage (%)	Supported Frequencies (MHz)	
Down spread	Min.	Max.
"A": -0.25	1.000000	150.00000
"B": -0.50		
"C": -0.78		
"D": -1.04		
"E": -1.29		
"F": -1.55		
"G": -1.84		
"H": -2.10		
"I": -2.36		
"J": -2.62		
"K": -2.91		
"L": -3.18		
"M": -3.45		
"N": -3.71		
"O": -4.01		
"P": -4.28		

Table 15. Supported Frequencies
(-40 to +105°C or -40 to +125°C, Center spread)

Spread Percentage (%)	Supported Frequencies (MHz)	
Center spread	Min.	Max.
"A": ±0.125	1.000000	150.000000
"B": ±0.250		
"C": ±0.390		
"D": ±0.515		
"E": ±0.640		
"F": ±0.765		
"G": ±0.905		
"H": ±1.030		
"I": ±1.155		
"J": ±1.280		
"K": ±1.420	1.000000	149.900000
"L": ±1.545	1.000000	120.100000
	120.700000	149.800000
"M": ±1.670	1.000000	119.900000
	124.500000	149.600000
"N": ±1.795	1.000000	100.100000
	102.700000	119.600000
	128.400000	149.300000
"O": ±1.935	1.000000	85.800000
	86.100000	100.100000
	103.400000	119.400000
	129.200000	149.100000
"P": ±2.060	1.000000	74.500000
	75.800000	85.400000
	88.500000	99.300000
	106.200000	119.200000
	132.700000	148.900000

Table 16. Supported Frequencies
(-40 to +105°C or -40 to +125°C, Down spread)

Spread Percentage (%)	Supported Frequencies (MHz)	
Down spread	Min.	Max.
"A": -0.25	1.000000	150.000000
"B": -0.50		
"C": -0.78		
"D": -1.04		
"E": -1.29		
"F": -1.55		
"G": -1.84		
"H": -2.10		
"I": -2.36		
"J": -2.62		
"K": -2.91		
"L": -3.18		
"M": -3.45		
"N": -3.71	1.000000	120.100000
	123.200000	150.000000
"O": -4.01	1.000000	100.100000
	101.600000	120.100000
	127.000000	150.000000
"P": -4.28	1.000000	85.800000
	87.400000	100.100000
	102.400000	102.900000
	104.800000	120.100000
	128.100000	128.600000
	131.100000	150.000000

Table 17. Supported Frequencies
 (-55 to +125°C, Center spread)

Spread Percentage (%)	Supported Frequencies (MHz)	
	Center spread	Min.
"A": ±0.125 "B": ±0.250 "C": ±0.390 "D": ±0.515 "E": ±0.640 "F": ±0.765 "G": ±0.905 "H": ±1.030 "I": ±1.155 "J": ±1.280	1.000000	150.000000
"K": ±1.420	1.000000	120.100000
	120.900000	149.900000
"L": ±1.545	1.000000	120.100000
	124.700000	149.800000
"M": ±1.670	1.000000	100.100000
	102.900000	119.800000
	128.600000	149.600000
"N": ±1.795	1.000000	85.800000
	86.300000	100.100000
	103.500000	119.600000
	129.400000	149.300000
"O": ±1.935	1.000000	74.600000
	75.900000	85.600000
	88.600000	99.500000
	106.300000	119.400000
	132.900000	149.100000
"P": ±2.060	1.000000	60.100000
	60.200000	66.500000
	67.700000	74.500000
	77.400000	85.400000
	90.300000	99.300000
	108.400000	119.100000
	135.500000	148.900000

Table 18. Supported Frequencies
 (-55 to +125°C, Down spread)

Spread Percentage (%)	Supported Frequencies (MHz)	
	Down spread	Min.
"A": -0.25 "B": -0.50 "C": -0.78 "D": -1.04 "E": -1.29 "F": -1.55 "G": -1.84 "H": -2.10 "I": -2.36 "J": -2.62 "K": -2.91 "L": -3.18	1.000000	150.000000
"M": -3.45	1.000000	120.100000
	123.400000	150.000000
"N": -3.71	1.000000	100.100000
	101.800000	120.100000
	127.300000	150.000000
"O": -4.01	1.000000	85.800000
	87.500000	100.100000
	102.600000	102.800000
	105.000000	120.100000
	128.200000	128.500000
"P": -4.28	131.300000	150.000000
	1.000000	75.100000
	75.600000	85.800000
	88.200000	100.100000
	105.800000	120.100000
	132.300000	150.000000

Table 19. Additional information

Document	Description	Download Link
Manufacturing Notes	Tape & Reel dimension, reflow profile and other manufacturing related info	http://www.sitime.com/manufacturing-notes
Qualification Reports	RoHS report, reliability reports, composition reports	http://www.sitime.com/support/quality-and-reliability
Termination Techniques	Termination design recommendations	http://www.sitime.com/support/application-notes
Layout Techniques	Layout recommendations	http://www.sitime.com/support/application-notes

Table 20. Revision history

Version	Release Date	Change Summary
1.0	9-Jun-2020	Final release Formatting updates
1.01	9-Sep-2020	Supply voltage information update Added ± 25 ppm frequency stability Figure 8 and 9 captions fix Changed date format in rev table to d/month/yyyy

SiTime Corporation, 5451 Patrick Henry Drive, Santa Clara, CA 95054, USA | Phone: +1-408-328-4400 | Fax: +1-408-328-4439

© SiTime Corporation 2019-2020. The information contained herein is subject to change at any time without notice. SiTime assumes no responsibility or liability for any loss, damage or defect of a Product which is caused in whole or in part by (i) use of any circuitry other than circuitry embodied in a SiTime product, (ii) misuse or abuse including static discharge, neglect or accident, (iii) unauthorized modification or repairs which have been soldered or altered during assembly and are not capable of being tested by SiTime under its normal test conditions, or (iv) improper installation, storage, handling, warehousing or transportation, or (v) being subjected to unusual physical, thermal, or electrical stress.

Disclaimer: SiTime makes no warranty of any kind, express or implied, with regard to this material, and specifically disclaims any and all express or implied warranties, either in fact or by operation of law, statutory or otherwise, including the implied warranties of merchantability and fitness for use or a particular purpose, and any implied warranty arising from course of dealing or usage of trade, as well as any common-law duties relating to accuracy or lack of negligence, with respect to this material, any SiTime product and any product documentation. Products sold by SiTime are not suitable or intended to be used in a life support application or component, to operate nuclear facilities, or in other mission critical applications where human life may be involved or at stake. All sales are made conditioned upon compliance with the critical uses policy set forth below.

CRITICAL USE EXCLUSION POLICY

BUYER AGREES NOT TO USE SITIME'S PRODUCTS FOR ANY APPLICATION OR IN ANY COMPONENTS USED IN LIFE SUPPORT DEVICES OR TO OPERATE NUCLEAR FACILITIES OR FOR USE IN OTHER MISSION-CRITICAL APPLICATIONS OR COMPONENTS WHERE HUMAN LIFE OR PROPERTY MAY BE AT STAKE.

SiTime owns all rights, title and interest to the intellectual property related to SiTime's products, including any software, firmware, copyright, patent, or trademark. The sale of SiTime products does not convey or imply any license under patent or other rights. SiTime retains the copyright and trademark rights in all documents, catalogs and plans supplied pursuant to or ancillary to the sale of products or services by SiTime. Unless otherwise agreed to in writing by SiTime, any reproduction, modification, translation, compilation, or representation of this material shall be strictly prohibited.

单击下面可查看定价，库存，交付和生命周期等信息

[>>SiTime](#)