



SKYWORKS®

## DATA SHEET

# Si861x/2x Low-Power, Single- and Dual-Channel Digital Isolators

Skyworks' family of ultra-low-power digital isolators are CMOS devices offering substantial data rate, propagation delay, power, size, reliability, and external BOM advantages over legacy isolation technologies. The operating parameters of these products remain stable across wide temperature ranges and throughout device service life for ease of design and highly uniform performance. All device versions have Schmitt trigger inputs for high noise immunity and only require VDD bypass capacitors.

Data rates up to 150 Mbps are supported, and all devices achieve propagation delays of less than 10 ns.

Ordering options include a choice of isolation ratings (2.5, 3.75 and 5 kV) and a selectable fail-safe operating mode to control the default output state during power loss. All products are safety certified by UL, CSA, VDE, and CQC, and products in wide-body packages support reinforced insulation withstanding up to 5 kV<sub>RMS</sub>.

Automotive Grade is available for certain part numbers. These products are built using automotive-specific flows at all steps in the manufacturing process to ensure the robustness and low defectivity required for automotive applications.

## Industrial Applications

- Industrial automation systems
- Medical electronics
- Isolated switch mode supplies
- Isolated ADC, DAC
- Motor control
- Power inverters
- Communications systems

## Automotive Applications

- Onboard chargers
- Battery management systems
- Charging stations
- Traction inverters
- Hybrid electric vehicles
- Battery electric vehicles

## Safety Regulatory Approvals

- UL 1577 recognized
  - Up to 5000 V<sub>RMS</sub> for one minute
- CSA approval
  - IEC 62368-1, 60601-1 (reinforced insulation)
- VDE certification conformity
  - Si862xxT options certified to reinforced per VDE 0884-10 and 62368-1

- All other options certified to VDE 0884-10 (basic) and 62368-1 (reinforced)
- CQC certification approval
  - GB4943.1

## Key Features

- High-speed operation
  - DC to 150 Mbps
- No start-up initialization required
- Wide operating supply voltage
  - 2.5–5.5 V
- Up to 5000 V<sub>RMS</sub> isolation
- Reinforced VDE 0884-10, 10 kV surge-capable (Si862xxT)
- 60-year life at rated working voltage
- High electromagnetic immunity
- Ultra low power (typical)
  - 5 V Operation
    - 1.6 mA per channel at 1 Mbps
    - 5.5 mA per channel at 100 Mbps
  - 2.5 V Operation
    - 1.5 mA per channel at 1 Mbps
    - 3.5 mA per channel at 100 Mbps
- Schmitt trigger inputs
- Selectable fail-safe mode
  - Default high or low output (ordering option)
- Precise timing (typical)
  - 10 ns propagation delay
  - 1.5 ns pulse width distortion
  - 0.5 ns channel-channel skew
  - 2 ns propagation delay skew
  - 5 ns minimum pulse width
- Transient immunity 50 kV/μs
- AEC-Q100 qualification
- Wide temperature range
  - -40 to 125 °C
- RoHS-compliant packages
  - WB SOIC-16
  - SOIC-8
- Automotive-grade OPNs available
  - AIAG compliant PPAP documentation support
  - IMDS and CAMDS listing support



Skyworks Green™ products are compliant with all applicable legislation and are halogen-free. For additional information, refer to *Skyworks Definition of Green™*, document number SQ04-0074.

1. Pin Descriptions (WB SOIC-16)

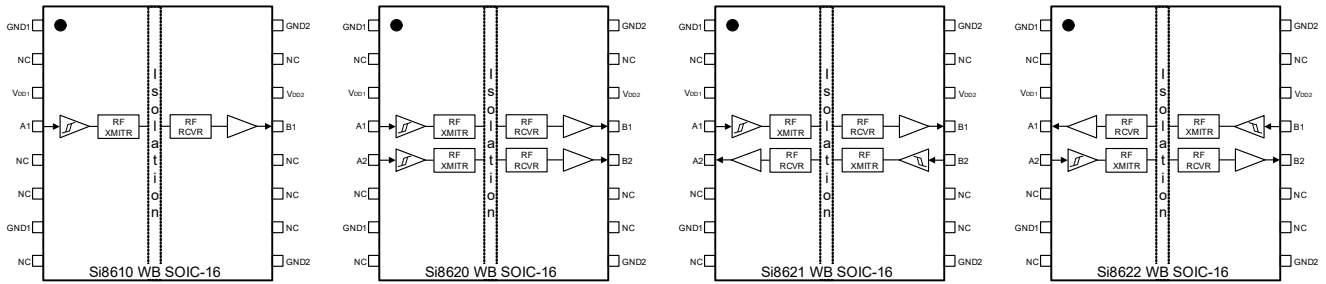

Table 1. WB SOIC-16 Pin Descriptions

Name	WB SOIC-16 Pin# Si8610	WB SOIC-16 Pin# Si862x	Type	Description
GND1	1	1	Ground	Side 1 ground.
NC <sup>1</sup>	2, 5, 6, 8,10, 11, 12, 15	2, 6, 8,10, 11, 15	No Connect	NC
V <sub>DD1</sub>	3	3	Supply	Side 1 power supply.
A1	4	4	Digital I/O	Side 1 digital input or output.
A2	NC	5	Digital I/O	Side 1 digital input or output.
GND1	7	7	Ground	Side 1 ground.
GND2	9	9	Ground	Side 2 ground.
B2	NC	12	Digital I/O	Side 2 digital input or output.
B1	13	13	Digital I/O	Side 2 digital input or output.
V <sub>DD2</sub>	14	14	Supply	Side 2 power supply.
GND2	16	16	Ground	Side 2 ground.

1. No Connect. These pins are not internally connected. They can be left floating, tied to VDD, or tied to GND.

## 2. Pin Descriptions (SOIC-8)

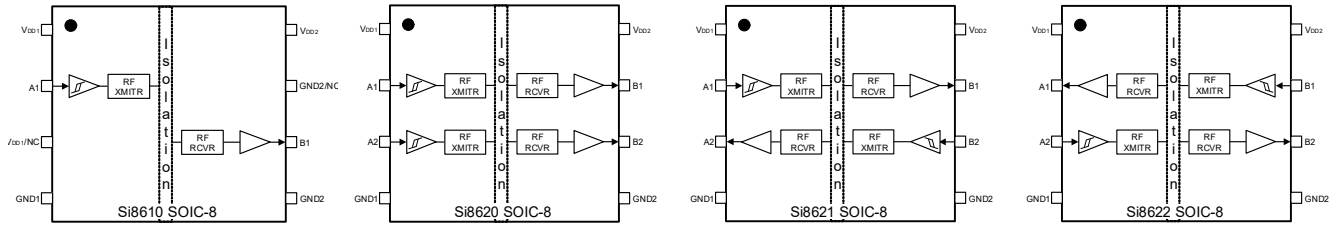

Table 2. NB SOIC-8 Pin Descriptions

Name	SOIC-8 Pin# Si861x	SOIC-8 Pin# Si862x	Type	Description
V <sub>DD1</sub> /NC <sup>1</sup>	1, 3	1	Supply	Side 1 power supply.
GND1	4	4	Ground	Side 1 ground.
A1	2	2	Digital I/O	Side 1 digital input or output.
A2	NA	3	Digital I/O	Side 1 digital input or output.
B1	6	7	Digital I/O	Side 2 digital input or output.
B2	NA	6	Digital I/O	Side 2 digital input or output.
V <sub>DD2</sub>	8	8	Supply	Side 2 power supply.
GND2/NC <sup>1</sup>	5,7	5	Ground	Side 2 ground.

1. No connect. These pins are not internally connected. They can be left floating, tied to VDD, or tied to GND.

### 3. System Overview

#### 3.1. Theory of Operation

The operation of an Si861x/2x channel is analogous to that of an opto coupler, except an RF carrier is modulated instead of light. This simple architecture provides a robust isolated data path and requires no special considerations or initialization at start-up. A simplified block diagram for a single Si861x/2x channel is shown in Figure 1.

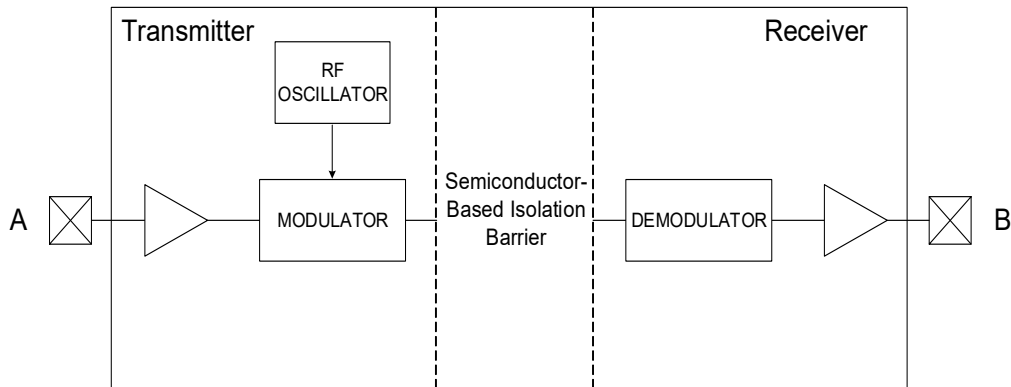

Figure 1. Simplified Channel Diagram

A channel consists of an RF Transmitter and RF Receiver separated by a semiconductor-based isolation barrier. Referring to the transmitter, input A modulates the carrier provided by an RF oscillator using on/off keying. The Receiver contains a demodulator that decodes the input state according to its RF energy content and applies the result to output B via the output driver. This RF on/off keying scheme is superior to pulse code schemes as it provides best-in-class noise immunity, low power consumption, and improved immunity to magnetic fields. See Figure 2 for more details.

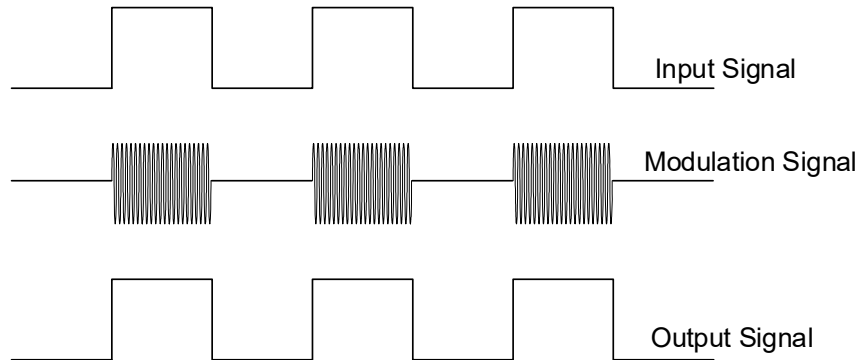

Figure 2. Modulation Scheme

### 3.2. Eye Diagram

Figure 3 illustrates an eye diagram taken on an Si8610. For the data source, the test used an Anritsu (MP1763C) Pulse Pattern Generator set to 1000 ns/div. The output of the generator's clock and data from an Si8610 were captured on an oscilloscope. The results illustrate that data integrity was maintained even at the high data rate of 150 Mbps. The results also show that 2 ns pulse width distortion and 350 ps peak jitter were exhibited.

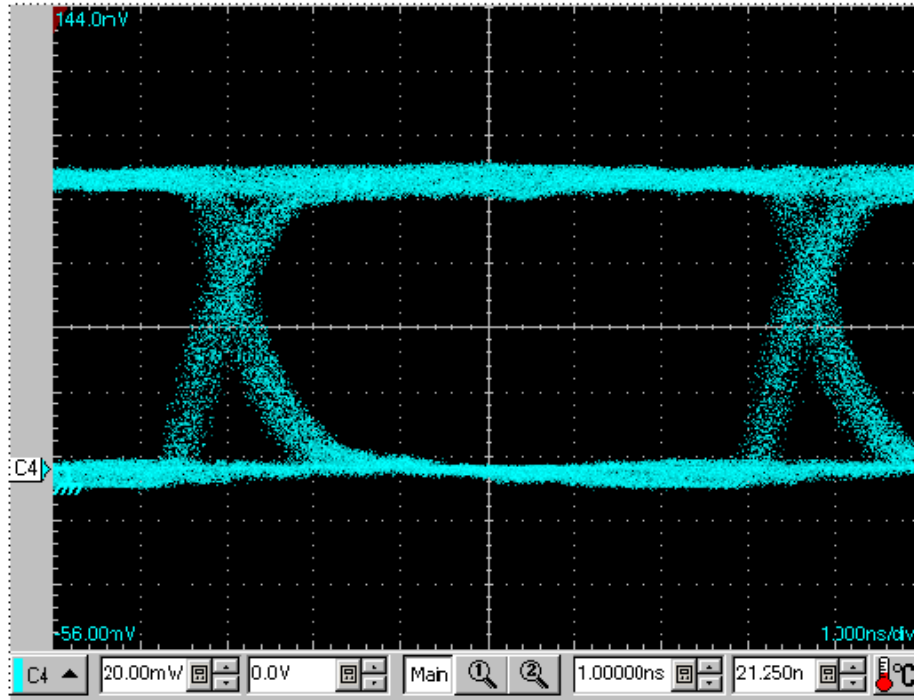

Figure 3. Eye Diagram

### 4. Device Operation

Device behavior during start-up, normal operation, and shutdown is shown in Figure 4, “Device Behavior during Normal Operation,” on page 6, where UVLO+ and UVLO– are the respective positive-going and negative-going thresholds. Refer to Table 3 to determine outputs when power supply (VDD) is not present.

Table 3. Si86xx Logic Operation

V <sub>I</sub> Input <sup>1,2</sup>	VDDI State <sup>1,3,4</sup>	VDDO State <sup>1,3,4</sup>	V <sub>O</sub> Output <sup>1,2</sup>	Comments
H	P	P	H	Normal operation.
L	P	P	L	
X <sup>5</sup>	UP	P	L <sup>6</sup> H <sup>6</sup>	Upon transition of VDDI from unpowered to powered, V <sub>O</sub> returns to the same state as V <sub>I</sub> in less than 1 μs.
X <sup>5</sup>	P	UP	Undetermined	Upon transition of VDDO from unpowered to powered, V <sub>O</sub> returns to the same state as V <sub>I</sub> within 1 μs.

- VDDI and VDDO are the input and output power supplies. V<sub>I</sub> and V<sub>O</sub> are the respective input and output terminals.
- X = not applicable; H = Logic High; L = Logic Low; Hi-Z = High Impedance.
- “Powered” state (P) is defined as 2.5 V < VDD < 5.5 V.
- “Unpowered” state (UP) is defined as VDD = 0 V.
- Note that an I/O can power the die for a given side through an internal diode if its source has adequate current.
- See “1. Ordering Guide” on page 2 for details. This is the selectable fail-safe operating mode (ordering option). Some devices have default output state = H, and some have default output state = L, depending on the ordering part number (OPN). For default high devices, the data channels have pull-ups on inputs/outputs. For default low devices, the data channels have pull-downs on inputs/outputs.

#### 4.1. Device Startup

Outputs are held low during powerup until VDD is above the UVLO threshold for time period t<sub>START</sub>. Following this, the outputs follow the states of inputs.

#### 4.2. Undervoltage Lockout

Undervoltage Lockout (UVLO) is provided to prevent erroneous operation during device startup and shutdown or when VDD is below its specified operating circuits range. Both Side A and Side B each have their own undervoltage lockout monitors. Each side can enter or exit UVLO independently. For example, Side A unconditionally enters UVLO when V<sub>DD1</sub> falls below V<sub>DD1(UVLO–)</sub> and exits UVLO when V<sub>DD1</sub> rises above V<sub>DD1(UVLO+)</sub>. Side B operates the same as Side A with respect to its V<sub>DD2</sub> supply.

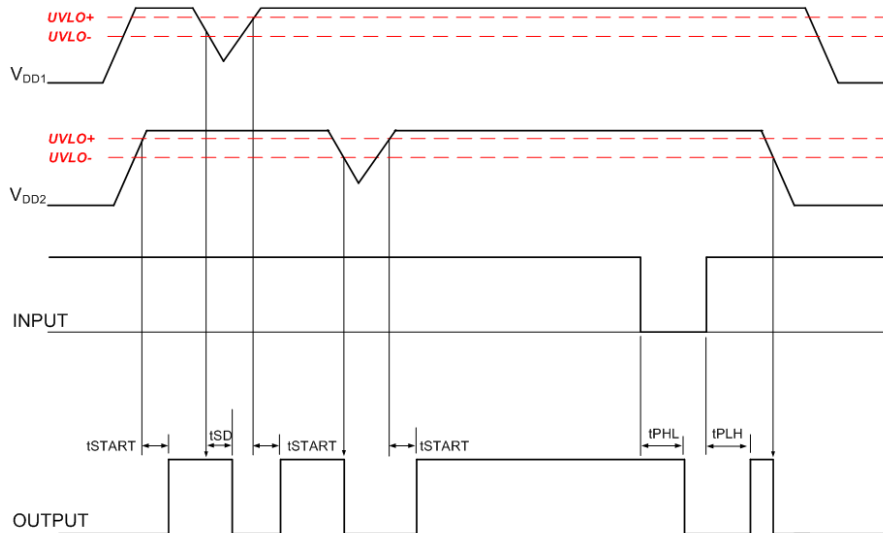

Figure 4. Device Behavior during Normal Operation

### 4.3. Layout Recommendations

To ensure safety in the end-user application, high-voltage circuits (i.e., circuits with  $>30 V_{AC}$ ) must be physically separated from the safety extra-low-voltage circuits (SELV is a circuit with  $<30 V_{AC}$ ) by a certain distance (creepage/clearance). If a component, such as a digital isolator, straddles this isolation barrier, it must meet those creepage/clearance requirements and also provide a sufficiently large high-voltage breakdown protection rating (commonly referred to as working voltage protection). Table 8, “Insulation and Safety-Related Specifications,” on page 18 and Table 10, “VDE 0884-10 Insulation Characteristics,” on page 18 detail the working voltage and creepage/clearance capabilities of the Si86xx. These tables also detail the component standards (UL1577, IEC60747-17), which are readily accepted by certification bodies to provide proof for end-system specifications requirements. Refer to the end-system specification (61010-1, 62368-1, 60601-1, etc.) requirements before starting any design that uses a digital isolator.

#### 4.3.1. Supply Bypass

The Si861x/2x family requires a 0.1  $\mu\text{F}$  bypass capacitor between  $V_{DD1}$  and GND1 and  $V_{DD2}$  and GND2. The capacitor should be placed as close as possible to the package. To enhance the robustness of a design, the user may also include resistors (50–300  $\Omega$ ) in series with the inputs and outputs if the system is excessively noisy.

#### 4.3.2. Output Pin Termination

The nominal output impedance of an isolator driver channel is approximately 50  $\Omega$ ,  $\pm 40\%$ , which is a combination of the value of the on-chip series termination resistor and channel resistance of the output driver FET. When driving loads where transmission line effects will be a factor, output pins should be appropriately terminated with controlled impedance PCB traces.

### 4.4. Fail-Safe Operating Mode

Si86xx devices feature a selectable (by ordering option) mode whereby the default output state (when the input supply is unpowered) can either be a logic high or logic low when the output supply is powered. See “13. Ordering Guide” on page 27 and Table 3, “Si86xx Logic Operation,” on page 6 for more information.

4.5. Typical Performance Characteristics

The typical performance characteristics depicted in the following diagrams are for information purposes only. Refer to “1. Ordering Guide” on page 2 for actual specification limits.

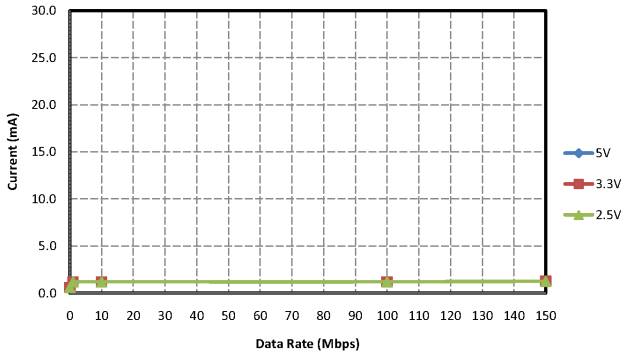

Figure 5. Si8610 Typical  $V_{DD1}$  Supply Current vs. Data Rate 5, 3.3, and 2.5V Operation

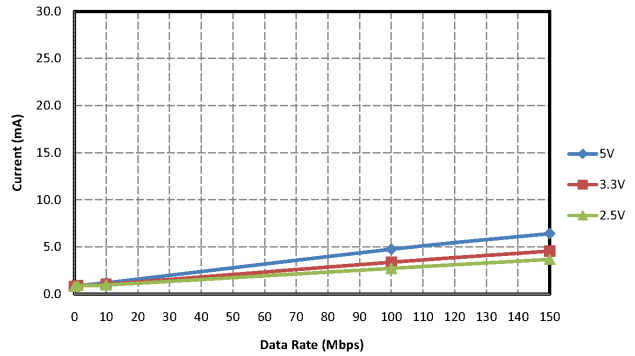

Figure 6. Si8610 Typical  $V_{DD2}$  Supply Current vs. Data Rate 5, 3.3, and 2.5V Operation (15 pF Load)

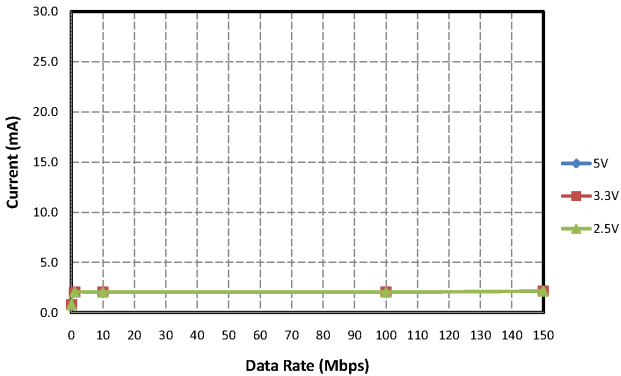

Figure 7. Si8620 Typical  $V_{DD1}$  Supply Current vs. Data Rate 5, 3.3, and 2.5V Operation

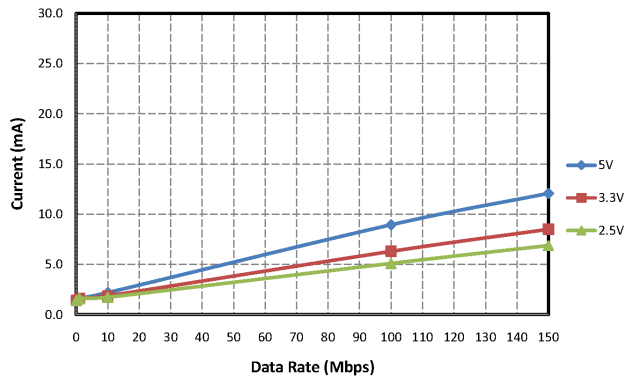

Figure 8. Si8620 Typical  $V_{DD2}$  Supply Current vs. Data Rate 5, 3.3, and 2.5V Operation (15 pF Load)

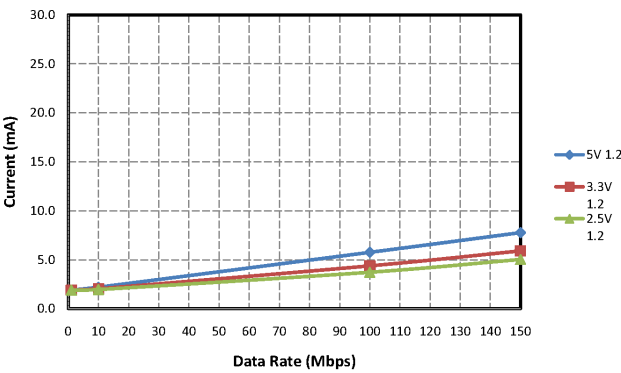

Figure 9. Si8621 Typical  $V_{DD1}$  or  $V_{DD2}$  Supply Current vs. Data Rate 5, 3.3, and 2.5V Operation (15 pF Load)

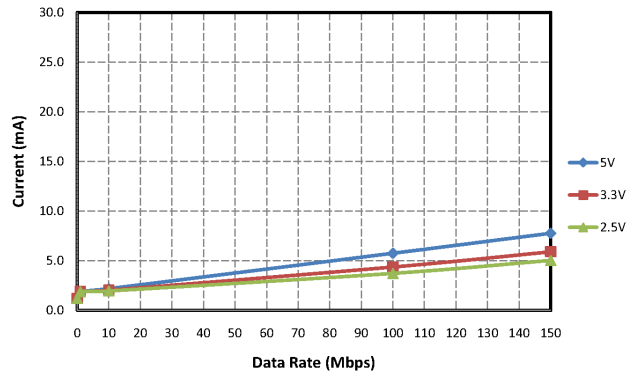

Figure 10. Si8622 Typical  $V_{DD1}$  or  $V_{DD2}$  Supply Current vs. Data Rate 5, 3.3, and 2.5V Operation (15 pF Load)



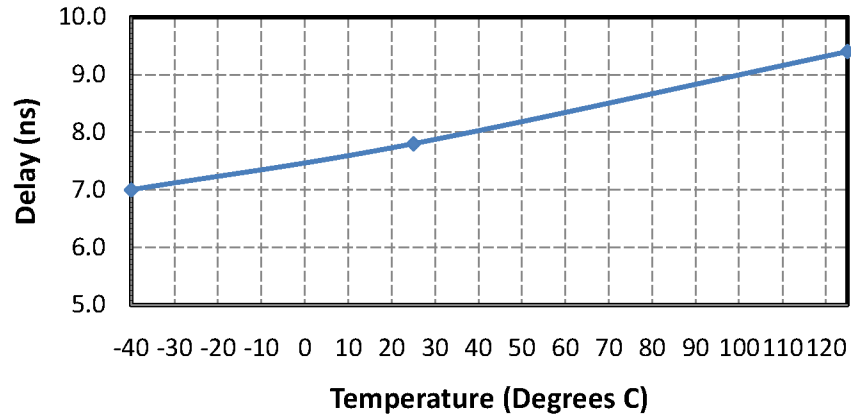

Figure 11. Propagation Delay vs. Temperature (5.0 V Data)

## 5. Electrical Specifications

**Table 4. Absolute Maximum Ratings<sup>1</sup>**

Parameter	Symbol	Min	Max	Unit
Storage temperature <sup>2</sup>	$T_{STG}$	-65	150	°C
Operating temperature	$T_A$	-40	125	°C
Junction temperature	$T_J$	—	150	°C
Supply voltage	$V_{DD1}, V_{DD2}$	-0.5	7.0	V
Input voltage	$V_I$	-0.5	$V_{DD} + 0.5$	V
Output voltage	$V_O$	-0.5	$V_{DD} + 0.5$	V
Output current drive channel	$I_O$	—	10	mA
Lead solder temperature (10 s)		—	260	°C

1. Exposure to maximum rating conditions for extended periods may reduce device reliability. Exceeding any of the limits listed here may result in permanent damage to the device.
2. VDE certifies storage temperature from -40 to 150 °C.

**ESD Handling: Industry-standard ESD handling precautions must be adhered to at all times to avoid damage to this device.**

**Table 5. Recommended Operating Conditions**

Parameter	Symbol	Min	Typ	Max	Unit
Ambient operating temperature <sup>1</sup>	$T_A$	-40	25	125 <sup>1</sup>	°C
Supply voltage	VDD1	2.5	—	5.5	V
	VDD2	2.5	—	5.5	V

1. The maximum ambient temperature is dependent on data frequency, output loading, number of operating channels, and supply voltage.

Table 6. Electrical Characteristics<sup>1</sup>

Parameter	Symbol	Test Condition	Min	Typ	Max	Unit
VDD undervoltage threshold	VDD <sub>UV+</sub>	V <sub>DD1</sub> , V <sub>DD2</sub> rising	1.95	2.24	2.375	V
VDD undervoltage threshold	VDD <sub>UV-</sub>	V <sub>DD1</sub> , V <sub>DD2</sub> falling	1.88	2.16	2.325	V
VDD undervoltage hysteresis	VDD <sub>HYS</sub>		50	70	95	mV
Positive-going input threshold	V <sub>T+</sub>	All inputs rising	1.4	1.67	1.9	V
Negative-going input threshold	V <sub>T-</sub>	All inputs falling	1.0	1.23	1.4	V
Input hysteresis	V <sub>HYS</sub>		0.38	0.44	0.50	V
High level input voltage	V <sub>IH</sub>		2.0	—	—	V
Low level input voltage	V <sub>IL</sub>		—	—	0.8	V
High level output voltage	V <sub>OH</sub>	I <sub>oh</sub> = -4 mA	V <sub>DD1</sub> , V <sub>DD2</sub> - 0.4	4.8	—	V
Low level output voltage	V <sub>OL</sub>	I <sub>ol</sub> = 4 mA	—	0.2	0.4	V
Input leakage current Si86xxxB/C/D Si86xxxT	I <sub>L</sub>		—	—	±10 ±15	µA
Output impedance <sup>2</sup>	Z <sub>O</sub>		—	50	—	Ω
<b>DC Supply Current (All Inputs 0 V or at Supply)</b>						
<b>Si8610Bx, Ex</b> V <sub>DD1</sub> V <sub>DD2</sub> V <sub>DD1</sub> V <sub>DD2</sub>		V <sub>I</sub> = 0(Bx), 1(Ex) V <sub>I</sub> = 0(Bx), 1(Ex) V <sub>I</sub> = 1(Bx), 0(Ex) V <sub>I</sub> = 1(Bx), 0(Ex)	— — — —	0.6 0.8 1.8 0.8	1.2 1.5 2.9 1.5	mA
<b>Si8620Bx, Ex</b> V <sub>DD1</sub> V <sub>DD2</sub> V <sub>DD1</sub> V <sub>DD2</sub>		V <sub>I</sub> = 0(Bx), 1(Ex) V <sub>I</sub> = 0(Bx), 1(Ex) V <sub>I</sub> = 1(Bx), 0(Ex) V <sub>I</sub> = 1(Bx), 0(Ex)	— — — —	0.8 1.4 3.3 1.4	1.4 2.2 5.3 2.2	mA
<b>Si8621Bx, Ex</b> V <sub>DD1</sub> V <sub>DD2</sub> V <sub>DD1</sub> V <sub>DD2</sub>		V <sub>I</sub> = 0(Bx), 1(Ex) V <sub>I</sub> = 0(Bx), 1(Ex) V <sub>I</sub> = 1(Bx), 0(Ex) V <sub>I</sub> = 1(Bx), 0(Ex)	— — — —	1.2 1.2 2.4 2.4	1.9 1.9 3.8 3.8	mA
<b>Si8622Bx, Ex</b> V <sub>DD1</sub> V <sub>DD2</sub> V <sub>DD1</sub> V <sub>DD2</sub>		V <sub>I</sub> = 0(Bx), 1(Ex) V <sub>I</sub> = 0(Bx), 1(Ex) V <sub>I</sub> = 1(Bx), 0(Ex) V <sub>I</sub> = 1(Bx), 0(Ex)	— — — —	2.6 3.3 4.0 4.8	4.2 5.3 6.4 7.7	mA
<b>1 Mbps Supply Current (All Inputs = 500 kHz Square Wave, C<sub>L</sub> = 15 pF on All Outputs)</b>						
<b>Si8610Bx, Ex</b> V <sub>DD1</sub> V <sub>DD2</sub>			— —	1.2 0.9	2.0 1.5	mA
<b>Si8620Bx, Ex</b> V <sub>DD1</sub> V <sub>DD2</sub>			— —	2.1 1.6	3.1 2.4	mA
<b>Si8621Bx, Ex</b> V <sub>DD1</sub> V <sub>DD2</sub>			— —	1.9 1.9	2.9 2.9	mA
<b>Si8622Bx, Ex</b> V <sub>DD1</sub> V <sub>DD2</sub>			— —	3.4 4.2	5.1 6.2	mA

Table 6. Electrical Characteristics<sup>1</sup> (Continued)

Parameter	Symbol	Test Condition	Min	Typ	Max	Unit
<b>10 Mbps Supply Current (All Inputs = 5 MHz Square Wave, C<sub>L</sub> = 15 pF on All Outputs)</b>						
Si8610Bx, Ex V <sub>DD1</sub> V <sub>DD2</sub>			— —	1.2 1.2	2.0 2.0	mA
Si8620Bx, Ex V <sub>DD1</sub> V <sub>DD2</sub>			— —	2.1 2.2	3.1 3.3	mA
Si8621Bx, Ex V <sub>DD1</sub> V <sub>DD2</sub>			— —	2.2 2.2	3.3 3.3	mA
Si8622Bx, Ex V <sub>DD1</sub> V <sub>DD2</sub>			— —	3.7 4.4	5.5 6.7	mA
<b>100 Mbps Supply Current (All Inputs = 50 MHz Square Wave, C<sub>L</sub> = 15 pF on All Outputs)</b>						
Si8610Bx, Ex V <sub>DD1</sub> V <sub>DD2</sub>			— —	1.2 4.8	2.0 6.7	mA
Si8620Bx, Ex V <sub>DD1</sub> V <sub>DD2</sub>			— —	2.1 8.9	3.1 12.5	mA
Si8621Bx, Ex V <sub>DD1</sub> V <sub>DD2</sub>			— —	5.8 5.8	8.1 8.1	mA
Si8622Bx, Ex V <sub>DD1</sub> V <sub>DD2</sub>			— —	7.6 8.2	10.6 11.4	mA
<b>Timing Characteristics</b>						
<b>Si861x/2x Bx, Ex</b>						
Data rate			0	—	150	Mbps
Minimum pulse width			—	—	5.0	ns
Propagation delay	t <sub>PHL</sub> , t <sub>PLH</sub>	See Figure 12, "Propagation Delay Timing," on page 12.	5.0	8.0	13	ns
Pulse Width Distortion  t <sub>PLH</sub> - t <sub>PHL</sub>	PWD	See Figure 12, "Propagation Delay Timing," on page 12.	—	0.2	4.5	ns
Propagation delay skew <sup>3</sup>	t <sub>PSK(P-P)</sub>		—	2.0	4.5	ns
Channel-channel skew	t <sub>PSK</sub>		—	0.4	2.5	ns
<b>All Models</b>						
Output rise time	t <sub>r</sub>	C <sub>L</sub> = 15 pF See Figure 12, "Propagation Delay Timing," on page 12.	—	2.5	4.0	ns
Output fall time	t <sub>f</sub>	C <sub>L</sub> = 15 pF See Figure 12, "Propagation Delay Timing," on page 12.	—	2.5	4.0	ns
Peak eye diagram jitter	t <sub>JIT(PK)</sub>	See Figure 3, "Eye Diagram," on page 5.	—	350	—	ps
Common mode transient immunity Si86xxxB/C/D Si86xxxT	CMTI	V <sub>I</sub> = V <sub>DD</sub> or 0 V V <sub>CM</sub> = 1500 V See Figure 13, "Common-Mode Transient Immunity Test Circuit," on page 12.	35 60	50 100	— —	kV/μs
Start-up time <sup>4</sup>	t <sub>SU</sub>		—	15	40	μs

- V<sub>DD1</sub> = 5 V ±10%; V<sub>DD2</sub> = 5 V ±10%, T<sub>A</sub> = -40 to 125 °C
- The nominal output impedance of an isolator driver channel is approximately 50 Ω, ±40%, which is a combination of the value of the on-chip series termination resistor and channel resistance of the output driver FET. When driving loads where transmission line effects will be a factor, output pins should be appropriately terminated with controlled-impedance PCB traces.
- t<sub>PSK(P-P)</sub> is the magnitude of the difference in propagation delay times measured between different units operating at the same supply voltages, load, and ambient temperature.
- Start-up time is the time period from the application of power to the appearance of valid data at the output.

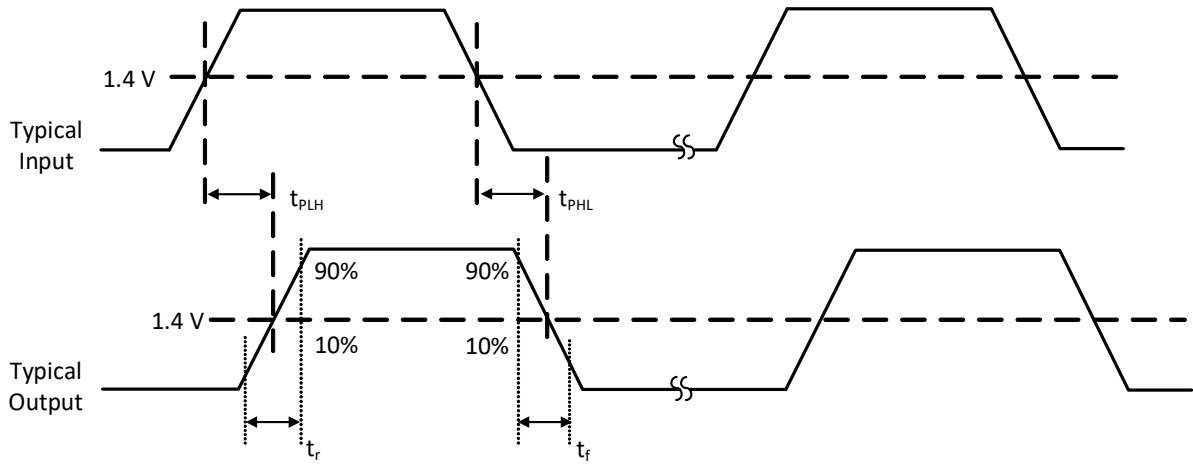

Figure 12. Propagation Delay Timing

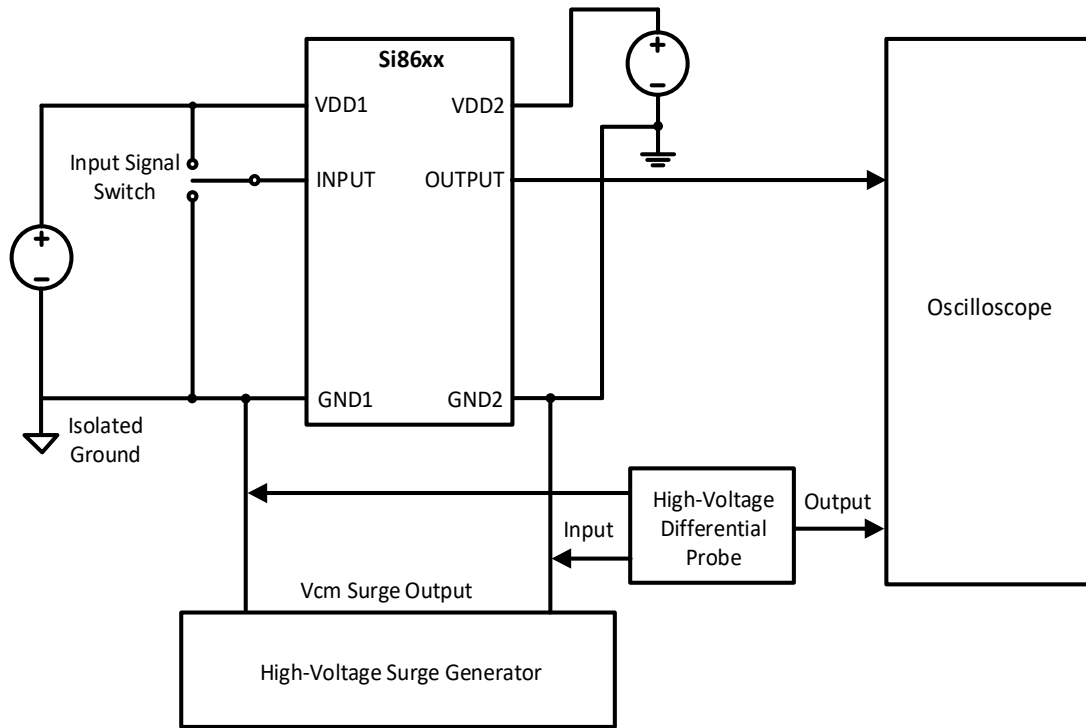

Figure 13. Common-Mode Transient Immunity Test Circuit

Table 7. Electrical Characteristics<sup>1</sup>

Parameter	Symbol	Test Condition	Min	Typ	Max	Unit
VDD undervoltage threshold	VDD <sub>UV+</sub>	V <sub>DD1</sub> , V <sub>DD2</sub> rising	1.95	2.24	2.375	V
VDD undervoltage threshold	VDD <sub>UV-</sub>	V <sub>DD1</sub> , V <sub>DD2</sub> falling	1.88	2.16	2.325	V
VDD undervoltage hysteresis	VDD <sub>HYS</sub>		50	70	95	mV
Positive-going input threshold	VT+	All inputs rising	1.4	1.67	1.9	V
Negative-going input threshold	VT-	All inputs falling	1.0	1.23	1.4	V
Input hysteresis	V <sub>HYS</sub>		0.38	0.44	0.50	V
High level input voltage	V <sub>IH</sub>		2.0	—	—	V
Low level input voltage	V <sub>IL</sub>		—	—	0.8	V
High level output voltage	V <sub>OH</sub>	I <sub>OH</sub> = -4 mA	V <sub>DD1</sub> , V <sub>DD2</sub> - 0.4	3.1	—	V
Low level output voltage	V <sub>OL</sub>	I <sub>OL</sub> = 4 mA	—	0.2	0.4	V
Input leakage current Si86xxxB/C/D Si86xxxT	I <sub>L</sub>		—	—	±10 ±15	µA
Output impedance <sup>2</sup>	Z <sub>O</sub>		—	50	—	Ω
<b>DC Supply Current (All Inputs 0 V or at Supply)</b>						
<b>Si8610Bx, Ex</b> V <sub>DD1</sub> V <sub>DD2</sub> V <sub>DD1</sub> V <sub>DD2</sub>		V <sub>I</sub> = 0(Bx), 1(Ex) V <sub>I</sub> = 0(Bx), 1(Ex) V <sub>I</sub> = 1(Bx), 0(Ex) V <sub>I</sub> = 1(Bx), 0(Ex)	— — — —	0.6 0.8 1.8 0.8	1.2 1.5 2.9 1.5	mA
<b>Si8620Bx, Ex</b> V <sub>DD1</sub> V <sub>DD2</sub> V <sub>DD1</sub> V <sub>DD2</sub>		V <sub>I</sub> = 0(Bx), 1(Ex) V <sub>I</sub> = 0(Bx), 1(Ex) V <sub>I</sub> = 1(Bx), 0(Ex) V <sub>I</sub> = 1(Bx), 0(Ex)	— — — —	0.8 1.4 3.3 1.4	1.4 2.2 5.3 2.2	mA
<b>Si8621Bx, Ex</b> V <sub>DD1</sub> V <sub>DD2</sub> V <sub>DD1</sub> V <sub>DD2</sub>		V <sub>I</sub> = 0(Bx), 1(Ex) V <sub>I</sub> = 0(Bx), 1(Ex) V <sub>I</sub> = 1(Bx), 0(Ex) V <sub>I</sub> = 1(Bx), 0(Ex)	— — — —	1.2 1.2 2.4 2.4	1.9 1.9 3.8 3.8	mA
<b>Si8622Bx, Ex</b> V <sub>DD1</sub> V <sub>DD2</sub> V <sub>DD1</sub> V <sub>DD2</sub>		V <sub>I</sub> = 0(Bx), 1(Ex) V <sub>I</sub> = 0(Bx), 1(Ex) V <sub>I</sub> = 1(Bx), 0(Ex) V <sub>I</sub> = 1(Bx), 0(Ex)	— — — —	2.6 3.3 4.0 4.8	4.2 5.3 6.4 7.7	mA
<b>1 Mbps Supply Current (All Inputs = 500 kHz Square Wave, C<sub>L</sub> = 15 pF on All Outputs)</b>						
<b>Si8610Bx, Ex</b> V <sub>DD1</sub> V <sub>DD2</sub>			— —	1.2 0.9	2.0 1.5	mA
<b>Si8620Bx, Ex</b> V <sub>DD1</sub> V <sub>DD2</sub>			— —	2.1 1.6	3.1 2.4	mA
<b>Si8621Bx, Ex</b> V <sub>DD1</sub> V <sub>DD2</sub>			— —	1.9 1.9	2.9 2.9	mA
<b>Si8622Bx, Ex</b> V <sub>DD1</sub> V <sub>DD2</sub>			— —	3.4 4.2	5.1 6.2	mA

Table 7. Electrical Characteristics<sup>1</sup> (Continued)

Parameter	Symbol	Test Condition	Min	Typ	Max	Unit
<b>10 Mbps Supply Current (All Inputs = 5 MHz Square Wave, C<sub>L</sub> = 15 pF on All Outputs)</b>						
Si8610Bx, Ex V <sub>DD1</sub> V <sub>DD2</sub>			— —	1.2 1.0	2.0 1.8	mA
Si8620Bx, Ex V <sub>DD1</sub> V <sub>DD2</sub>			— —	2.1 1.9	3.1 2.8	mA
Si8621Bx, Ex V <sub>DD1</sub> V <sub>DD2</sub>			— —	2.0 2.0	3.0 3.0	mA
Si8622Bx, Ex V <sub>DD1</sub> V <sub>DD2</sub>			— —	3.5 4.3	5.3 6.4	mA
<b>100 Mbps Supply Current (All Inputs = 50 MHz Square Wave, C<sub>L</sub> = 15 pF on All Outputs)</b>						
Si8610Bx, Ex V <sub>DD1</sub> V <sub>DD2</sub>			— —	1.2 3.4	2.0 5.1	mA
Si8620Bx, Ex V <sub>DD1</sub> V <sub>DD2</sub>			— —	2.1 6.3	3.1 8.8	mA
Si8621Bx, Ex V <sub>DD1</sub> V <sub>DD2</sub>			— —	4.4 4.4	6.1 6.1	mA
Si8622Bx, Ex V <sub>DD1</sub> V <sub>DD2</sub>			— —	5.9 6.6	8.2 9.3	mA
<b>Timing Characteristics</b>						
<b>Si861x/2x Bx, Ex</b>						
Data rate			0	—	150	Mbps
Minimum pulse width			—	—	5.0	ns
Propagation delay	t <sub>PHL</sub> , t <sub>PLH</sub>	See Figure 12, "Propagation Delay Timing," on page 12.	5.0	8.0	13	ns
Pulse width distortion  t <sub>PLH</sub> - t <sub>PHL</sub>	PWD	See Figure 12, "Propagation Delay Timing," on page 12.	—	0.2	4.5	ns
Propagation delay skew <sup>3</sup>	t <sub>PSK(P-P)</sub>		—	2.0	4.5	ns
Channel-channel skew	t <sub>PSK</sub>		—	0.4	2.5	ns
<b>All Models</b>						
Output rise time	t <sub>r</sub>	C <sub>L</sub> = 15 pF See Figure 12, "Propagation Delay Timing," on page 12.	—	2.5	4.0	ns
Output fall time	t <sub>f</sub>	C <sub>L</sub> = 15 pF See Figure 12, "Propagation Delay Timing," on page 12.	—	2.5	4.0	ns
Peak eye diagram jitter	t <sub>JIT(PK)</sub>	See Figure 3, "Eye Diagram," on page 5.	—	350	—	ps
Common mode transient immunity Si86xxxB/C/D Si86xxxT	CMTI	V <sub>I</sub> = V <sub>DD</sub> or 0 V V <sub>CM</sub> = 1500 V See Figure 13, "Common-Mode Transient Immunity Test Circuit," on page 12.	35 60	50 100	— —	kV/μs
Start-up time <sup>4</sup>	t <sub>SU</sub>		—	15	40	μs

- V<sub>DD1</sub> = 3.3 V ±10%; V<sub>DD2</sub> = 3.3 V ±10%, T<sub>A</sub> = -40 to 125 °C
- The nominal output impedance of an isolator driver channel is approximately 50 Ω, ±40%, which is a combination of the value of the on-chip series termination resistor and channel resistance of the output driver FET. When driving loads where transmission line effects will be a factor, output pins should be appropriately terminated with controlled-impedance PCB traces.
- t<sub>PSK(P-P)</sub> is the magnitude of the difference in propagation delay times measured between different units operating at the same supply voltages, load, and ambient temperature.
- Start-up time is the time period from the application of power to the appearance of valid data at the output.

Table 8. Electrical Characteristics<sup>1</sup>

Parameter	Symbol	Test Condition	Min	Typ	Max	Unit
VDD undervoltage threshold	VDD <sub>UV+</sub>	V <sub>DD1</sub> , V <sub>DD2</sub> rising	1.95	2.24	2.375	V
VDD undervoltage threshold	VDD <sub>UV-</sub>	V <sub>DD1</sub> , V <sub>DD2</sub> falling	1.88	2.16	2.325	V
VDD undervoltage hysteresis	VDD <sub>HYS</sub>		50	70	95	mV
Positive-going input threshold	VT+	All inputs rising	1.4	1.67	1.9	V
Negative-going input threshold	VT-	All inputs falling	1.0	1.23	1.4	V
Input hysteresis	V <sub>HYS</sub>		0.38	0.44	0.50	V
High level input voltage	V <sub>IH</sub>		2.0	—	—	V
Low level input voltage	V <sub>IL</sub>		—	—	0.8	V
High level output voltage	V <sub>OH</sub>	I <sub>OH</sub> = -4 mA	V <sub>DD1</sub> , V <sub>DD2</sub> - 0.4	2.3	—	V
Low level output voltage	V <sub>OL</sub>	I <sub>OL</sub> = 4 mA	—	0.2	0.4	V
Input leakage current Si86xxxB/C/D Si86xxxT	I <sub>L</sub>		—	—	±10 ±15	µA
Output impedance <sup>2</sup>	Z <sub>O</sub>		—	50	—	Ω
<b>DC Supply Current (All Inputs 0 V or at Supply)</b>						
<b>Si8610Bx, Ex</b> V <sub>DD1</sub> V <sub>DD2</sub> V <sub>DD1</sub> V <sub>DD2</sub>		V <sub>I</sub> = 0(Bx), 1(Ex) V <sub>I</sub> = 0(Bx), 1(Ex) V <sub>I</sub> = 1(Bx), 0(Ex) V <sub>I</sub> = 1(Bx), 0(Ex)	— — — —	0.6 0.8 1.8 0.8	1.2 1.5 2.9 1.5	mA
<b>Si8620Bx, Ex</b> V <sub>DD1</sub> V <sub>DD2</sub> V <sub>DD1</sub> V <sub>DD2</sub>		V <sub>I</sub> = 0(Bx), 1(Ex) V <sub>I</sub> = 0(Bx), 1(Ex) V <sub>I</sub> = 1(Bx), 0(Ex) V <sub>I</sub> = 1(Bx), 0(Ex)	— — — —	0.8 1.4 3.3 1.4	1.4 2.2 5.3 2.2	mA
<b>Si8621Bx, Ex</b> V <sub>DD1</sub> V <sub>DD2</sub> V <sub>DD1</sub> V <sub>DD2</sub>		V <sub>I</sub> = 0(Bx), 1(Ex) V <sub>I</sub> = 0(Bx), 1(Ex) V <sub>I</sub> = 1(Bx), 0(Ex) V <sub>I</sub> = 1(Bx), 0(Ex)	— — — —	1.2 1.2 2.4 2.4	1.9 1.9 3.8 3.8	mA
<b>Si8622Bx, Ex</b> V <sub>DD1</sub> V <sub>DD2</sub> V <sub>DD1</sub> V <sub>DD2</sub>		V <sub>I</sub> = 0(Bx), 1(Ex) V <sub>I</sub> = 0(Bx), 1(Ex) V <sub>I</sub> = 1(Bx), 0(Ex) V <sub>I</sub> = 1(Bx), 0(Ex)	— — — —	2.6 3.3 4.0 4.8	4.2 5.3 6.4 7.7	mA
<b>1 Mbps Supply Current (All Inputs = 500 kHz Square Wave, C<sub>L</sub> = 15 pF on All Outputs)</b>						
<b>Si8610Bx, Ex</b> V <sub>DD1</sub> V <sub>DD2</sub>			— —	1.2 0.9	2.0 1.5	mA
<b>Si8620Bx, Ex</b> V <sub>DD1</sub> V <sub>DD2</sub>			— —	2.1 1.6	3.1 2.4	mA
<b>Si8621Bx, Ex</b> V <sub>DD1</sub> V <sub>DD2</sub>			— —	1.9 1.9	2.9 2.9	mA
<b>Si8622Bx, Ex</b> V <sub>DD1</sub> V <sub>DD2</sub>			— —	3.4 4.2	5.1 6.2	mA
<b>10 Mbps Supply Current (All Inputs = 5 MHz Square Wave, C<sub>L</sub> = 15 pF on All Outputs)</b>						
<b>Si8610Bx, Ex</b> V <sub>DD1</sub> V <sub>DD2</sub>			— —	1.2 1.0	2.0 1.6	mA
<b>Si8620Bx, Ex</b> V <sub>DD1</sub> V <sub>DD2</sub>			— —	2.1 1.7	3.1 2.6	mA
<b>Si8621Bx, Ex</b> V <sub>DD1</sub> V <sub>DD2</sub>			— —	2.0 2.0	2.9 2.9	mA



Table 8. Electrical Characteristics<sup>1</sup> (Continued)

Parameter	Symbol	Test Condition	Min	Typ	Max	Unit
Si8622Bx, Ex V <sub>DD1</sub> V <sub>DD2</sub>			— —	3.5 4.2	5.2 6.3	mA
<b>100 Mbps Supply Current (All Inputs = 50 MHz Square Wave, C<sub>L</sub> = 15 pF on All Outputs)</b>						
Si8610Bx, Ex V <sub>DD1</sub> V <sub>DD2</sub>			— —	1.2 2.7	2.0 4.4	mA
Si8620Bx, Ex V <sub>DD1</sub> V <sub>DD2</sub>			— —	2.1 5.1	3.1 7.1	mA
Si8621Bx, Ex V <sub>DD1</sub> V <sub>DD2</sub>			— —	3.7 3.7	5.2 5.2	mA
Si8622Bx, Ex V <sub>DD1</sub> V <sub>DD2</sub>			— —	5.2 6.0	7.3 8.4	mA
<b>Timing Characteristics</b>						
<b>Si861x/2x Bx, Ex</b>						
Data rate			0	—	150	Mbps
Minimum pulse width			—	—	5.0	ns
Propagation delay	t <sub>PHL</sub> , t <sub>PLH</sub>	See Figure 12, "Propagation Delay Timing," on page 12.	5.0	8.0	14	ns
Pulse width distortion  t <sub>PLH</sub> - t <sub>PHL</sub>	PWD	See Figure 12, "Propagation Delay Timing," on page 12.	—	0.2	5.0	ns
Propagation delay skew <sup>3</sup>	t <sub>PSK(P-P)</sub>		—	2.0	5.0	ns
Channel-channel skew	t <sub>PSK</sub>		—	0.4	2.5	ns
<b>All Models</b>						
Output rise time	t <sub>r</sub>	C <sub>L</sub> = 15 pF See Figure 12, "Propagation Delay Timing," on page 12.	—	2.5	4.0	ns
Output fall time	t <sub>f</sub>	C <sub>L</sub> = 15 pF See Figure 12, "Propagation Delay Timing," on page 12.	—	2.5	4.0	ns
Peak eye diagram jitter	t <sub>JIT(PK)</sub>	See Figure 3, "Eye Diagram," on page 5.	—	350	—	ps
Common mode transient immunity Si86xxxB/C/D Si86xxxT	CMTI	V <sub>I</sub> = V <sub>DD</sub> or 0 V V <sub>CM</sub> = 1500 V See Figure 13, "Common-Mode Transient Immunity Test Circuit," on page 12.	35 60	50 100	— —	kV/μs
Start-up time <sup>4</sup>	t <sub>SU</sub>		—	15	40	μs

- V<sub>DD1</sub> = 2.5 V ±5%; V<sub>DD2</sub> = 2.5 V ±5%, T<sub>A</sub> = -40 to 125 °C
- The nominal output impedance of an isolator driver channel is approximately 50 Ω, ±40%, which is a combination of the value of the on-chip series termination resistor and channel resistance of the output driver FET. When driving loads where transmission line effects will be a factor, output pins should be appropriately terminated with controlled-impedance PCB traces.
- t<sub>PSK(P-P)</sub> is the magnitude of the difference in propagation delay times measured between different units operating at the same supply voltages, load, and ambient temperature.
- Start-up time is the time period from the application of power to the appearance of valid data at the output.

## 6. Safety Certifications and Specifications

**Table 9. Regulatory Information<sup>1,2,3,4</sup>**

<b>For All Product Options Except Si86xxxT</b>	
<b>CSA</b>	
The Si861x/2x is certified under CSA. For more details, see Master Contract File 232873.	
62368-1: Up to 600 V <sub>RMS</sub> reinforced insulation working voltage; up to 1000 V <sub>RMS</sub> basic insulation working voltage.	
60601-1: Up to 125 V <sub>RMS</sub> reinforced insulation working voltage; up to 380 V <sub>RMS</sub> basic insulation working voltage.	
<b>VDE</b>	
The Si861x/2x is certified according to VDD 0884-10. For more details, see File 5028467.	
VDD 0884-10: Up to 1200 V <sub>peak</sub> for basic insulation working voltage.	
62368-1: Up to 600 V <sub>RMS</sub> reinforced insulation working voltage; up to 1000 V <sub>RMS</sub> basic insulation working voltage.	
<b>UL</b>	
The Si861x/2x is certified under UL1577 component recognition program. For more details, see File E257455.	
Rated up to 5000 V <sub>RMS</sub> isolation voltage for basic protection.	
<b>CQC</b>	
The Si861x/2x is certified under GB4943.1.	
Rated up to 600 V <sub>RMS</sub> reinforced insulation working voltage; up to 1000 V <sub>RMS</sub> basic insulation working voltage.	
For All Si86xxxT Product Options	
<b>CSA</b>	
Certified under CSA. For more details, see Master Contract File 232873.	
62368-1: Up to 600 V <sub>RMS</sub> reinforced insulation working voltage; up to 1000 V <sub>RMS</sub> basic insulation working voltage.	
<b>VDE</b>	
Certified according to VDE 0884-10.	
<b>UL</b>	
Certified under UL1577 component recognition program. For more details, see File E257455.	
Rated up to 5000 V <sub>RMS</sub> isolation voltage for basic protection.	
<b>CQC</b>	
Certified under GB4943.1.	
Rated up to 600 V <sub>RMS</sub> reinforced insulation working voltage; up to 1000 V <sub>RMS</sub> basic insulation working voltage.	

1. Regulatory Certifications apply to 2.5 kV<sub>RMS</sub> rated devices, which are production tested to 3.0 kV<sub>RMS</sub> for 1 s.
2. Regulatory Certifications apply to 3.75 kV<sub>RMS</sub> rated devices, which are production tested to 4.5 kV<sub>RMS</sub> for 1 s.
3. Regulatory Certifications apply to 5.0 kV<sub>RMS</sub> rated devices, which are production tested to 6.0 kV<sub>RMS</sub> for 1 s.
4. For more information, see "1. Ordering Guide" on page 2.

**Table 10. Insulation and Safety-Related Specifications**

Parameter	Symbol	Test Condition	Value		Unit
			WB SOIC-16	SOIC-8	
Nominal external air gap (clearance) <sup>1</sup>	CLR		8.0	4.9	mm
Nominal external tracking (creepage) <sup>1</sup>	CPG		8.0	4.01	mm
Minimum internal gap (internal clearance)	DTI		0.014	0.014	mm
Tracking resistance	PTI or CTI	IEC60112	600	600	V <sub>RMS</sub>
Erosion depth	ED		0.019	0.019	mm
Resistance (input-output) <sup>2</sup>	R <sub>IO</sub>		10 <sup>12</sup>	10 <sup>12</sup>	W
Capacitance (input-output) <sup>2</sup>	C <sub>IO</sub>	f = 1 MHz	2.0	2.0	pF
Input capacitance <sup>3</sup>	C <sub>I</sub>		4.0	4.0	pF

1. The values in this table correspond to the nominal creepage and clearance values. VDE certifies the clearance and creepage limits as 4.7 mm minimum for the SOIC-8 package and 8.5 mm minimum for the WB SOIC-16 package. UL does not impose a clearance and creepage minimum for component-level certifications. CSA certifies the clearance and creepage limits as 3.9 mm minimum for the SOIC-8 and 7.6 mm minimum for the WB SOIC-16 package.
2. To determine resistance and capacitance, the Si86xx is converted into a 2-terminal device. All pins on the side 1 are shorted together to form the first terminal, the same is done with side 2 to form the second terminal. The parameters are then measured between these two terminals.
3. Measured from input pin to ground.

Table 11. IEC 60664-1 Ratings

Parameter	Test Conditions	Specification	
		WB SOIC-16	SOIC-8
Basic isolation group	Material group	I	I
Installation classification	Rated mains voltages $\leq 150 V_{RMS}$	I-IV	I-IV
	Rated mains voltages $\leq 300 V_{RMS}$	I-IV	I-III
	Rated mains voltages $\leq 400 V_{RMS}$	I-III	I-II
	Rated mains voltages $\leq 600 V_{RMS}$	I-III	I-II

Table 12. VDE 0884-10 Insulation Characteristics<sup>1</sup>

Parameter	Symbol	Test Condition	Characteristic		Unit
			WB SOIC-16	SOIC-8	
Maximum working insulation voltage	$V_{IORM}$		1200	630	Vpeak
Input-to-output test voltage	$V_{PR}$	Method b1 ( $V_{IORM} \times 1.875 = V_{PR}$ , 100% Production Test, $t_m = 1 s$ , Partial Discharge < 5 pC)	2250	1182	Vpeak
Transient overvoltage	$V_{IOTM}$	$t = 60 sec$	6000	6000	Vpeak
Surge voltage	$V_{IOSM}$	Tested per IEC 60065 with surge voltage of 1.2 $\mu s/50 \mu s$ Si86xxxT tested with magnitude 6250 V x 1.6 = 10 kV Si86xxxB/C/D tested with 4000 V	6250 4000	— 4000	Vpeak
Pollution degree (DIN VDE 0110, Table 1)			2	2	
Insulation resistance at $T_S, V_{IO} = 500 V$	$R_S$		$>10^9$	$>10^9$	$\Omega$

1. Maintenance of the safety data is ensured by protective circuits. The Si86xxxx provides a climate classification of 40/125/21.

Table 13. IEC Safety Limiting Values<sup>1</sup>

Parameter	Symbol	Test Condition	Max		Unit
			WB SOIC-16	SOIC-8	
Safety temperature	$T_S$		150	150	$^{\circ}C$
Safety input current	$I_S$	$\theta_{JA} = 140 \text{ }^{\circ}C/W$ (SOIC-8) $100 \text{ }^{\circ}C/W$ (WB SOIC-16) $V_I = 5.5 V, T_J = 150 \text{ }^{\circ}C, T_A = 25 \text{ }^{\circ}C$	220	160	mA
Device power dissipation <sup>2</sup>	$P_D$		150	150	mW

1. Maximum value allowed in the event of a failure; also see the thermal derating curves in Figure 14 and Figure 15 on page 20.  
 2. The Si86xx is tested with VDD1 = VDD2 = 5.5 V;  $T_J = 150 \text{ }^{\circ}C$ ;  $C_L = 15 pF$ , input a 150 Mbps 50% duty cycle square wave.

Table 14. Thermal Characteristics

Parameter	Symbol	WB SOIC-16	SOIC-8	Unit
IC junction-to-air thermal resistance	$\theta_{JA}$	100	140	$^{\circ}\text{C}/\text{W}$

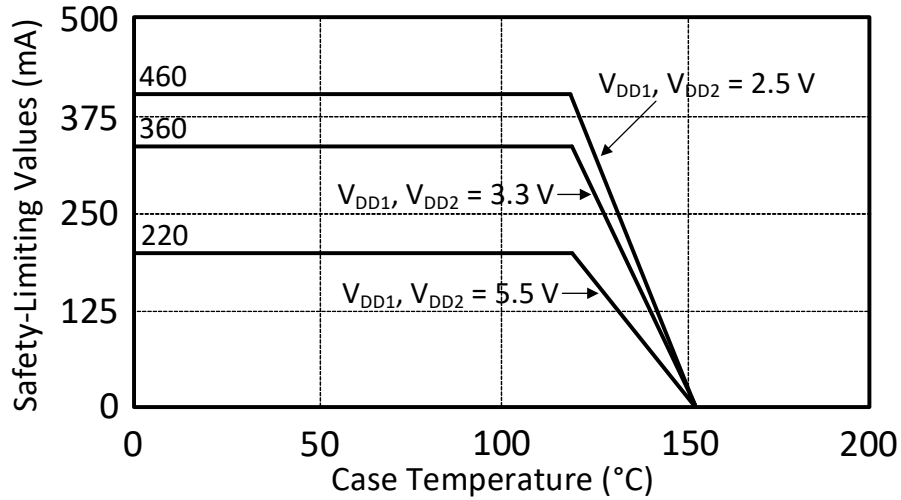

Figure 14. (WB SOIC-16) Thermal Derating Curve for Safety Limiting Current

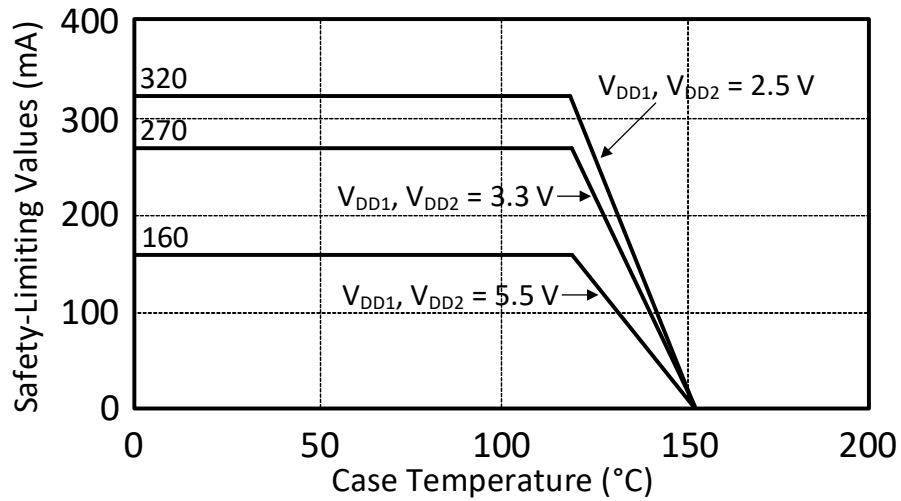

Figure 15. (SOIC-8) Thermal Derating Curve for Safety Limiting Current

### 7. Package Outline: WB SOIC-16

Figure 16 illustrates the package details for the Triple-Channel Digital Isolator. Table 16 lists the values for the dimensions shown in the illustration.

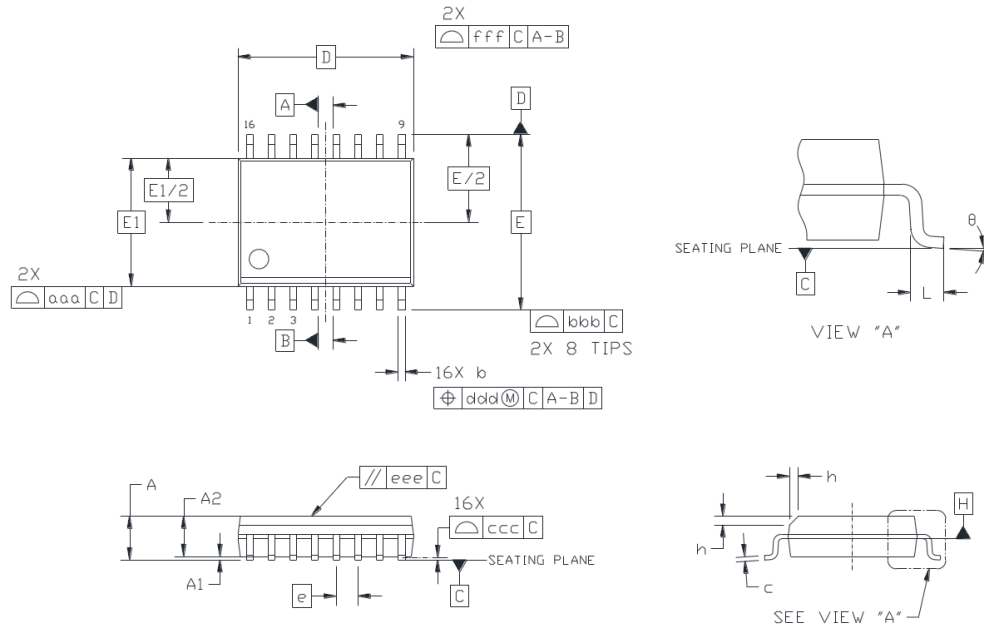

Figure 16. WB SOIC-16

Table 15. WB SOIC-16 Package Diagram Dimensions<sup>1,2,3,4</sup>

Dimension	Min	Max
A	—	2.65
A1	0.10	0.30
A2	2.05	—
b	0.31	0.51
c	0.20	0.33
D	10.30 BSC	
E	10.30 BSC	
E1	7.50 BSC	
e	1.27 BSC	
L	0.40	1.27
h	0.25	0.75
θ	0°	8°
aaa	—	0.10
bbb	—	0.33
ccc	—	0.10
ddd	—	0.25
eee	—	0.10
fff	—	0.20

1. All dimensions shown are in millimeters (mm) unless otherwise noted.
2. Dimensioning and Tolerancing per ANSI Y14.5M-1994.
3. This drawing conforms to JEDEC Outline MS-013, Variation AA.
4. Recommended reflow profile per JEDEC J-STD-020 specification for small body, lead-free components.

### 8. Land Pattern: WB SOIC-16

Figure 17 illustrates the recommended land pattern details for the Si861x/2x in a WB SOIC-16 package. Table 17 lists the values for the dimensions shown in the illustration.

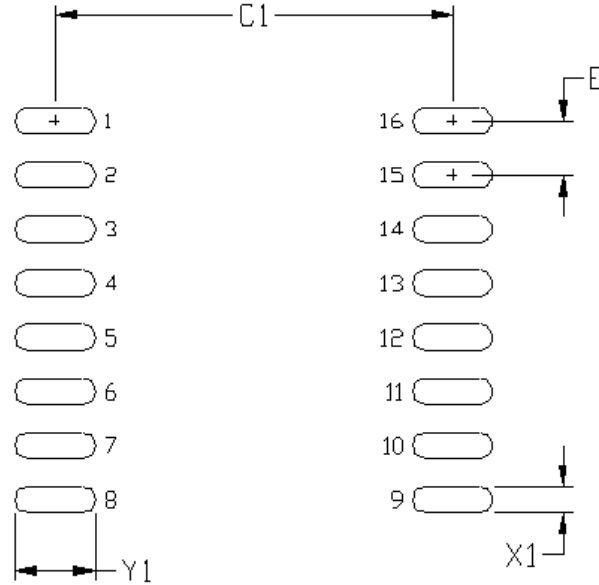

Figure 17. PCB Land Pattern: WB SOIC-16

Table 16. WB SOIC-16 Land Pattern Dimensions<sup>1,2</sup>

Dimension	Feature	(mm)
C1	Pad column spacing	9.40
E	Pad row pitch	1.27
X1	Pad width	0.60
Y1	Pad length	1.90

1. This Land Pattern Design is based on IPC-7351 pattern SOIC127P1032X265-16AN for Density Level B (Median Land Protrusion).  
 2. All feature sizes shown are at Maximum Material Condition (MMC) and a card fabrication tolerance of 0.05 mm is assumed.

### 9. Package Outline: SOIC-8

Figure 18 illustrates the package details for the Si86xx. The table lists the values for the dimensions shown in the illustration.

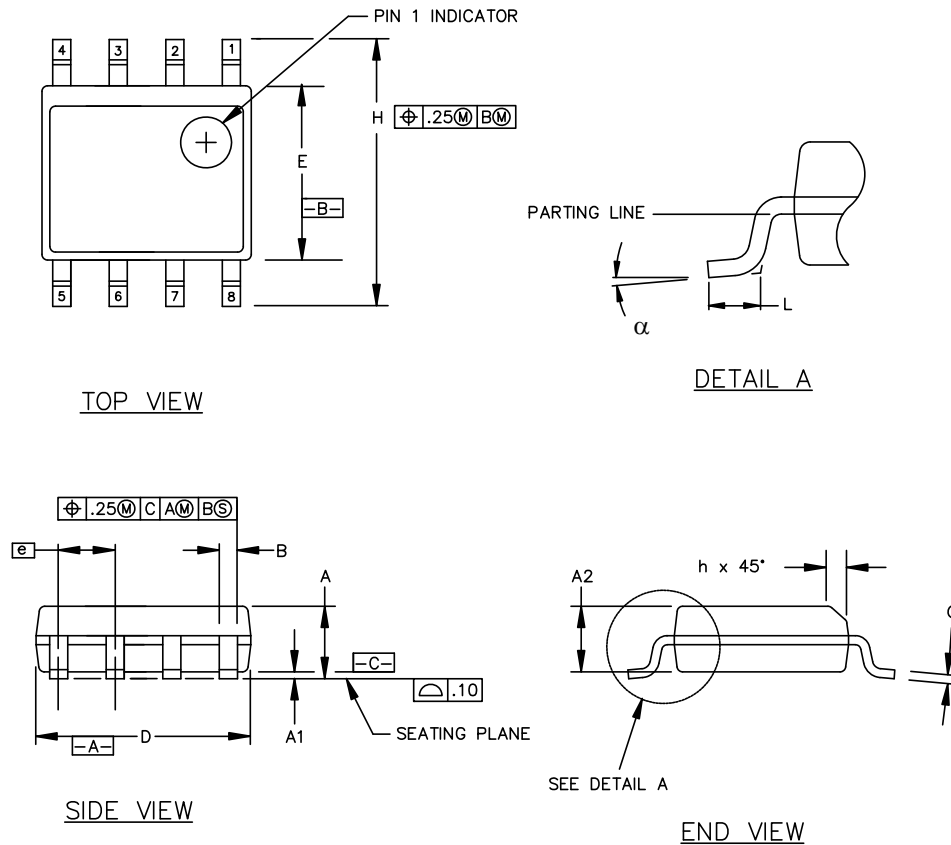

Figure 18. SOIC-8 Package

Table 17. SOIC-8 Package Diagram Dimensions

Symbol	Millimeters	
	Min	Max
A	1.35	1.75
A1	0.10	0.25
A2	1.40 REF	1.55 REF
B	0.33	0.51
C	0.19	0.25
D	4.80	5.00
E	3.80	4.00
e	1.27 BSC	
H	5.80	6.20
h	0.25	0.50
L	0.40	1.27
m	0°	8°

### 10. Land Pattern: SOIC-8

Figure 19 illustrates the recommended land pattern details for the Si86xx in a SOIC-8. Table 19 lists the values for the dimensions shown in the illustration.

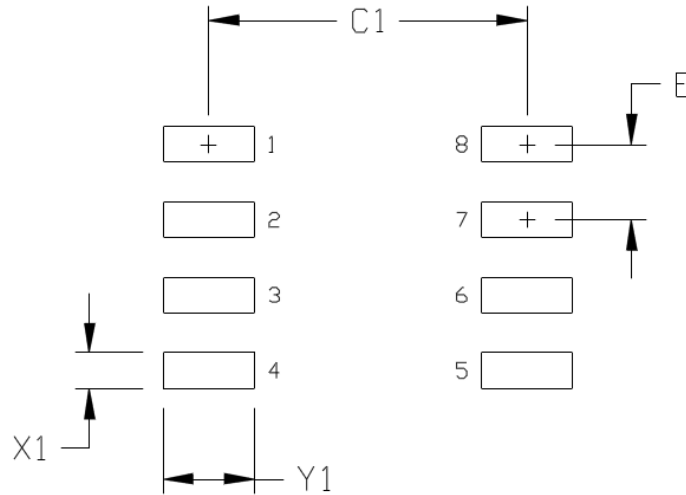

Figure 19. PCB Land Pattern: SOIC-8

Table 18. SOIC-8 Land Pattern Dimensions<sup>1,2</sup>

Dimension	Feature	(mm)
C1	Pad column spacing	5.40
E	Pad row pitch	1.27
X1	Pad width	0.60
Y1	Pad length	1.55

1. This Land Pattern Design is based on IPC-7351 pattern SOIC127P600X173-8N for Density Level B (Median Land Protrusion).  
 2. All feature sizes shown are at Maximum Material Condition (MMC) and a card fabrication tolerance of 0.05 mm is assumed.



11. Top Marking: WB SOIC-16

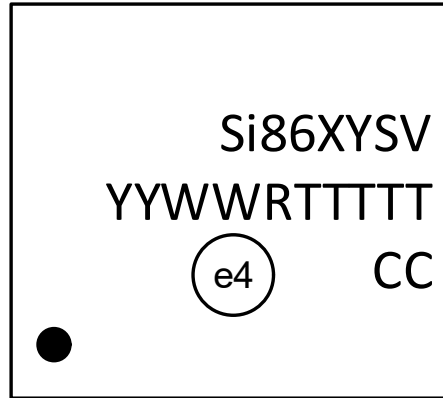

Figure 20. WB SOIC-16 Top Marking

Table 19. WB SOIC-16 Top Marking Explanation

<b>Line 1 Marking:</b>	Base Part Number Ordering Options  (See “1. Ordering Guide” on page 2 for more information.)	Si86 = Isolator product series X = # of data channels (2, 1) Y = # of reverse channels (2, 1, 0) <sup>1</sup>  S = Speed Grade (max data rate) and operating mode: B = 150 Mbps (default output = low) E = 150 Mbps (default output = high)  V = Insulation rating B = 2.5 kV; C = 3.75 kV; D = 5.0 kV; T = 5.0 = kV with 10 kV surge capability.
	<b>Line 2 Marking:</b>	YY = Year WW = Workweek  Assigned by assembly subcontractor. Corresponds to the year and workweek of the mold date.
<b>Line 3 Marking:</b>	RTTTTT = Mfg Code	Manufacturing code from assembly house. “R” indicates revision.
	Circle = 1.7 mm Diameter (Center-Justified)  Country of Origin ISO Code Abbreviation	“e4” Pb-Free Symbol.  CC = Country of Origin ISO Code Abbreviation. TW = Taiwan. TH = Thailand.

1. The Si8622 has one forward and one reverse channel, but directionality is reversed compared to the Si8621, as shown in “5. Pin Descriptions (WB SOIC-16)” on page 21 and “6. Pin Descriptions (SOIC-8)” on page 22.

12. Top Marking: SOIC-8

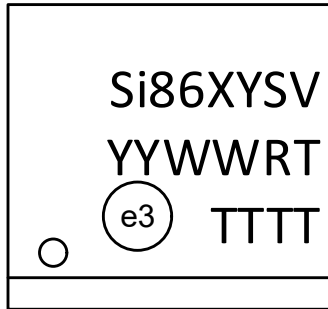

Figure 21. SOIC-8 Top Marking

Table 20. SOIC-8 Top Marking Explanation<sup>1</sup>

<b>Line 1 Marking:</b>	Base Part Number Ordering Options  (See “1. Ordering Guide” on page 2 for more information.)	Si86 = Isolator Product Series XY = Channel Configuration S = Speed Grade (max data rate) V = Insulation rating
	<b>Line 2 Marking:</b>	YY = Year WW = Workweek
<b>Line 3 Marking:</b>	R = Product (OPN) Revision T = First character of the manufacturing code	Assigned by assembly subcontractor. Corresponds to the year and workweek of the mold date.  First two characters of the manufacturing code from Assembly.
	Circle = 1.1 mm Diameter  TTTT = Last four characters of the manufacturing code	“e3” Pb-Free Symbol.  Last four characters of the manufacturing code.

1. The Si8622 has one forward and one reverse channel, but directionality is reversed compared to the Si8621, as shown in “5. Pin Descriptions (WB SOIC-16)” on page 21 and “6. Pin Descriptions (SOIC-8)” on page 22

### 13. Ordering Guide

#### 13.1. Industrial and Automotive Grade OPNs

Industrial-grade devices (part numbers having an “-I” in their suffix) are built using well-controlled, high-quality manufacturing flows to ensure robustness and reliability. Qualifications are compliant with JEDEC, and defect reduction methodologies are applied across the definition, design, evaluation, qualification, and mass production steps.

Automotive-grade devices (part numbers having an “-A” in their suffix) are built using automotive-specific flows at all steps in the manufacturing process to ensure robustness and low defectivity. These devices are supported with AIAG-compliant Production Part Approval Process (PPAP) documentation, and feature International Material Data System (IMDS) and China Automotive Material Data System (CAMDS) listing. Qualifications are compliant with AEC-Q100, and a zero-defect methodology is maintained throughout the definition, design, evaluation, qualification, and mass production steps.

See “11. Top Marking: WB SOIC-16” on page 33 and “12. Top Marking: SOIC-8” on page 35 for part number decoders.

Table 21. Ordering Guide for Valid OPNs <sup>1,2,3</sup>

Ordering Part Number (OPN) <sup>4</sup>	Automotive OPNs <sup>5,6</sup>	Number of Inputs VDD1 Side	Number of Inputs VDD2 Side	Max Data Rate (Mbps)	Default Output State	Isolation Rating (kV)	Package
Si8610BB-B-IS	Si8610BB-AS	1	0	150	Low	2.5	SOIC-8
Si8610BC-B-IS	Si8610BC-AS	1	0	150	Low	3.75	SOIC-8
Si8610EC-B-IS	Si8610EC-AS	1	0	150	High	3.75	SOIC-8
Si8610BD-B-IS	Si8610BD-AS	1	0	150	Low	5.0	WB SOIC-16
Si8610ED-B-IS	Si8610ED-AS	1	0	150	High	5.0	WB SOIC-16
Si8620BB-B-IS	Si8620BB-AS	2	0	150	Low	2.5	SOIC-8
Si8620EB-B-IS	Si8620EB-AS	2	0	150	High	2.5	SOIC-8
Si8620BC-B-IS	Si8620BC-AS	2	0	150	Low	3.75	SOIC-8
Si8620EC-B-IS	Si8620EC-AS	2	0	150	High	3.75	SOIC-8
Si8620BD-B-IS	Si8620BD-AS	2	0	150	Low	5.0	WB SOIC-16
Si8620ED-B-IS	Si8620ED-AS	2	0	150	High	5.0	WB SOIC-16
Si8621BB-B-IS	Si8621BB-AS	1	1	150	Low	2.5	SOIC-8
Si8621BC-B-IS	Si8621BC-AS	1	1	150	Low	3.75	SOIC-8
Si8621EC-B-IS	Si8621EC-AS	1	1	150	High	3.75	SOIC-8
Si8621BD-B-IS	Si8621BD-AS	1	1	150	Low	5.0	WB SOIC-16
Si8621ED-B-IS	Si8621ED-AS	1	1	150	High	5.0	WB SOIC-16
Si8622BB-B-IS	Si8622BB-AS	1	1	150	Low	2.5	SOIC-8
Si8622EB-B-IS	Si8622EB-AS	1	1	150	High	2.5	SOIC-8
Si8622BC-B-IS	Si8622BC-AS	1	1	150	Low	3.75	SOIC-8
Si8622EC-B-IS	Si8622EC-AS	1	1	150	High	3.75	SOIC-8
Si8622BD-B-IS	Si8622BD-AS	1	1	150	Low	5.0	WB SOIC-16
Si8622ED-B-IS	Si8622ED-AS	1	1	150	High	5.0	WB SOIC-16

Table 21. Ordering Guide for Valid OPNs <sup>1,2,3</sup> (Continued)

Ordering Part Number (OPN) <sup>4</sup>	Automotive OPNs <sup>5,6</sup>	Number of Inputs VDD1 Side	Number of Inputs VDD2 Side	Max Data Rate (Mbps)	Default Output State	Isolation Rating (kV)	Package
<b>Product Options with Reinforced VDE 0884-10 Rating with 10 kV Surge Capability</b>							
Si8620BT-IS	Si8620BT-AS	2	0	150	Low	5.0	WB SOIC-16
Si8620ET-IS	Si8620ET-AS	2	0	150	High	5.0	WB SOIC-16
Si8621BT-IS	Si8621BT-AS	1	1	150	Low	5.0	WB SOIC-16
Si8621ET-IS	Si8621ET-AS	1	1	150	High	5.0	WB SOIC-16
Si8622BT-IS	Si8622BT-AS	1	1	150	Low	5.0	WB SOIC-16
Si8622ET-IS	Si8622ET-AS	1	1	150	High	5.0	WB SOIC-16

1. All packages are RoHS-compliant with peak reflow temperatures of 260 °C according to the JEDEC industry standard classifications and peak solder temperatures
2. "Si" and "SI" are used interchangeably.
3. The temperature range is -40 to +125 °C.
4. An "R" at the end of the part number denotes tape and reel packaging option.
5. Automotive-Grade devices (with an "-A" suffix) are identical in construction materials, topside marking, and electrical parameters to their Industrial-Grade (with an "-I" suffix) version counterparts. Automotive-Grade products are produced utilizing full automotive process flows and additional statistical process controls throughout the manufacturing flow. The Automotive-Grade part number is included on shipping labels.
6. In the top markings of each device, the Manufacturing Code represented by either "RTTTTT" or "TTTTTT" contains as its first character a letter in the range N through Z to indicate Automotive-Grade.

### 14. Revision History

Revision	Date	Description
B	September, 2023	Removed "-IM1" part numbers and references to DFN-8 package.
A	July, 2022	Added Agile data sheet revision in footer.
1.76	December, 2020	Added DFN-8 package option. Corrected typos in VT+, VT- and V <sub>HYS</sub> values in Table 8, "Electrical Characteristics," on page 16. Standardized package designations across document.
1.75	September, 2019	Updated Ordering Guide.
1.74	October, 2018	Updated the Ordering Guide for Automotive-Grade OPN options.
1.73	May, 2018	Updated the Ordering Guide for Automotive-Grade OPN options.
1.72	April, 2018	Added Si8610ED-AS to Ordering Guide for Automotive-Grade OPN options.
1.71		Added new table to Ordering Guide for Automotive-Grade OPN options.
1.7		Added following note to Ordering Guide: "An "R" at the end of the part number denotes tape and reel packaging option."
1.6		Added product options Si862xxT in Ordering Guide. Added spec line items for Input Leakage Current pertaining to Si862xxT in Ordering Guide. Updated IEC 60747-5-2 to IEC 60747-5-5 in all instances in document.
1.5		Updated Table 5 on page 17. Added CQC certificate numbers. Updated "5. Ordering Guide" on page 11. Removed references to moisture sensitivity levels. Removed Note 2.
1.4		Added Figure 2, "Common Mode Transient Immunity Test Circuit," on page 8. Added references to CQC throughout. Added references to 2.5 kV <sub>RMS</sub> devices throughout. Updated "5. Ordering Guide" on page 11. Updated "10.1. WB SOIC-16 Top Marking" on page 18.
1.3		Updated Table 11 on page 21. Added junction temperature spec. Updated "2.3.1. Supply Bypass" on page 6. Removed "3.3.2. Pin Connections" on page 22. Updated "5. Ordering Guide" on page 11. Removed Rev A devices. Updated "6. Package Outline: WB SOIC-16" on page 13. Updated Top Marks. Added revision description.
1.2		Updated Table 1 on page 4. Deleted reference to EN. Updated "5. Ordering Guide" on page 11 to include MSL2A.
1.1		Updated High Level Output Voltage VOH to 3.1 V in Table 3, "Electrical Characteristics," on page 9. Updated High Level Output Voltage VOH to 2.3 V in Table 4, "Electrical Characteristics," on page 13.
1.0		Updated "Table 3. Electrical Characteristics". Reordered spec tables to conform to new convention. Removed "pending" throughout document.
0.3		Added chip graphics on page 1. Updated Table 6, "Insulation and Safety-Related Specifications," on page 18. Updated Table 8, "IEC 60747-5-5 Insulation Characteristics for Si86xxxx*," on page 19. Updated "3. Pin Descriptions (WB SOIC-16)" on page 9. Updated "4. Pin Descriptions (SOIC-8)" on page 10. Updated "5. Ordering Guide" on page 11.
0.2		Added chip graphics on page 1. Moved Tables 1 and 11 to page 21. Updated Table 6, "Insulation and Safety-Related Specifications," on page 18. Updated Table 8, "IEC 60747-5-5 Insulation Characteristics for Si86xxxx*," on page 19. Moved Table 1 to page 4. Moved "Typical Performance Characteristics" to page 7. Updated "3. Pin Descriptions (WB SOIC-16)" on page 9. Updated "4. Pin Descriptions (SOIC-8)" on page 10. Updated "5. Ordering Guide" on page 11.

Copyright © 2023, Skyworks Solutions, Inc. All Rights Reserved.

Information in this document is provided in connection with Skyworks Solutions, Inc. ("Skyworks") products or services. These materials, including the information contained herein, are provided by Skyworks as a service to its customers and may be used for informational purposes only by the customer. Skyworks assumes no responsibility for errors or omissions in these materials or the information contained herein. Skyworks may change its documentation, products, services, specifications or product descriptions at any time, without notice. Skyworks makes no commitment to update the materials or information and shall have no responsibility whatsoever for conflicts, incompatibilities, or other difficulties arising from any future changes.

No license, whether express, implied, by estoppel or otherwise, is granted to any intellectual property rights by this document. Skyworks assumes no liability for any materials, products or information provided hereunder, including the sale, distribution, reproduction or use of Skyworks products, information or materials, except as may be provided in Skyworks' Terms and Conditions of Sale.

THE MATERIALS, PRODUCTS AND INFORMATION ARE PROVIDED "AS IS" WITHOUT WARRANTY OF ANY KIND, WHETHER EXPRESS, IMPLIED, STATUTORY, OR OTHERWISE, INCLUDING FITNESS FOR A PARTICULAR PURPOSE OR USE, MERCHANTABILITY, PERFORMANCE, QUALITY OR NON-INFRINGEMENT OF ANY INTELLECTUAL PROPERTY RIGHT; ALL SUCH WARRANTIES ARE HEREBY EXPRESSLY DISCLAIMED. SKYWORKS DOES NOT WARRANT THE ACCURACY OR COMPLETENESS OF THE INFORMATION, TEXT, GRAPHICS OR OTHER ITEMS CONTAINED WITHIN THESE MATERIALS. SKYWORKS SHALL NOT BE LIABLE FOR ANY DAMAGES, INCLUDING BUT NOT LIMITED TO ANY SPECIAL, INDIRECT, INCIDENTAL, STATUTORY, OR CONSEQUENTIAL DAMAGES, INCLUDING WITHOUT LIMITATION, LOST REVENUES OR LOST PROFITS THAT MAY RESULT FROM THE USE OF THE MATERIALS OR INFORMATION, WHETHER OR NOT THE RECIPIENT OF MATERIALS HAS BEEN ADVISED OF THE POSSIBILITY OF SUCH DAMAGE.

Skyworks products are not intended for use in medical, lifesaving or life-sustaining applications, or other equipment in which the failure of the Skyworks products could lead to personal injury, death, physical or environmental damage. Skyworks customers using or selling Skyworks products for use in such applications do so at their own risk and agree to fully indemnify Skyworks for any damages resulting from such improper use or sale.

Customers are responsible for their products and applications using Skyworks products, which may deviate from published specifications as a result of design defects, errors, or operation of products outside of published parameters or design specifications. Customers should include design and operating safeguards to minimize these and other risks. Skyworks assumes no liability for applications assistance, customer product design, or damage to any equipment resulting from the use of Skyworks products outside of Skyworks' published specifications or parameters.

Skyworks, the Skyworks symbol, Sky5®, SkyOne®, SkyBlue™, Skyworks Green™, ClockBuilder®, DSPLL®, ISOmodem®, ProSLIC®, SiPHY®, and RFelC® are trademarks or registered trademarks of Skyworks Solutions, Inc. or its subsidiaries in the United States and other countries. Third-party brands and names are for identification purposes only and are the property of their respective owners. Additional information, including relevant terms and conditions, posted at [www.skyworksinc.com](http://www.skyworksinc.com), are incorporated by reference.

单击下面可查看定价，库存，交付和生命周期等信息

[>>Skyworks\(思佳讯\)](#)