

## Electro-Static Discharge TESD05EB Bidirectional TVS Diode

### SOD-523

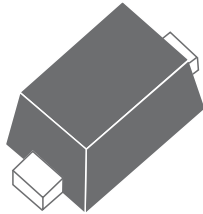

### Pin Configuration

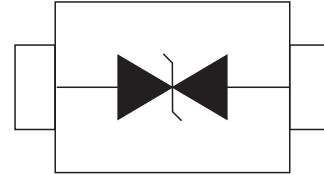

### Features

- 50 Watts Peak Pulse Power per Line ( $t_p=8/20\mu s$ )
- Protects one birectional I/O line
- Low clamping voltage
- Working voltages : 5V
- Low leakage current

### IEC Compatibility

- IEC61000-4-2 (ESD)  $\pm 15kV$  (air),  $\pm 8kV$  (contact)
- IEC61000-4-4 (EFT) 40A (5/50ns)

### Applications

- Cell Phone Handsets and Accessories
- Microprocessor based equipment
- Personal Digital Assistants(PDA's)
- Notebooks,Desktops,and Servers
- Portable Instrumentation
- Peripherals
- Pagers

### Mechanical Characteristics

- SOD-523 Package
- Molding Compound Flammability Rating:L 94V-O
- Quantity Per Reel:5000pcs
- Reel Size:7 inch
- Lead Finish:Lead Free

Maximum Ratings( $T_A=25^{\circ}\text{C}$  unless otherwise noted )

Maximum Ratings(@ $25^{\circ}\text{C}$ Unless Otherwise Specified)			
Parameter	Symbol	Value	Units
Peak Pulse Power( $t_p=8/20\mu\text{s}$ waveform)	$P_{PP}$	50	Watts
Lead Soldering Temperature	$T_L$	260(10 sec.)	$^{\circ}\text{C}$
Operating Temperature Range	$T_J$	-55~150	$^{\circ}\text{C}$
Storage Temperature Range	$T_{STG}$	-55~150	$^{\circ}\text{C}$

Electrical Characteristics( $T_A=25^{\circ}\text{C}$  unless otherwise specified)

TESD05EB(Marking: 0 )						
Parameter	Symbol	Conditions	Min.	Typ.	Max.	Units
Reverse Stand-off Voltage	$V_{RWM}$				5	V
Breakdown Voltage	$V_{BR}$	$I_T=1\text{mA}$	5.8			V
Clamping Voltage	$V_C$	$I_{PP}=5\text{A}, t_p=8/20\mu\text{s}$			10	V
Reverse Leakage Current	$I_R$	@ $V_{RWM}$			1	$\mu\text{A}$
Junction Capacitance	$C_{I/O}$	0Vdc, f=1MHz Between I/O Pins and GND		12		pF

Ratings and Characteristic Curves

Fig.1 Pulse Waveform

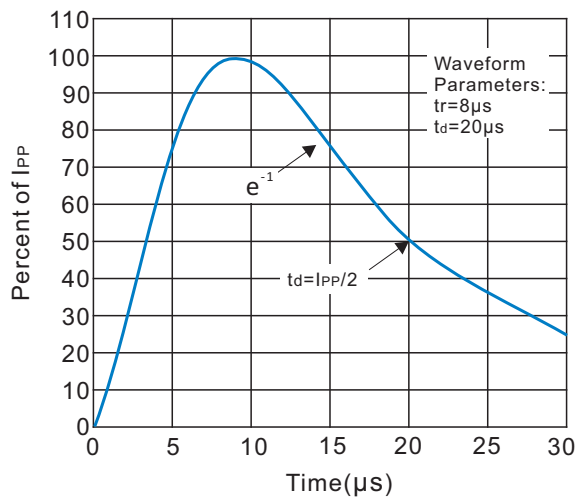
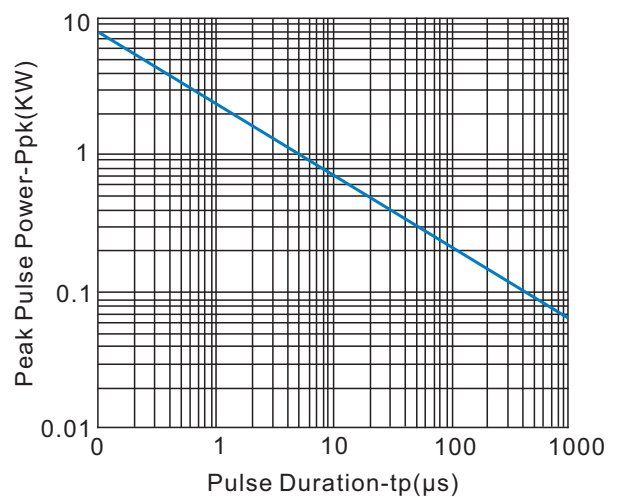
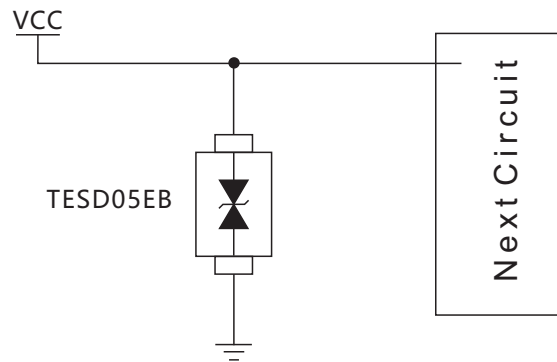

Fig.2 Non-Repetitive Peak Pulse Power vs. Pulse Time



## Application

### Power Protection



## Dimensions(SOD-523)

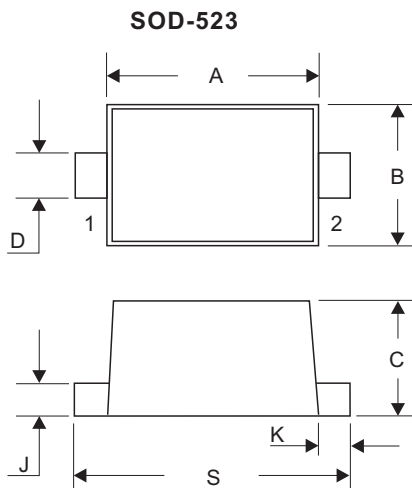

DIM	Millimeters		Inches	
	Min	Max	Min	Max
A	1.10	1.30	0.043	0.051
B	0.70	0.90	0.028	0.035
C	0.50	0.70	0.020	0.028
D	0.25	0.35	0.010	0.014
J	0.07	0.20	0.0028	0.0079
K	0.15	0.25	0.006	0.010
S	1.50	1.70	0.059	0.067

### Recommended Mounting Pad Layout

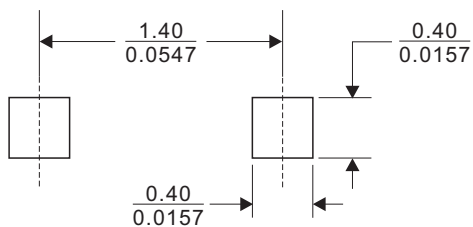

Dimensions in (  $\frac{\text{millimeters}}{\text{inches}}$  )

单击下面可查看定价，库存，交付和生命周期等信息

[>>SPSEMI](#)