

Electro-Static Discharge TESD03-36FB Bidirectional TVS Diode

SOD-323

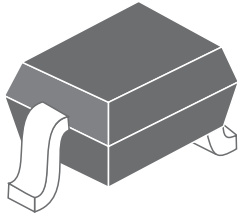

Pin Configuration

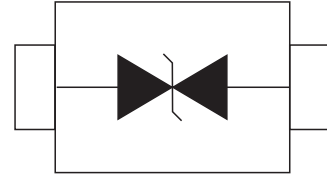

Features

- 320 Watts Peak Pulse Power per Line (tp=8/20μs)
- Protects one I/O or power line
- Low clamping voltage
- Working voltages: 3, 3V, 5V, 12V, 15V, 18V, 24V and 36V
- Low leakage current

IEC Compatibility

- IEC61000-4-2 (ESD) ±30kV (air), ±30kV (contact)
- IEC61000-4-4 (EFT) 40A (5/50ns)

Applications

- Cell Phone Handsets and Accessories
- Microprocessor based equipment
- Personal Digital Assistants(PDA's)
- Notebooks,Desktops,and Servers
- Portable Instrumentation
- Peripherals
- Pagers

Mechanical Characteristics

- JEDEC SOD-323 Package
- Molding Compound Flammability Rating:L 94V-O
- Weight 0.5 Milligrams(Approximate)
- Quantity Per Reel:3000pcs
- Reel Size:7 inch
- Lead Finish:Lead Free

Maximum Ratings($T_A=25^{\circ}\text{C}$ unless otherwise noted)

Parameter	Symbol	Value	Units
Peak Pulse Power($t_p=8/20\mu\text{s}$)	P_{PP}	320	Watts
Lead Soldering Temperature	T_L	260(10 sec.)	$^{\circ}\text{C}$
Operating Temperature Range	T_J	-55~150	$^{\circ}\text{C}$
Storage Temperature Range	T_{STG}	-55~150	$^{\circ}\text{C}$

Electrical Characteristics($T_A=25^{\circ}\text{C}$ unless otherwise specified)

TESD03FB(Marking:2A)

Parameter	Symbol	Conditions	Min.	Max.	Units
Reverse Stand-off Voltage	V_{RWM}			3.3	V
Breakdown Voltage	V_{BR}	$I_T=1\text{mA}$	3.6		V
Clamping Voltage	V_C	$I_{PP}=1\text{A}, t_p=8/20\mu\text{s}$		7.5	V
		$I_{PP}=18\text{A}, t_p=8/20\mu\text{s}$		13	V
Reverse Leakage Current	I_R	@ V_{RWM}		1	μA
Junction Capacitance	$C_{I/O}$	0Vdc, f=1MHz Between I/O Pins and GND		250	pF

TESD05FB(Marking:2B)

Parameter	Symbol	Conditions	Min.	Max.	Units
Reverse Stand-off Voltage	V_{RWM}			5	V
Breakdown Voltage	V_{BR}	$I_T=1\text{mA}$	6		V
Clamping Voltage	V_C	$I_{PP}=1\text{A}, t_p=8/20\mu\text{s}$		9.8	V
		$I_{PP}=17\text{A}, t_p=8/20\mu\text{s}$		18	V
Reverse Leakage Current	I_R	@ V_{RWM}		1	μA
Junction Capacitance	$C_{I/O}$	0Vdc, f=1MHz Between I/O Pins and GND		200	pF

TESD08FB(Marking:2C)

Parameter	Symbol	Conditions	Min.	Max.	Units
Reverse Stand-off Voltage	V_{RWM}			8	V
Breakdown Voltage	V_{BR}	$I_T=1\text{mA}$	8.5		V
Clamping Voltage	V_C	$I_{PP}=1\text{A}, t_p=8/20\mu\text{s}$		13.4	V
		$I_{PP}=15\text{A}, t_p=8/20\mu\text{s}$		25	V
Reverse Leakage Current	I_R	@ V_{RWM}		1	μA
Junction Capacitance	$C_{I/O}$	0Vdc, f=1MHz Between I/O Pins and GND		120	pF

Electrical Characteristics($T_A=25^{\circ}\text{C}$ unless otherwise specified)

TESD12FB(Marking:2D)					
Parameter	Symbol	Conditions	Min.	Max.	Units
Reverse Stand-off Voltage	V_{RWM}			12	V
Breakdown Voltage	V_{BR}	$I_T=1\text{mA}$	13.3		V
Clamping Voltage	V_C	$I_{PP}=1\text{A}, t_p=8/20\mu\text{s}$		19	V
		$I_{PP}=12\text{A}, t_p=8/20\mu\text{s}$		35	V
Reverse Leakage Current	I_R	@ V_{RWM}		1	μA
Junction Capacitance	$C_{I/O}$	0Vdc, f=1MHz Between I/O Pins and GND		100	pF

TESD15FB(Marking:2J)					
Parameter	Symbol	Conditions	Min.	Max.	Units
Reverse Stand-off Voltage	V_{RWM}			15	V
Breakdown Voltage	V_{BR}	$I_T=1\text{mA}$	16.7		V
Clamping Voltage	V_C	$I_{PP}=1\text{A}, t_p=8/20\mu\text{s}$		24	V
		$I_{PP}=10\text{A}, t_p=8/20\mu\text{s}$		40	V
Reverse Leakage Current	I_R	@ V_{RWM}		1	μA
Junction Capacitance	$C_{I/O}$	0Vdc, f=1MHz Between I/O Pins and GND		75	pF

TESD18FB(Marking:2K)					
Parameter	Symbol	Conditions	Min.	Max.	Units
Reverse Stand-off Voltage	V_{RWM}			18	V
Breakdown Voltage	V_{BR}	$I_T=1\text{mA}$	19		V
Clamping Voltage	V_C	$I_{PP}=1\text{A}, t_p=8/20\mu\text{s}$		29	V
		$I_{PP}=9\text{A}, t_p=8/20\mu\text{s}$		45	V
Reverse Leakage Current	I_R	@ V_{RWM}		1	μA
Junction Capacitance	$C_{I/O}$	0Vdc, f=1MHz Between I/O Pins and GND		57	pF

TESD24FB(Marking:2H)					
Parameter	Symbol	Conditions	Min.	Max.	Units
Reverse Stand-off Voltage	V_{RWM}			24	V
Breakdown Voltage	V_{BR}	$I_T=1\text{mA}$	26.7		V
Clamping Voltage	V_C	$I_{PP}=1\text{A}, t_p=8/20\mu\text{s}$		40	V
		$I_{PP}=7\text{A}, t_p=8/20\mu\text{s}$		52	V
Reverse Leakage Current	I_R	@ V_{RWM}		1	μA
Junction Capacitance	$C_{I/O}$	0Vdc, f=1MHz Between I/O Pins and GND		50	pF

Electrical Characteristics($T_A=25^{\circ}\text{C}$ unless otherwise specified)

TESD36FB(Marking:2N)					
Parameter	Symbol	Conditions	Min.	Max.	Units
Reverse Stand-off Voltage	V_{RWM}			36	V
Breakdown Voltage	V_{BR}	$I_T=1\text{mA}$	40		V
Clamping Voltage	V_C	$I_{PP}=1\text{A}, t_p=8/20\mu\text{s}$		60	V
		$I_{PP}=5\text{A}, t_p=8/20\mu\text{s}$		75	V
Reverse Leakage Current	I_R	@ V_{RWM}		1	μA
Junction Capacitance	$C_{I/O}$	0Vdc, f=1MHz Between I/O Pins and GND		40	pF

Ratings and Characteristic Curves

Fig.1 ESD Clamping Voltage Screenshot Positive 8 kV Contact per IEC61000-4-2

Fig.2 ESD Clamping Voltage Screenshot Negative 8 kV Contact per IEC61000-4-2

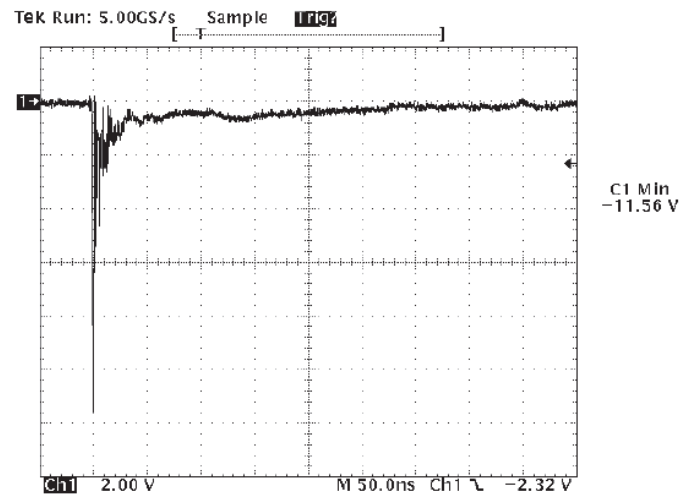
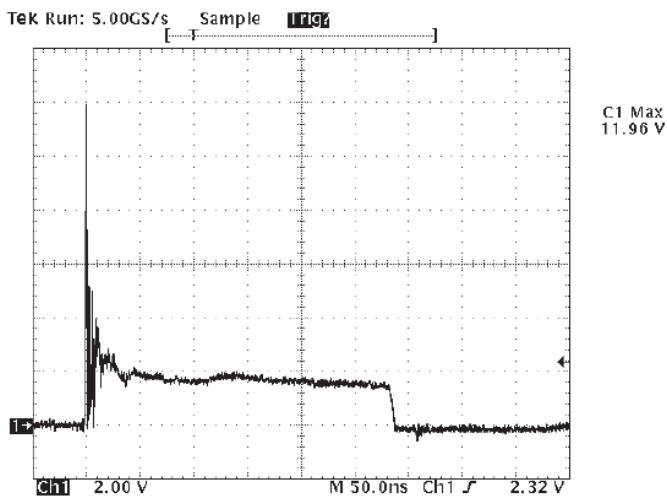

Application

Power Protection

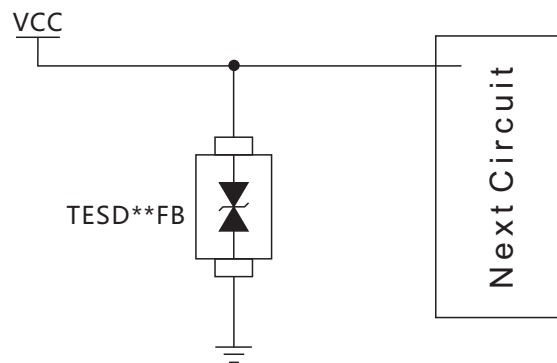

Dimensions(SOD-323)

SOD-323

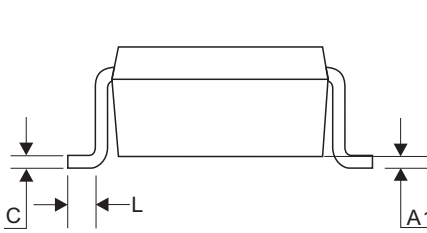
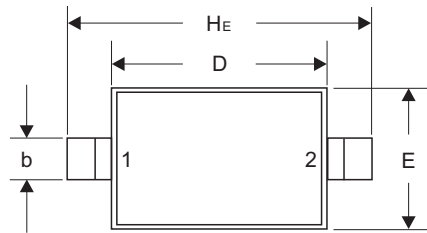

DIM	Millimeters		Inches	
	Min	Max	Min	Max
A	0.80	1.00	0.031	0.040
A1	0.00	0.10	0.000	0.004
A3	0.15REF		0.006REF	
b	0.25	0.40	0.010	0.016
C	0.089	0.177	0.003	0.007
D	1.60	1.80	0.062	0.070
E	1.15	1.35	0.045	0.053
L	0.08		0.003	
He	2.30	2.70	0.090	0.105

Recommended Mounting Pad Layout

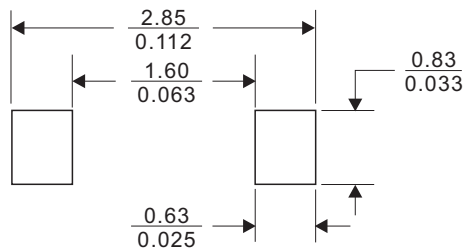

Dimensions in ($\frac{\text{millimeters}}{\text{inches}}$)

单击下面可查看定价，库存，交付和生命周期等信息

[>>SPSEMI](#)