

- Features:
- General purpose resistor ideal for commercial/industrial applications
 - Flame retardant coatings standard
 - Flameproof version available as CFF
 - Panasert available on selected sizes; contact factory
 - Auto sequencing/insertion compatible
 - CFM (mini) ideal choice when size constraints apply
 - Cut and formed product is available on select sizes; contact factory
 - Standard lead wire for CF/CFM is copper plated steel, with 100% tin over plate
 - 100% tin plate on copper wire is available as type CFQ/CFQM
 - RoHS compliant, lead-free and halogen-free



Electrical Specifications							
Type/Code	Power Rating (Watts) @ 70°C	Maximum Working Voltage ⁽¹⁾	Maximum Overload Voltage	Dielectric Withstanding Voltage	Resistance Temperature Coefficient per Ohmic Range	Ohmic Range (Ω) and Tolerance	
						2%	5%
CF18	0.125W	250V	500V	350V	<10Ω = ±400ppm/°C 10Ω to 9.99KΩ = 0 ~ -400ppm/°C 10KΩ to 99KΩ = 0 ~ -500ppm/°C 100KΩ to 999KΩ = 0 ~ -850ppm/°C 1MΩ and above = 0 ~ -1500ppm/°C	10 - 1M	1 - 22M
CF14	0.25W	350V	600V	350V		1 - 1M	
CF12	0.5W	350V	700V	600V		10 - 1M	
CF1	1W	500V	1,000V	600V		1 - 1M	1 - 10M
CF2	2W	500V	1,000V	600V			
CFM14	0.25W	250V	500V	350V			
CFM12	0.5W	350V	600V	350V			
CFM1	1W	600V	1,000V	600V			

(1) Lesser of $\sqrt{P \cdot R}$ or maximum working voltage.

Mechanical Specifications

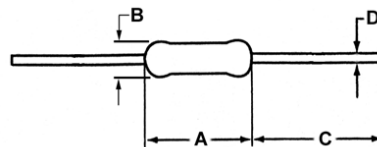

Type/Code	A Body Length	B Body Diameter	C Lead Length(Bulk)	D - Lead Diameter CF/CFM	D - Lead Diameter CFQ/CFQM	Unit
CF/CFQ18	0.130 ± 0.012 3.30 ± 0.30	0.067 ± 0.012 1.70 ± 0.30	1.102 ± 0.118 28.00 ± 3.00	0.016 ± 0.003 0.40 ± 0.08	0.018 ± 0.003 0.45 ± 0.08	inches mm
CF/CFQ14	0.236 ± 0.012 6.00 ± 0.30	0.091 ± 0.012 2.30 ± 0.30	1.102 ± 0.118 28.00 ± 3.00	0.022 ± 0.003 0.55 ± 0.08	0.022 ± 0.003 0.55 ± 0.08	inches mm
CF/CFQ12	0.335 ± 0.039 8.50 ± 1.00	0.106 ± 0.020 2.70 ± 0.50	1.102 ± 0.118 28.00 ± 3.00	0.022 ± 0.003 0.55 ± 0.08	0.028 ± 0.004 0.70 ± 0.10	inches mm
CF/CFQ1	0.433 ± 0.039 11.00 ± 1.00	0.177 ± 0.020 4.50 ± 0.50	1.181 ± 0.118 30.00 ± 3.00	0.031 ± 0.004 0.80 ± 0.10	0.031 ± 0.004 0.80 ± 0.10	inches mm
CF/CFQ2	0.591 ± 0.039 15.00 ± 1.00	0.197 ± 0.020 5.00 ± 0.50	1.339 ± 0.157 34.00 ± 4.00	0.031 ± 0.004 0.80 ± 0.10	0.031 ± 0.004 0.80 ± 0.10	inches mm
CFM/CFQM14	0.130 ± 0.012 3.30 ± 0.30	0.067 ± 0.012 1.70 ± 0.30	1.102 ± 0.118 28.00 ± 3.00	0.016 ± 0.003 0.40 ± 0.08	0.018 ± 0.003 0.45 ± 0.08	inches mm
CFM/CFQM12	0.236 ± 0.012 6.00 ± 0.30	0.091 ± 0.012 2.30 ± 0.30	1.102 ± 0.118 28.00 ± 3.00	0.022 ± 0.003 0.55 ± 0.08	0.022 ± 0.003 0.55 ± 0.08	inches mm
CFM/CFQM1	0.354 ± 0.020 9.00 ± 0.50	0.138 ± 0.020 3.50 ± 0.50	1.102 ± 0.118 28.00 ± 3.00	0.028 ± 0.002 0.70 ± 0.05	0.028 ± 0.002 0.70 ± 0.05	inches mm

Performance Characteristics							
Test	Test Method	Typical Result			Test Limit		
Current Noise	MIL-STD 202, Method 308	1Ω ~ 91KΩ	100KΩ ~ 910KΩ	1MΩ ~ 22MΩ	1Ω ~ 91KΩ	100KΩ ~ 910KΩ	1MΩ ~ 22MΩ
		0.15μV/V	0.32μV/V	0.54μV/V	0.2μV/V	0.4μV/V	0.6μV/V
Short Time Overload	JIS C5201-1, IEC60115-1, 4.13	<± 0.25%			≤± (0.75% + 0.05Ω)		
Resistance to Solder Heat	JIS C5201-1, IEC60115-1, 4.18	<± 0.3%			≤± (0.50% + 0.05Ω)		
Rapid Change of Temperature	JIS C5201-1, IEC60115-1, 4.19	<± 0.3%			≤± (1.00% + 0.05Ω)		
Endurance at 70°C	JIS C5201-1, IEC60115-1, 4.25.1	<± 1.0%			R<100KΩ: ≤± (2.0% + 0.05Ω) R≥100KΩ: ≤± (3.0% + 0.05Ω)		
Terminal Strength	MIL-STD 202, Method 211	<± 0.20%			≤± (0.50% + 0.05Ω)		
Damp Heat (Steady state)	JIS C5201-1, IEC60115-1, 4.24	<± 1.5%			R<100KΩ: ≤± (3.0% + 0.05Ω) R≥100KΩ: ≤± (5.0% + 0.05Ω)		

Operating Temperature Range: -55°C to +155°C

Power Derating Curve:

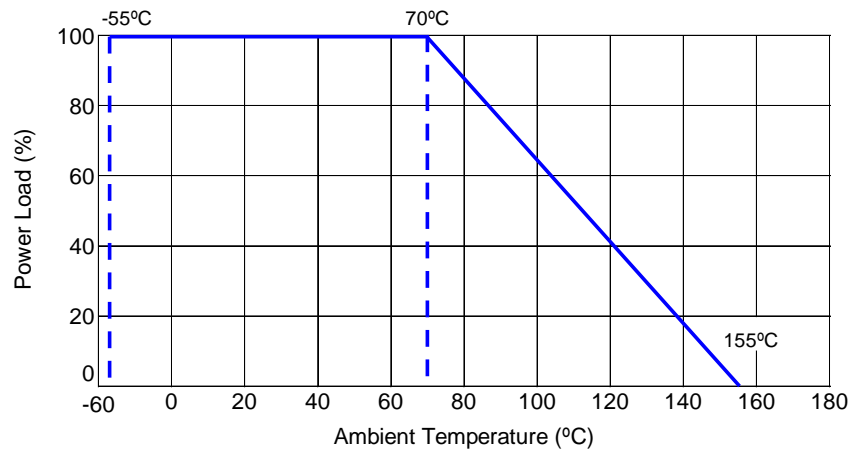

Single Pulse Power:

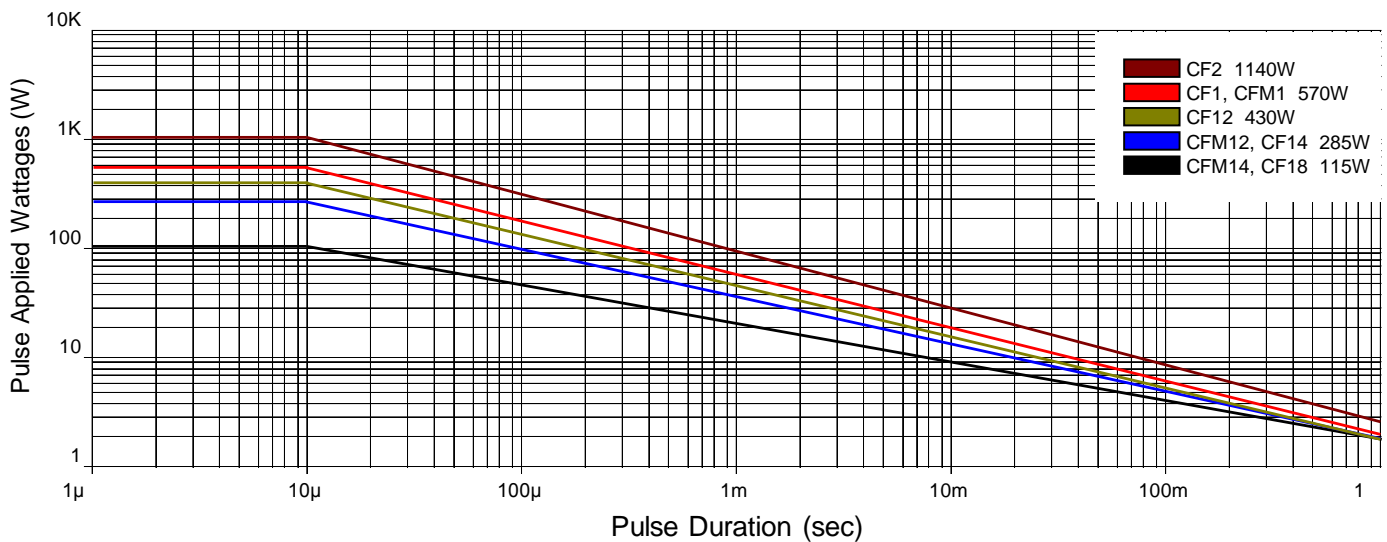

Typical performance for reference only.

Repetitive Pulse Data:

If repetitive pulses are applied to resistors, pulse wave form must be less than “Pulse limiting voltage”, “Pulse limiting current” or “Pulse limiting wattage” calculated by the formula below.

$$V_p = K\sqrt{P \times R \times T/t}$$

$$I_p = K\sqrt{P/R \times T/t}$$

$$P_p = K^2 \times P \times T/t$$

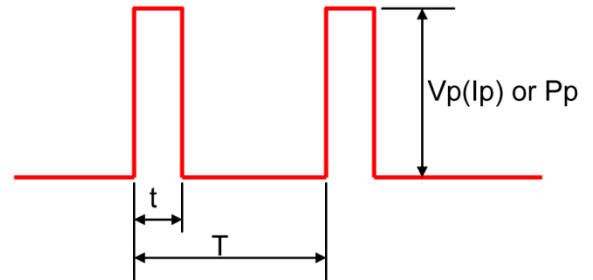

- Where:
- Vp: Pulse limiting voltage (V)
 - Ip: Pulse limiting current (A)
 - Pp: Pulse limiting wattage (W)
 - P: Power rating (W)
 - R: Nominal resistance (ohm)
 - T: Repetitive period (sec)
 - t: Pulse duration (sec)
 - K: Coefficient by resistors type (refer to below matrix)
 - [Vr: Rated Voltage (V), Ir: Rated Current (A)]

- Note 1: If $T > 10 \rightarrow T = 10$ (sec), $T/t > 1000 \rightarrow T/t = 1000$
- Note 2: If $T > 10$ and $T/t > 1000$, “Pulse Limiting power (Single pulse) is applied
- Note 3: If $V_p < V_r$ ($I_p < I_r$ or $P_p < P$), V_r (I_r , P) is V_p (I_p , P_p)
- Note 4: Pulse limiting voltage (Current, Wattage) is applied at less than rated ambient temperature. If ambient temperature is more than the rated temperature (70°C), please decrease power rating according to “Power Derating Curve”
- Note 5: Please assure sufficient margin for use period and conditions for “Pulse limiting voltage”
- Note 6: If the pulse waveform is not square wave, please judge after transform the waveform into square wave according to the “Waveform Transformation to Square Wave”.

Coefficient (K) Matrix	
Resistor Type	K
RNF, RNMF	0.7
CF, CFM, HDM	0.8
ASR, SPR, ASRM, SPRM	1.0
RSPF, RSPL	0.9
RSF, RSMF	0.8
FRN	0.6

Waveform Transformation to Square Wave

1. Discharge curve wave with time constant "t" → Square wave

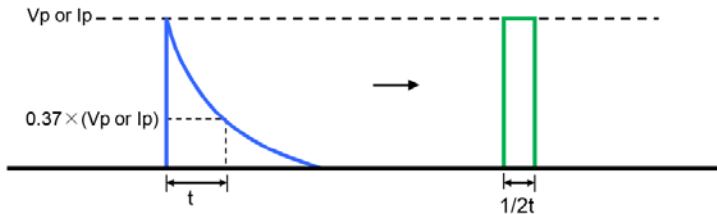

2. Damping oscillation wave with time constant of envelope "t" → Square wave

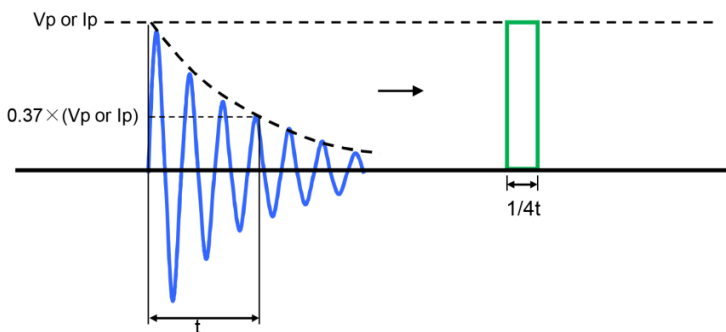

3. Half-wave rectification wave → Square wave

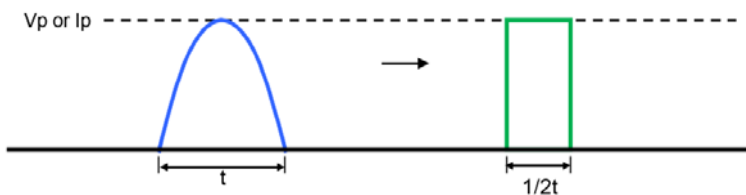

4. Triangular wave → Square wave

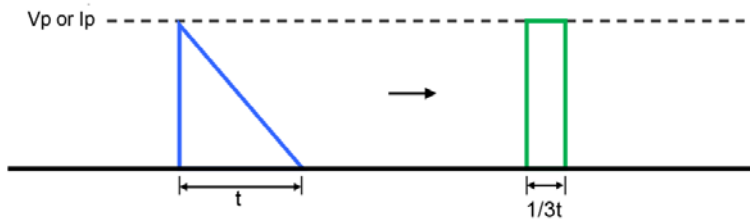

5. Special wave → Square wave

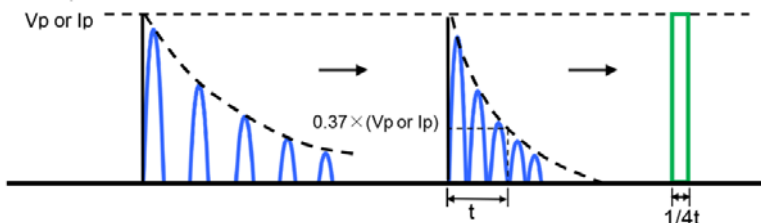

Current Noise:

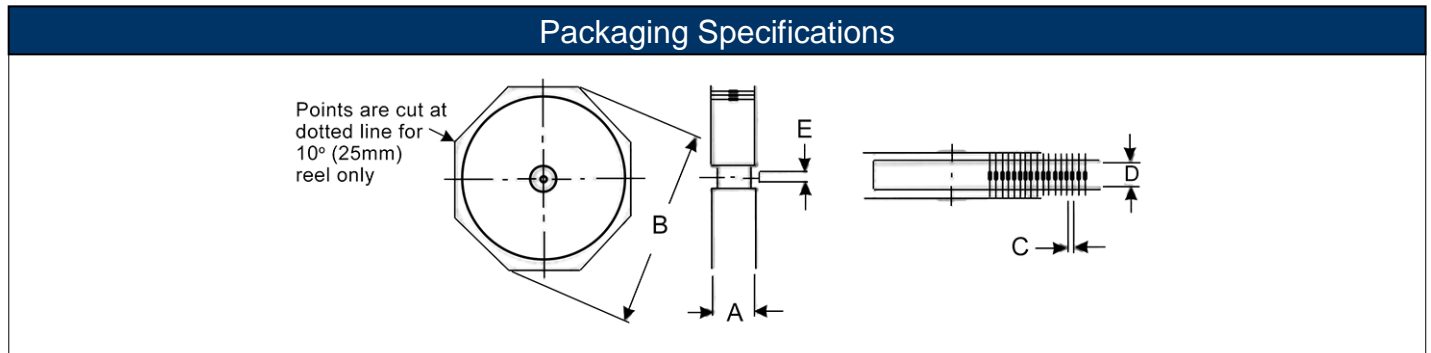
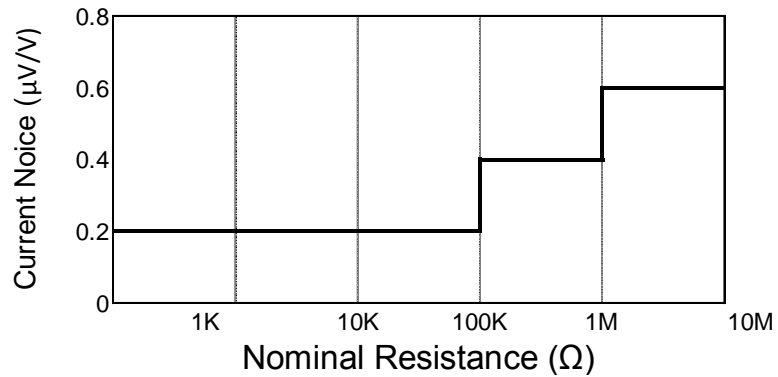

Type/Code	Class	Tape	A Max ⁽¹⁾	B Max	C	D ⁽²⁾	Unit
CF18, CFM14	I	0.250	2.508	13.504	0.197 ± 0.020	2.063 ± 0.079	inches
		6.35	63.70	343.00	5.00 ± 0.50	52.40 ± 2.00	mm
CF14, CFM12	I	0.250	2.638	13.504	0.197 ± 0.020	2.063 ± 0.079	inches
		6.35	67.00	343.00	5.00 ± 0.50	52.40 ± 2.00	mm
CF12, CFM1	I	0.250	2.736	13.504	0.197 ± 0.020	2.063 ± 0.079	inches
		6.35	69.50	343.00	5.00 ± 0.50	52.40 ± 2.00	mm
CF1	I	0.250	2.972	13.504	0.197 ± 0.020	2.063 ± 0.079	inches
		6.35	75.50	343.00	5.00 ± 0.50	52.40 ± 2.00	mm
CF2	I	0.250	3.130	13.504	0.394 ± 0.020	2.063 ± 0.079	inches
		6.35	79.50	343.00	10.00 ± 0.50	52.40 ± 2.00	mm

Dimension "E": This is a non-critical dimension that does not have a tolerance in the standard.

Range of diameters is from 0.547 inches (13.90 mm) to 1.500 inches (38.10 mm).

- (1) Reference value only. The "A" dimension shall be governed by the overall length of the taped component. The distance between flanges shall be 0.059 inches (1.50 mm) to 0.315 (8.00 mm) greater than the overall component.
- (2) The given dimension "D" expresses the standard width spacing. A 26mm narrow spacing is available as option "N" packaging code. Contact factory for more details.

Radial Lead Taping Specifications (Pana-Sert PCF14)

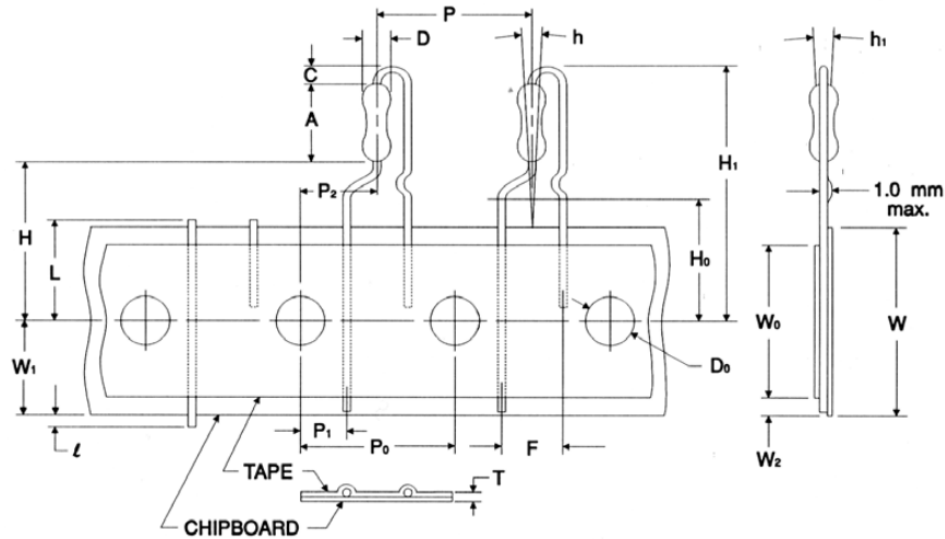

Symbol	Description	PANA-SERT	Unit
A	Resistor body length	0.256 ± 0.020 6.50 ± 0.50	inches mm
C	Height of bending	0.098 ± 0.020 2.50 ± 0.50	inches mm
D	Resistor body diameter	0.091 ± 0.008 2.30 ± 0.20	inches mm
D ₀	Sprocket-hole diameter	0.157 ± 0.012 4.00 ± 0.30	inches mm
F	Resistor lead spacing	0.197 ± 0.039 5.00 ± 1.00	inches mm
H	Height to bottom of resistor	0.748 ± 0.039 19.00 ± 1.00	inches mm
H ₀	Height to lead clinch	0.630 ± 0.020 16.00 ± 0.50	inches mm
H ₁	Height of resistor	1.122 max. 28.50 max.	inches mm
h	Resistor alignment	0 ± 0.079 (0±5°) 0 ± 2.00 (0±5°)	inches mm
h ₁	Resistor alignment	0 ± 0.079 (0±5°) 0 ± 2.00 (0±5°)	inches mm
l	Lead protrusion	0.079 max. 2.00 max.	inches mm

Symbol	Description	PANA-SERT	Unit
L	Cutout Length(1)	0.433 max. 11.00 max.	inches mm
P	Resistor pitch(1)	0.500 ± 0.039 12.70 ± 1.00	inches mm
P ₀	Sprocket-hole pitch(1)	0.500 ± 0.012 12.70 ± 0.30	inches mm
P ₁	Sprocket-hole center to lead center	0.152 ± 0.028 3.85 ± 0.70	inches mm
P ₂	Sprocket-hole center to resistor center(1)	0.250 ± 0.051 6.35 ± 1.30	inches mm
T	Thickness (chipboard and tape)	0.028 ± 0.008 0.70 ± 0.20	inches mm
W	Chipboard width(1)	0.709 + 0.039 / -0.020 18.00 + 1.00 / -0.50	inches mm
W ₀	Hold-down tape width	0.49 min. 12.50 min.	inches mm
W ₁	Sprocket-hole position	0.354 + 0.030 / -0.020 9.00 + 0.75 / -0.50	inches mm
W ₂	Hold-down tape position	0.118 max. 3.00 max.	inches mm

Surface Temperature Rise

Measurement Point

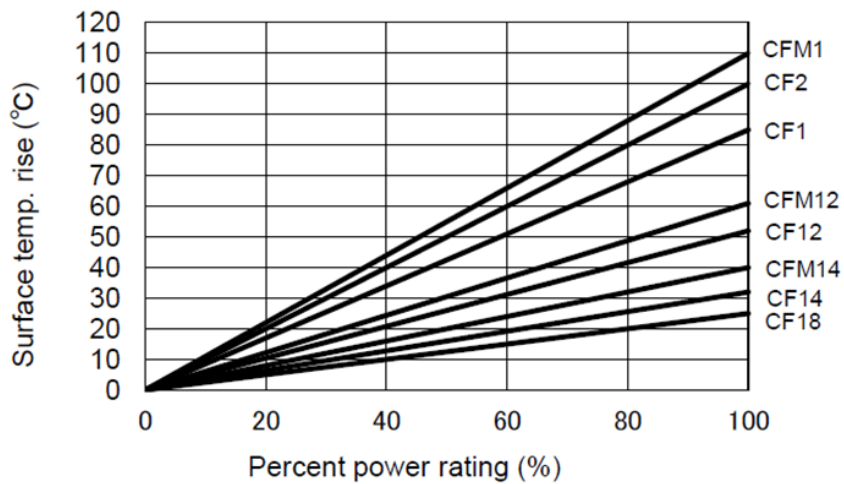
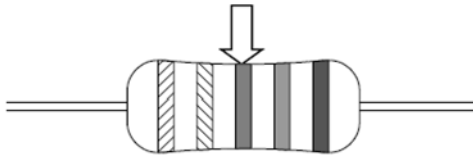

Standard Color Codes



PRECISION - Have three significant-figure bands, a multiplier band and a tolerance band. Tolerances 1% or less.

GENERAL PURPOSE - Have two significant-figure bands, a multiplier band and a tolerance band. Tolerances 2% or greater.

COLOR BAND DESCRIPTION		
BAND	PRECISION	GENERAL PURPOSE
1ST BAND	NOMINAL	NOMINAL
2ND BAND	NOMINAL	NOMINAL
3RD BAND	NOMINAL	MULTIPLIER
4TH BAND	MULTIPLIER	TOLERANCE
5TH BAND	TOLERANCE	-

	Nominal	Multiplier	Tolerance (%)
Black	0	1	-
Brown	1	10	1
Red	2	100	2
Orange	3	1K	-
Yellow	4	10K	-
Green	5	100K	0.5
Blue	6	1000K	0.25
Violet	7	-	0.1
Gray	8	-	-
White	9	0.001	-
Silver	-	0.01	10
Gold	-	0.1	5

RoHS Compliance

Stackpole Electronics has joined the worldwide effort to reduce the amount of lead in electronic components and to meet the various regulatory requirements now prevalent, such as the European Union's directive regarding "Restrictions on Hazardous Substances" (RoHS 3). As part of this ongoing program, we periodically update this document with the status regarding the availability of our compliant components. All our standard part numbers are compliant to EU Directive 2011/65/EU of the European Parliament as amended by Directive (EU) 2015/863/EU as regards the list of restricted substances.

RoHS Compliance Status						
Standard Product Series	Description	Package / Termination Type	Standard Series RoHS Compliant	Lead-Free Termination Composition	Lead-Free Mfg. Effective Date (Std Product Series)	Lead-Free Effective Date Code (YY/WW)
CF	Carbon Film Leaded Resistor	Axial	YES	100% Matte Sn	Jan-04 (Taiwan, China)	04/01
CFM	Mini-Carbon Film Leaded Resistor	Axial	YES	100% Matte Sn	Jan-04 (Taiwan, China)	04/01

"Conflict Metals" Commitment

We at Stackpole Electronics, Inc. are joined with our industry in opposing the use of metals mined in the "conflict region" of the eastern Democratic Republic of the Congo (DRC) in our products. Recognizing that the supply chain for metals used in the electronics industry is very complex, we work closely with our own suppliers to verify to the extent possible that the materials and products we supply do not contain metals sourced from this conflict region. As such, we are in compliance with the requirements of Dodd-Frank Act regarding Conflict Minerals.

Compliance to "REACH"

We certify that all passive components supplied by Stackpole Electronics, Inc. are SVHC (Substances of Very High Concern) free and compliant with the requirements of EU Directive 1907/2006/EC, "The Registration, Evaluation, Authorization and Restriction of Chemicals", otherwise referred to as REACH. Contact us for complete list of REACH Substance Candidate List.

Environmental Policy

It is the policy of Stackpole Electronics, Inc. (SEI) to protect the environment in all localities in which we operate. We continually strive to improve our effect on the environment. We observe all applicable laws and regulations regarding the protection of our environment and all requests related to the environment to which we have agreed. We are committed to the prevention of all forms of pollution.

How to Order

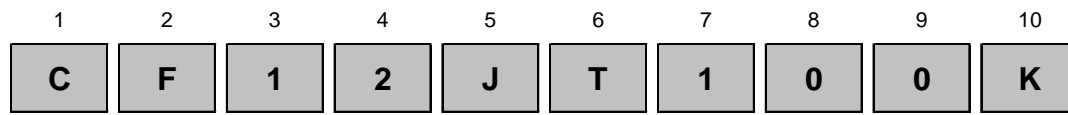

Product Series		Power Rating		Tolerance		Packaging			Resistance Value	
Code	Description	Code	Power	Code	Tol	Code	Description	Quantity		
CF	Standard	18	0.125W	G	2%	T	Tape and Reel	CF18, CFQ18, CFM14, CFQM14, CF14, CFQ14, CFM12, CFQM12, CF12, CFQ12, PCF14, PCFM12	5,000	Four characters with the multiplier used as the decimal holder. 10 ohm = 10R0 10.2 Kohm = 10K2 1 Mohm = 1M00
CFF	Flameproof	14	0.25W	J	5%			CFM1/CFQM1	2,500	
CFM	Mini	12	0.5W					CF1/CFQ1	2,000	
PCF	Panasert CF14	1	1W					CF2/CFQ2	1,000	
PCFM	Panasert CF12	2	2W			A	Ammo	CF18, CFQ18, CFM14, CFQM14, CF14, CFQ14, CFM12, CFQM12	5,000	
CFQ	Tin plating on copper wire							CF12, CFQ12, CFM1, CFQM1, PCF14, PCFM12, CF1, CFQ1	2,000	
CFQM	Tin plating (mini)							CF2	1,000	
PCFQ	Tin plating on copper wire Panasert					B	Bulk	All Sizes	1,000	

单击下面可查看定价，库存，交付和生命周期等信息

[>>Stackpole](#)