

Low noise and low drop voltage regulator with shutdown function

Datasheet - production data

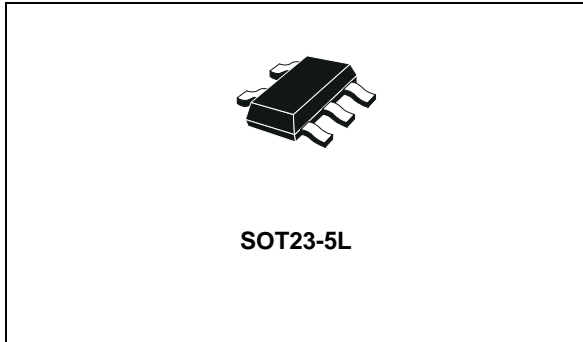

- Internal current and thermal limit
- Operative input voltage from:
 - $V_{OUT} + 0.5$ to 14 V (for $V_{OUT} > 2$ V) or from 2.5 V to 14 V (for $V_{OUT} < 2$ V)

Description

The LK112 is a low-dropout linear regulator with a built-in electronic switch. The internal switch can be controlled by TTL or CMOS logic levels. The device is on-state when the control pin is pulled to a logic high level. An external capacitor can be connected to the noise bypass pin to reduce the output noise level to 30 μ Vrms. An internal PNP pass transistor is used to achieve a low-dropout voltage. The LK112 has a very low quiescent current in on mode while in off mode I_q is reduced below 100 nA max. The internal thermal shutdown circuitry limits the junction temperature below 150 °C. Load current is internally monitored and the device shuts down in the presence of a short-circuit or overcurrent condition on the output.

Features

- Output current up to 150 mA
- Low-dropout voltage (350 mV at $I_{OUT} = 150$ mA)
- Very low quiescent current:
 - 0.1 μ A in OFF mode and max. 250 μ A in ON mode at $I_{OUT} = 0$ mA
- Low output noise:
 - typ. 30 μ V at $I_{OUT} = 60$ mA and $10 \text{ Hz} < f < 80 \text{ kHz}$
- Wide range of output voltages

Table 1. Device summary

Order codes	Output voltages
LK112M15TR	1.5V
LK112M18TR	1.8V
LK112M25TR	2.5V
LK112M33TR	3.3V
LK112M50TR	5.0V
LK112M55TR	5.5V
LK112M60TR	6.0V
LK112M80TR	8.0V

Contents

1	Diagram	3
2	Pin configuration	4
3	Maximum ratings	5
4	Electrical characteristics	6
5	Typical characteristics	7
6	Package mechanical data	13
7	Packaging mechanical data	15
8	Revision history	17

1 Diagram

Figure 1. Schematic diagram

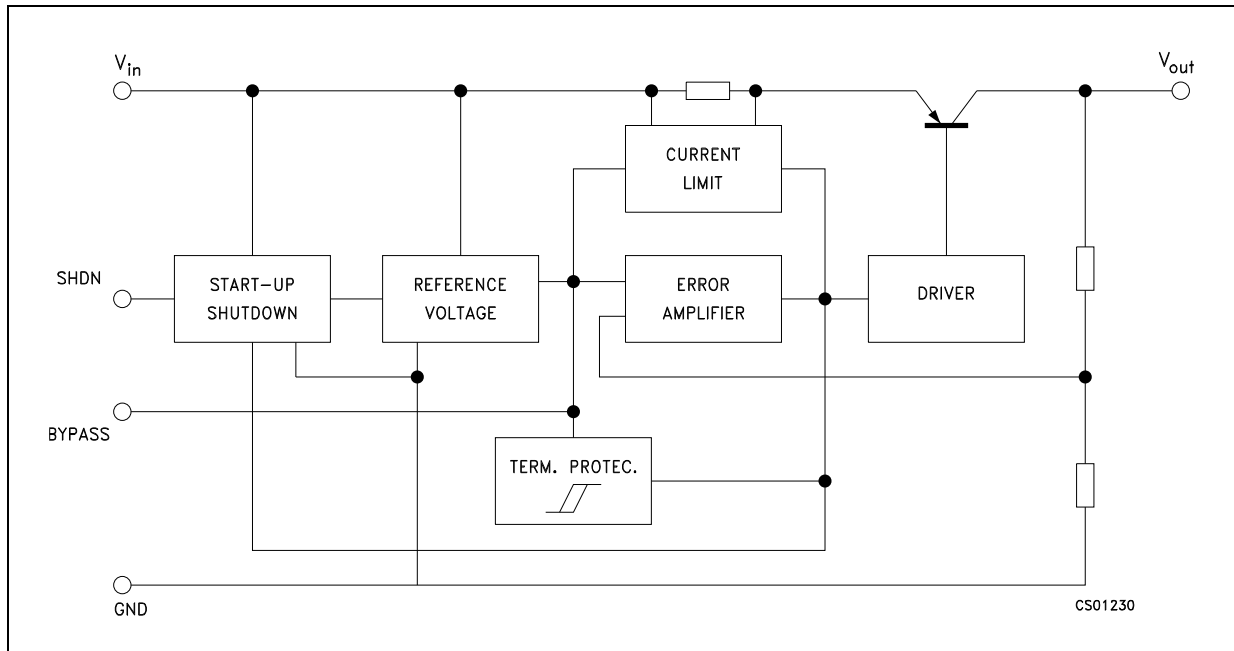

2 Pin configuration

Figure 2. Pin connection (top view)

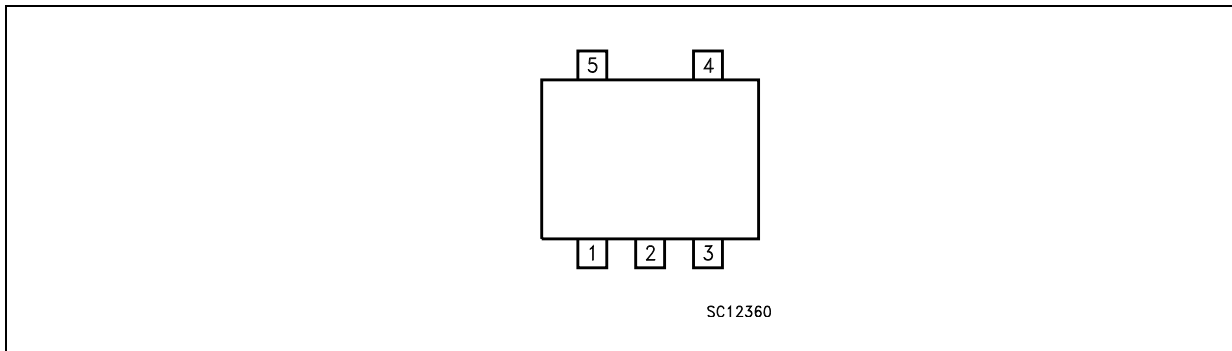

Table 2. Pin description

Pin n°	Symbol	Note
1	SHDN	Shutdown input disables the regulator when it is connected to GND or to positive voltage less than 0.6 V
2	GND	Ground pin internally connected to the die attach flag to decrease the total thermal resistance and increase the package ability to dissipate power
3	Bypass	Bypass pin with 0.1 μ F to improve the noise performance
4	OUT	Output port
5	IN	Input port

3 Maximum ratings

Table 3. Absolute maximum ratings

Symbol	Parameter	Value	Unit
V_I	DC input voltage	16	V
V_{SHDN}	DC input voltage	16	V
I_O	Output current	Internally limited	
T_{STG}	Storage temperature range	-55 to 150	°C
T_{OP}	Operating junction temperature range	-40 to 125	°C

Table 4. Thermal data

Symbol	Parameter	SOT23-5L	Unit
R_{thJC}	Thermal resistance junction-case	81	°C/W
R_{thJA}	Thermal resistance junction-ambient	255	°C/W

4 Electrical characteristics

$T_J = 25\text{ }^\circ\text{C}$, $V_{IN} = V_{OUT} + 1\text{ V}$, $I_{OUT} = 0\text{ mA}$, $V_{SHDN} = 1.8\text{ V}$, $C_I = 1\text{ }\mu\text{F}$, $C_O = 2.2\text{ }\mu\text{F}$, $C_{BYPASS} = 0.1\text{ }\mu\text{F}$ unless otherwise specified.

Table 5. LK112 electrical characteristics

Symbol	Parameter	Test conditions	Min.	Typ.	Max.	Unit
I_q	Quiescent current	On mode (except I_{SHDN})		175	250	μA
		Off mode, $V_I = 8\text{V}$, $V_{SHDN} = 0\text{V}$		0	0.1	μA
V_O	Output voltage	$I_O = 30\text{mA}$	-2		+2	%
ΔV_O	Line regulation	$V_I = V_O + 1\text{V}$ to $V_O + 6\text{V}$, $V_O \leq 5.6\text{V}$		0.7	20	mV
		$V_I = V_O + 1\text{V}$ to $V_O + 6\text{V}$, $V_O > 5.6\text{V}$		0.8	40	mV
ΔV_O	Load regulation	$I_O = 1$ to 60mA		15	30	mV
		$I_O = 1$ to 150mA		25	90	mV
V_d	Dropout voltage	$I_O = 60\text{mA}$ ⁽¹⁾		0.17	0.24	V
		$I_O = 150\text{mA}$ ⁽¹⁾		0.29	0.35	V
I_O	Output current limit		150			mA
SVR	Supply voltage rejection	$V_I = V_O + 1.5\text{V}$, $C_{BYP} = 0.1\text{ }\mu\text{F}$ $C_O = 10\text{ }\mu\text{F}$, $f = 400\text{Hz}$, $I_O = 30\text{mA}$		55		dB
eN	Output noise voltage	B= 10Hz to 80kHz, $C_{BYP} = 0.1\text{ }\mu\text{F}$ $C_O = 10\text{ }\mu\text{F}$, $V_I = V_O + 1.5\text{V}$, $I_O = 60\text{mA}$		30		μVrms
I_{SHDN}	Shutdown input current	$V_{SHDN} = 1.8\text{V}$, output on		12	35	μA
V_{SHDN}	Shutdown input logic	Output on	1.8			V
		Output off			0.6	
$\Delta V_O/T_J$	Output voltage temperature coefficient	$I_O = 10\text{mA}$		0.09		$\text{mV}/^\circ\text{C}$

1. For versions with output voltage more than 2.1 V only.

Note: For version with output voltage less than 2 V, $V_{IN} = 2.4\text{ V}$.

5 Typical characteristics

Unless otherwise specified, $T_J = 25\text{ }^\circ\text{C}$, $C_I = 1\text{ }\mu\text{F}$, $C_O = 2.2\text{ }\mu\text{F}$, $C_{BYP} = 100\text{ nF}$

Figure 3. Output voltage vs. temperature ($V_O = 2.5\text{V}$)

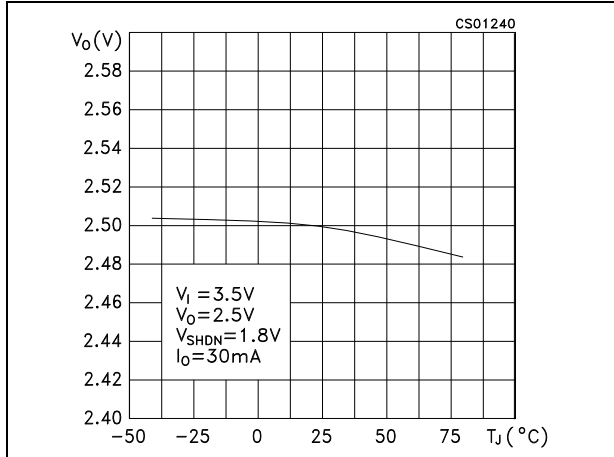

Figure 4. Output voltage vs. temperature ($V_O = 3.8\text{V}$)

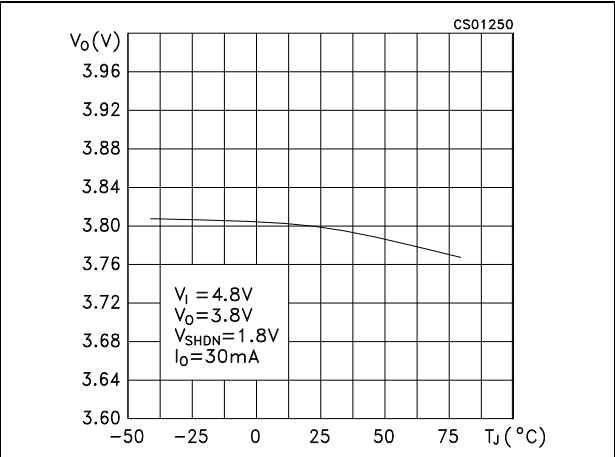

Figure 5. Line regulation vs. temperature

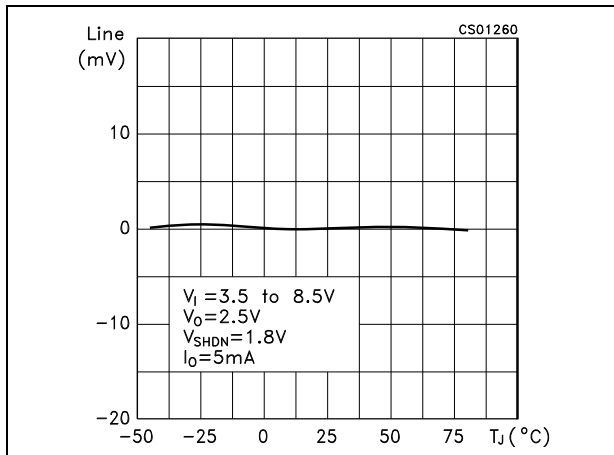

Figure 6. Load regulation vs. temperature

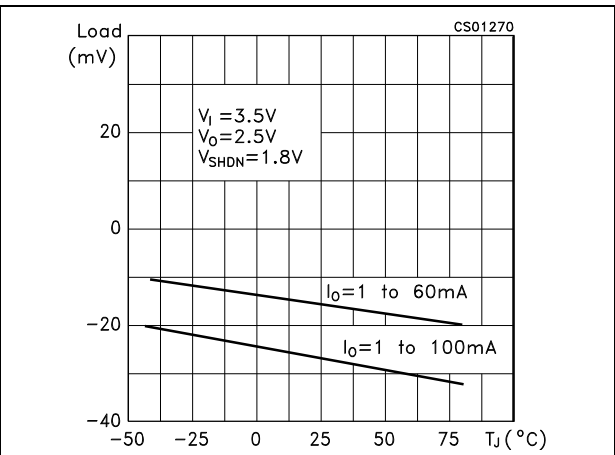

Figure 7. Dropout voltage vs. temperature

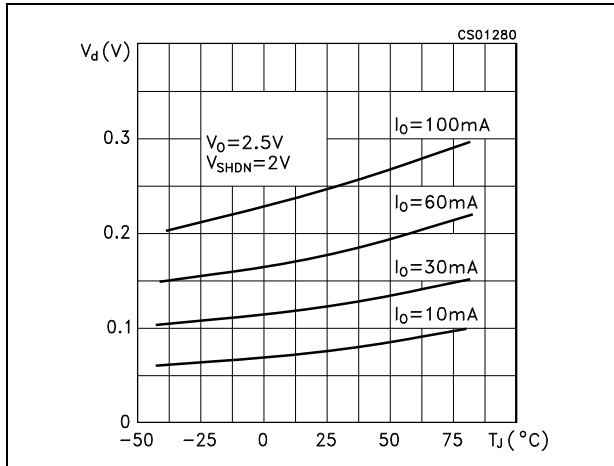

Figure 8. Short-circuit current vs. dropout voltage

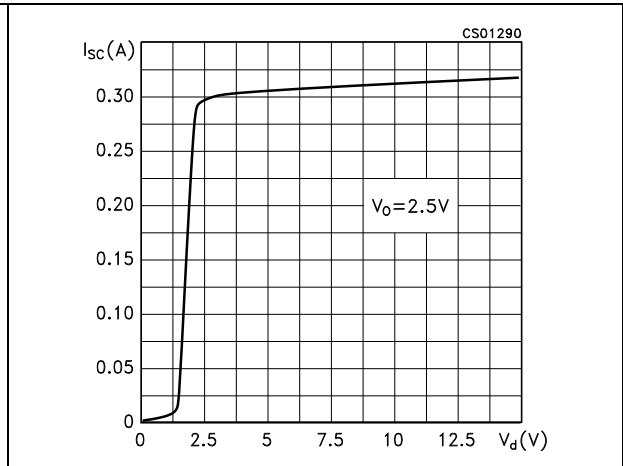

Figure 9. Output voltage vs. input voltage

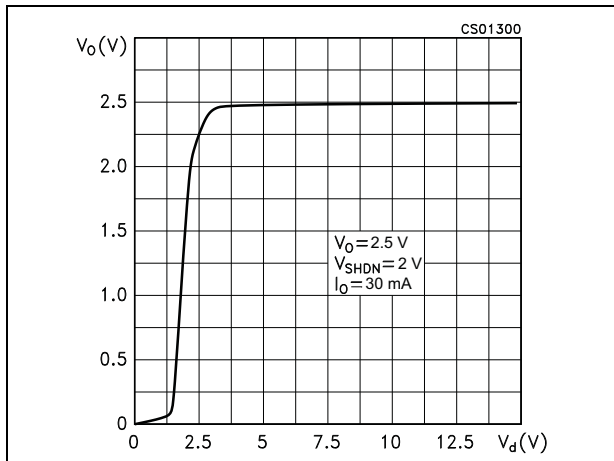

Figure 10. Shutdown voltage vs. temperature

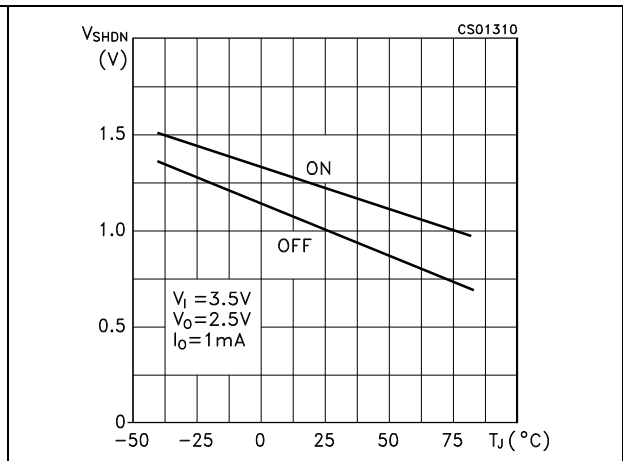

Figure 11. Shutdown current vs. shutdown voltage

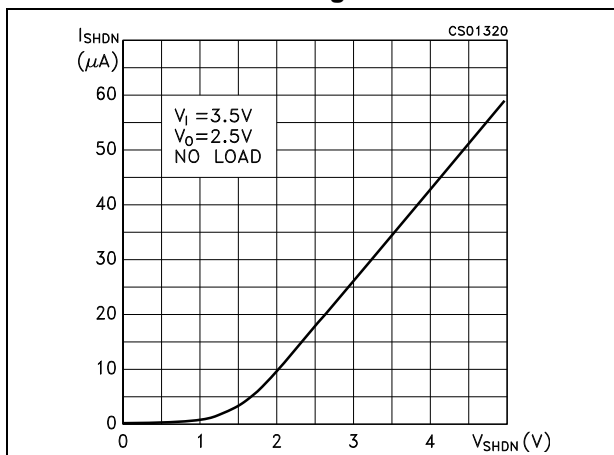

Figure 12. Supply voltage rejection vs. temperature ($V_o = 2.5V$)

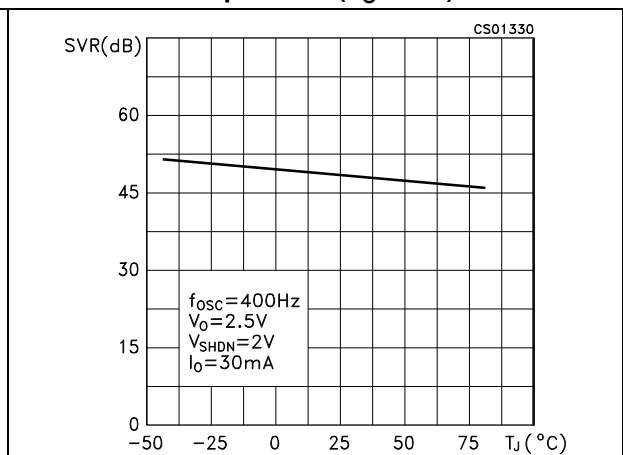

Figure 13. Supply voltage rejection vs. output current

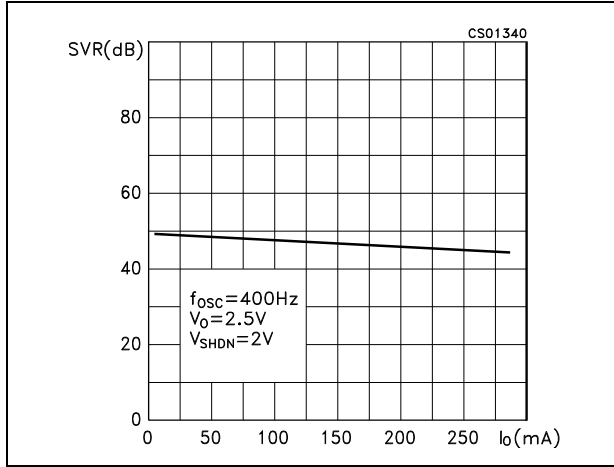

Figure 14. Supply voltage rejection vs. frequency

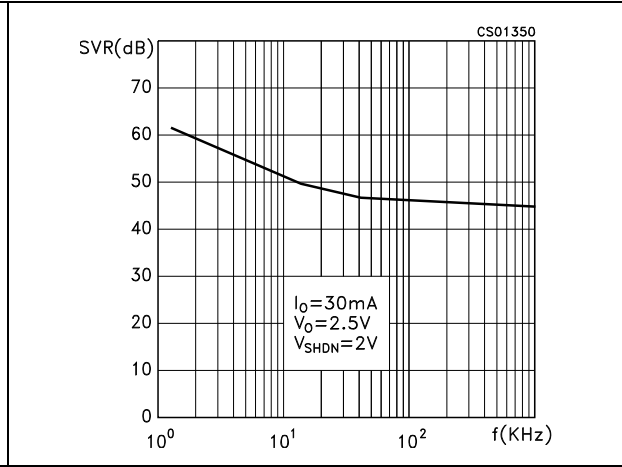

Figure 15. Supply voltage rejection vs. temperature ($V_O=3.8V$)

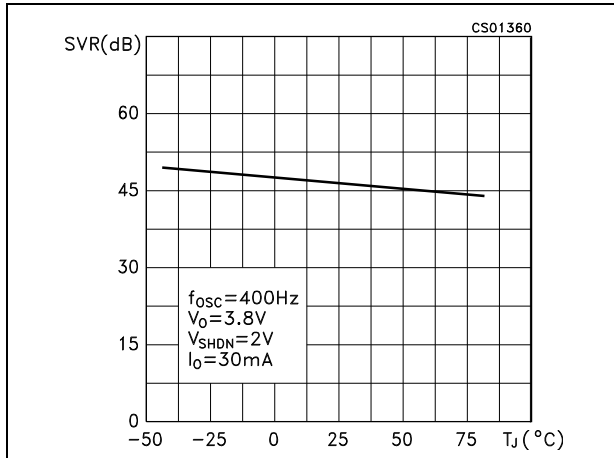

Figure 16. Quiescent current vs. temperature

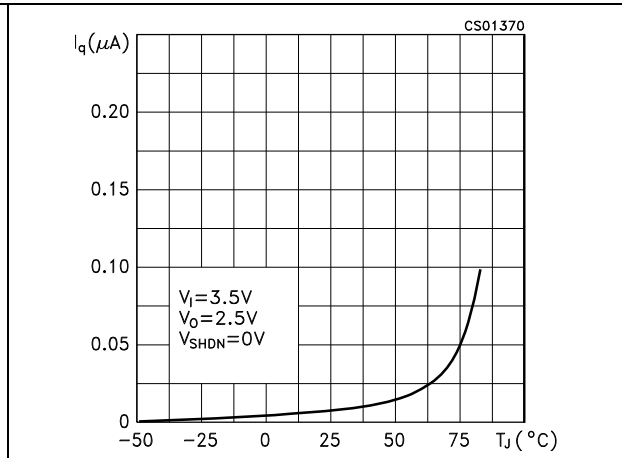

Figure 17. Quiescent current vs. input voltage

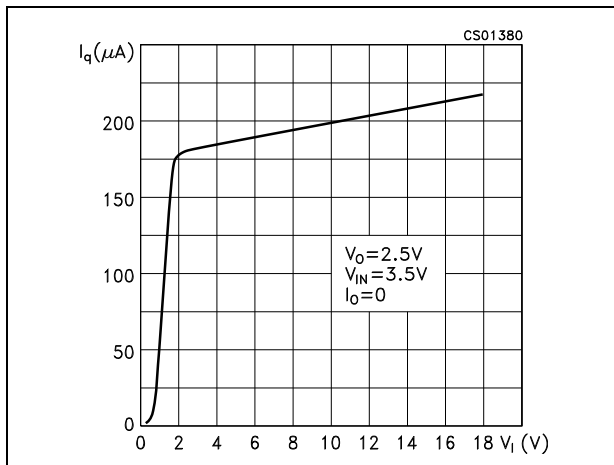

Figure 18. Quiescent current vs. shutdown voltage

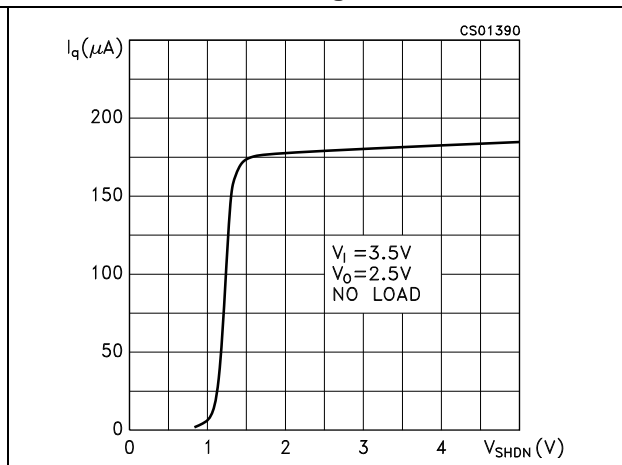

Figure 19. Quiescent current vs. output current Figure 20. Reverse current vs. reverse voltage

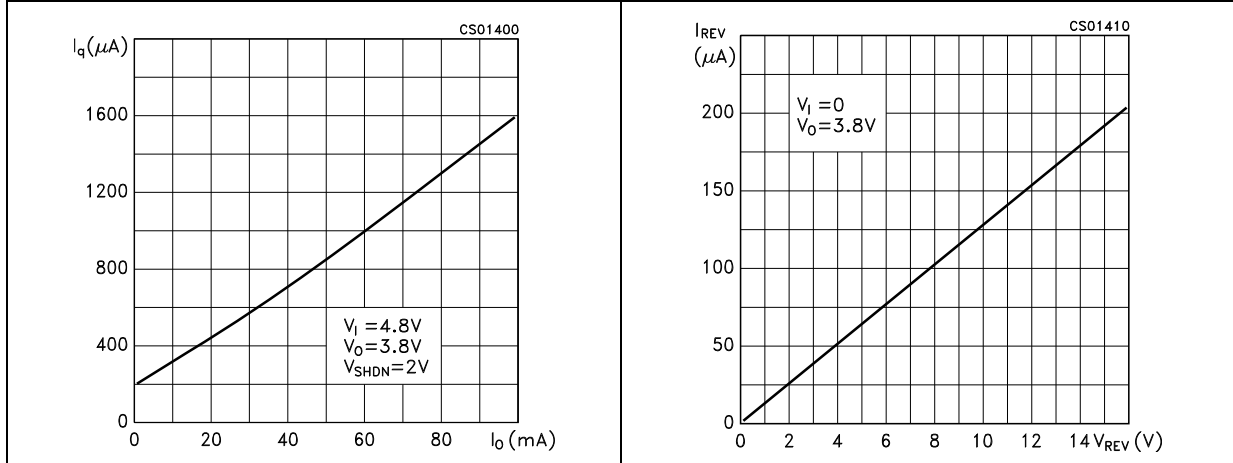

Figure 21. Stability

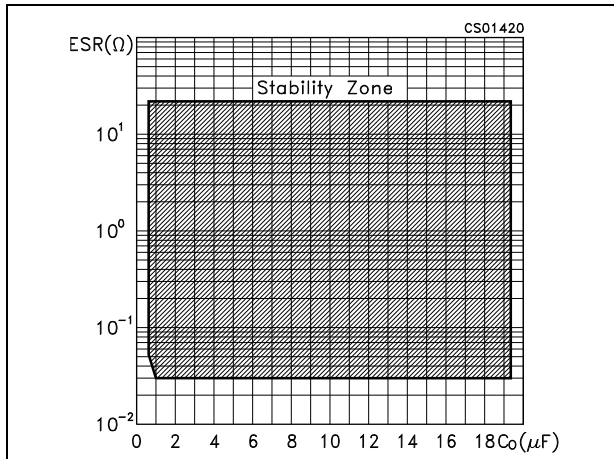

Figure 22. Noise spectrum

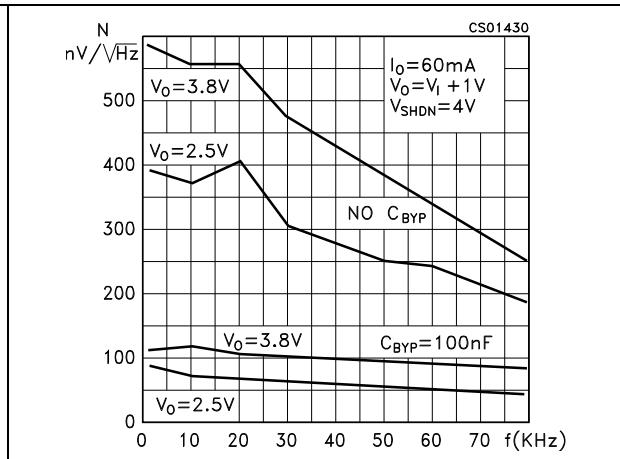

Figure 23. Start-up transient (CBYP = 10 nF)

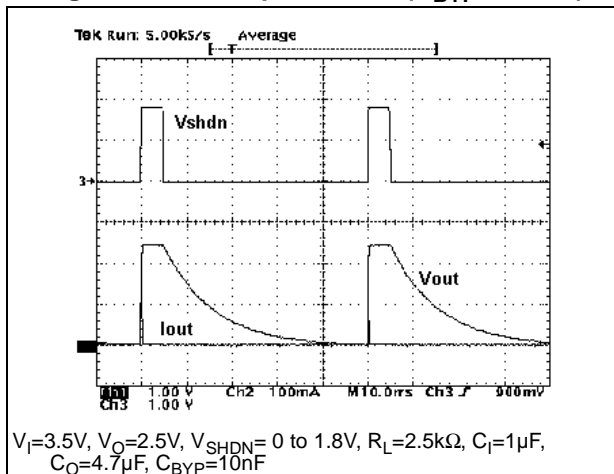

Figure 24. Start-up transient (CBYP = 100 nF)

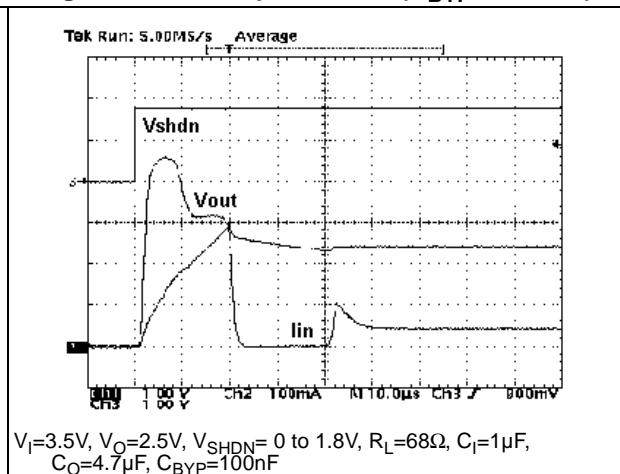

Figure 25. Line transient ($C_o = 100 \mu\text{F}$)

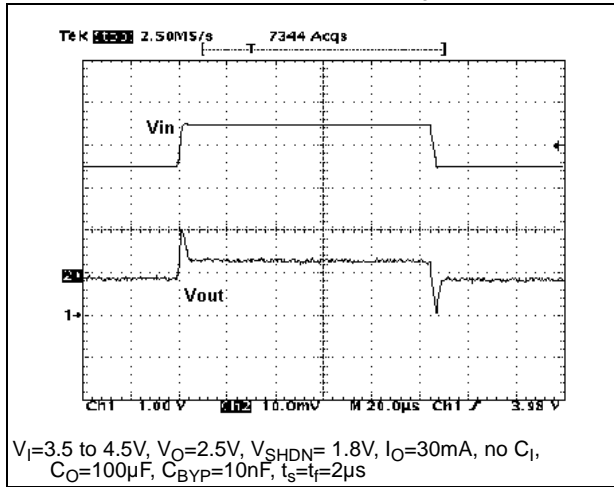

Figure 26. Line transient ($C_o = 10 \mu\text{F}$)

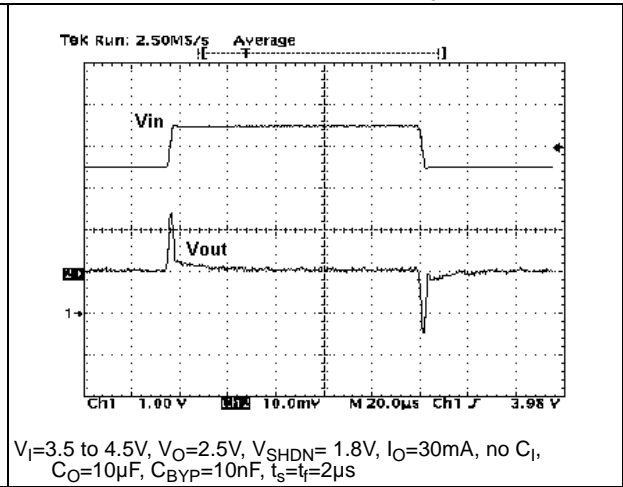

Figure 27. Line transient ($C_o = 1 \mu\text{F}$)

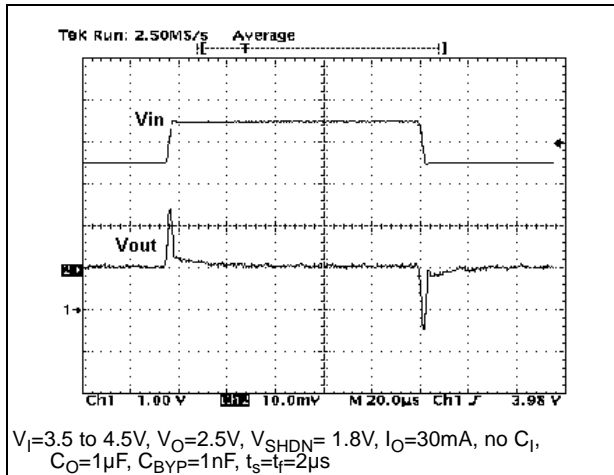

Figure 28. Load transient ($C_o = 2.2 \mu\text{F}$, $C_{\text{BYP}} = 10 \text{ nF}$)

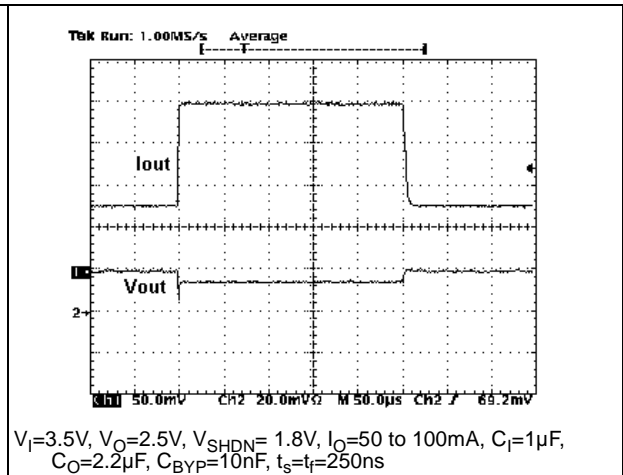

Figure 29. Load transient ($C_O = 10 \mu\text{F}$, $C_{BYP} = 100 \text{ nF}$)

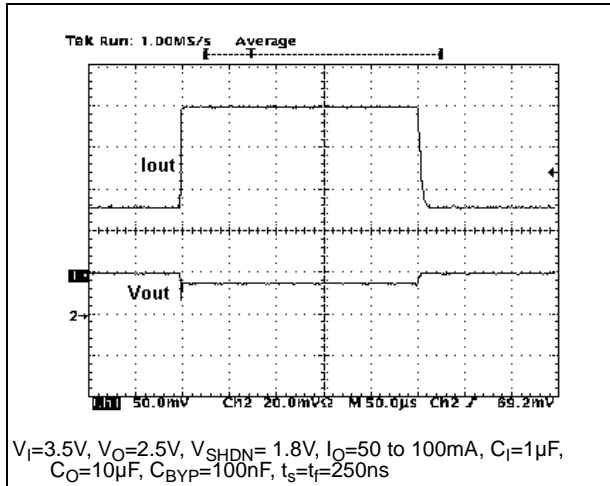
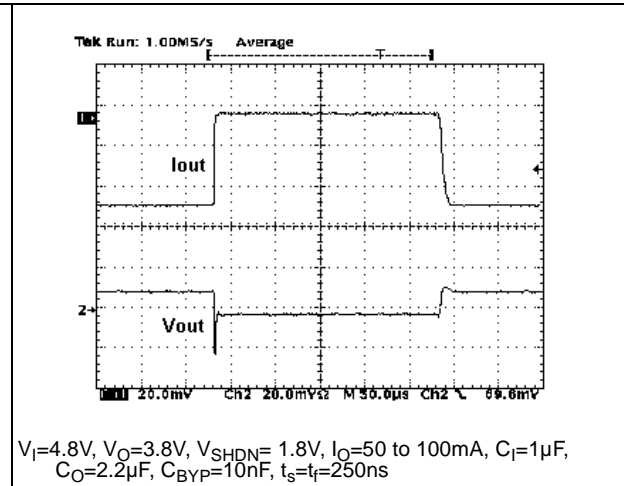

Figure 30. Load transient ($V_O = 3.8 \text{ V}$)



6 Package mechanical data

In order to meet environmental requirements, ST offers these devices in different grades of ECOPACK[®] packages, depending on their level of environmental compliance. ECOPACK[®] specifications, grade definitions and product status are available at: www.st.com. ECOPACK[®] is an ST trademark.

Figure 31. SOT23-5L mechanical drawings

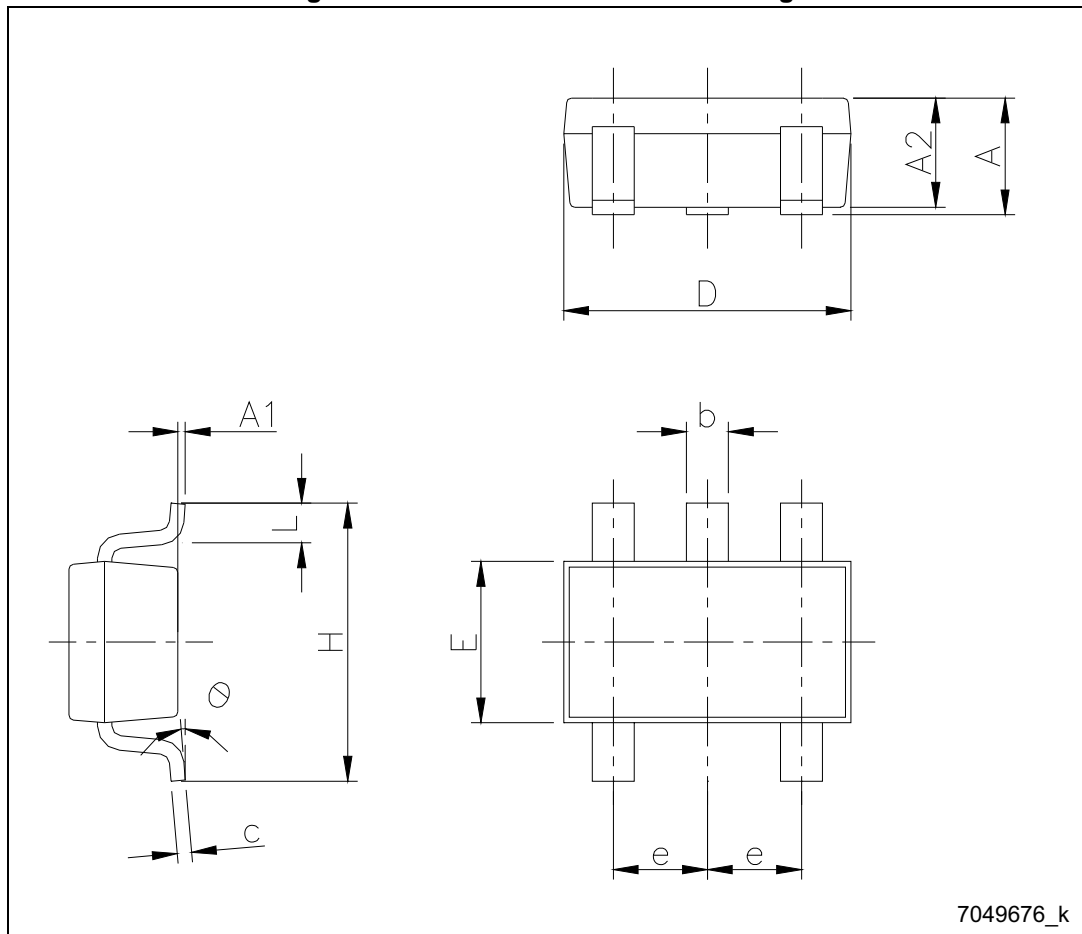
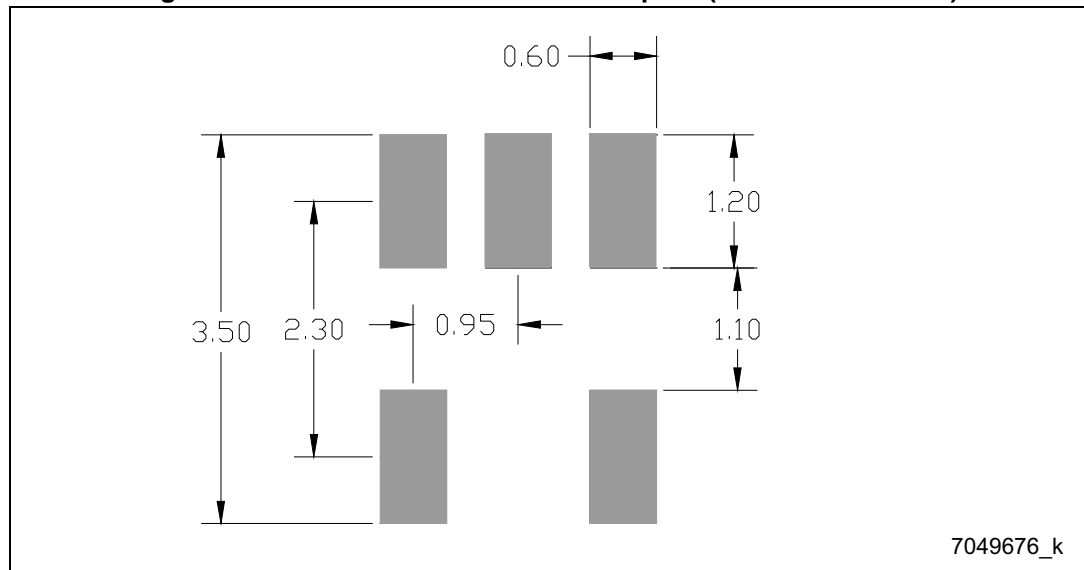

Table 6. SOT23-5L mechanical data

Dim.	mm		
	Min.	Typ.	Max.
A	0.90		1.45
A1	0		0.15
A2	0.90		1.30
b	0.30		0.50
c	2.09		0.20
D		2.95	
E		1.60	
e		0.95	
H		2.80	
L	0.30		0.60
θ	0		8

Figure 32. SOT23-5L recommended footprint (dimensions in mm)



7 Packaging mechanical data

Figure 33. Tape and reel SOT23-5L mechanical drawings

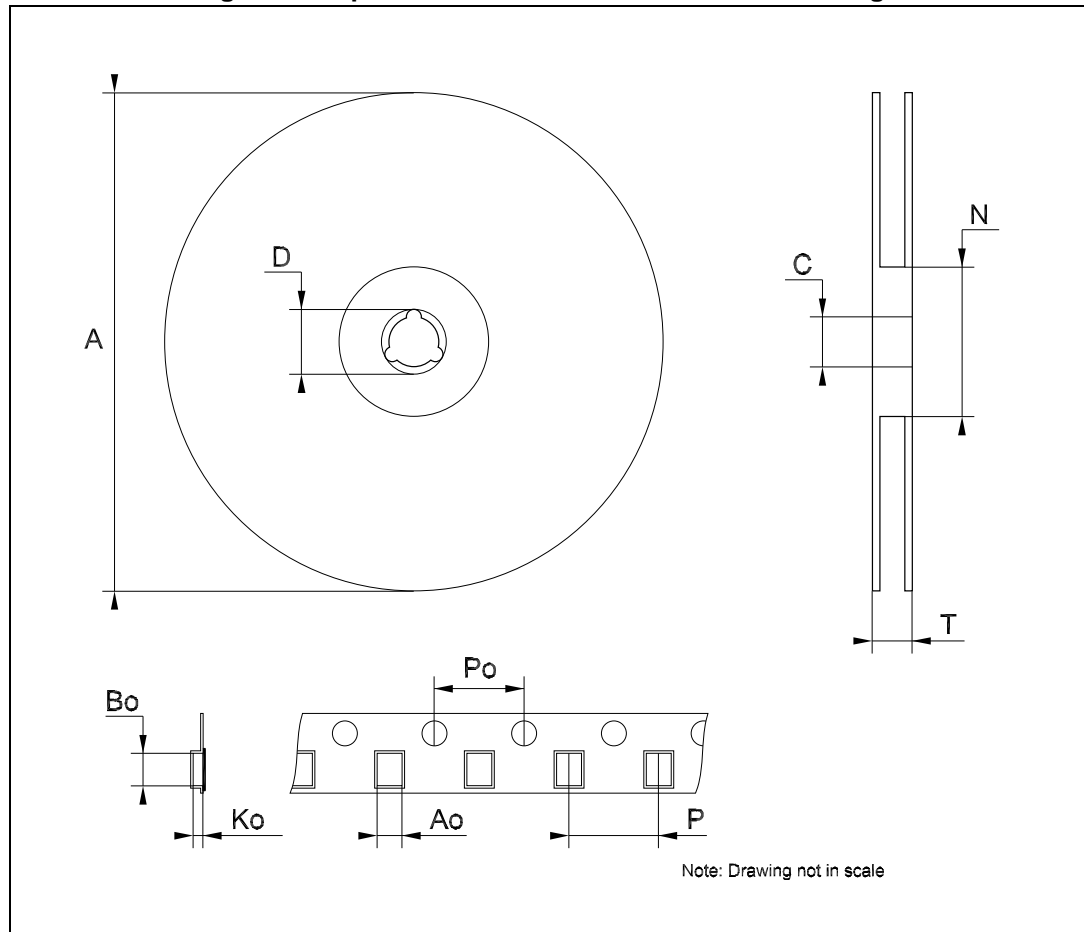

Figure 34. Tape and reel SOT23-5L mechanical data

Dim.	mm		
	Min.	Typ.	Max.
A			180
C	12.8	13.0	13.2
D	20.2		
N	60		
T			14.4
Ao	3.13	3.23	3.33
Bo	3.07	3.17	3.27
Ko	1.27	1.37	1.47
Po	3.9	4.0	4.1
P	3.9	4.0	4.1

8 Revision history

Table 7. Document revision history

Date	Revision	Changes
31-Jan-2005	8	Change maturity code.
13-Jun-2006	9	Order codes updated and new template.
17-Oct-2006	10	The T _{OP} value on table 2 has been updated.
18-Jul-2007	11	Add Table 1 in cover page.
21-Sep-2007	12	Features updated.
11-Dec-2007	13	Modified: Table 1 .
12-Feb-2008	14	Modified: Table 1 .
10-Jul-2008	15	Modified: Table 1 and Table 1 on page 1 .
28-Feb-2011	16	Modified: Table 1 .
24-Apr-2014	17	<p>Changed the part number LK112xx to LK112.</p> <p>Updated the Title in cover page and Table 1: Device summary.</p> <p>Updated the features and description in cover page, Table 2: Pin description, Figure 3: Output voltage vs. temperature (VO= 2.5V), Figure 4: Output voltage vs. temperature (VO= 3.8V), Section 5: Typical characteristics, Section 6: Package mechanical data.</p> <p>Added Section 7: Packaging mechanical data.</p> <p>Minor text changes.</p>

Please Read Carefully:

Information in this document is provided solely in connection with ST products. STMicroelectronics NV and its subsidiaries ("ST") reserve the right to make changes, corrections, modifications or improvements, to this document, and the products and services described herein at any time, without notice.

All ST products are sold pursuant to ST's terms and conditions of sale.

Purchasers are solely responsible for the choice, selection and use of the ST products and services described herein, and ST assumes no liability whatsoever relating to the choice, selection or use of the ST products and services described herein.

No license, express or implied, by estoppel or otherwise, to any intellectual property rights is granted under this document. If any part of this document refers to any third party products or services it shall not be deemed a license grant by ST for the use of such third party products or services, or any intellectual property contained therein or considered as a warranty covering the use in any manner whatsoever of such third party products or services or any intellectual property contained therein.

UNLESS OTHERWISE SET FORTH IN ST'S TERMS AND CONDITIONS OF SALE ST DISCLAIMS ANY EXPRESS OR IMPLIED WARRANTY WITH RESPECT TO THE USE AND/OR SALE OF ST PRODUCTS INCLUDING WITHOUT LIMITATION IMPLIED WARRANTIES OF MERCHANTABILITY, FITNESS FOR A PARTICULAR PURPOSE (AND THEIR EQUIVALENTS UNDER THE LAWS OF ANY JURISDICTION), OR INFRINGEMENT OF ANY PATENT, COPYRIGHT OR OTHER INTELLECTUAL PROPERTY RIGHT.

ST PRODUCTS ARE NOT DESIGNED OR AUTHORIZED FOR USE IN: (A) SAFETY CRITICAL APPLICATIONS SUCH AS LIFE SUPPORTING, ACTIVE IMPLANTED DEVICES OR SYSTEMS WITH PRODUCT FUNCTIONAL SAFETY REQUIREMENTS; (B) AERONAUTIC APPLICATIONS; (C) AUTOMOTIVE APPLICATIONS OR ENVIRONMENTS, AND/OR (D) AEROSPACE APPLICATIONS OR ENVIRONMENTS. WHERE ST PRODUCTS ARE NOT DESIGNED FOR SUCH USE, THE PURCHASER SHALL USE PRODUCTS AT PURCHASER'S SOLE RISK, EVEN IF ST HAS BEEN INFORMED IN WRITING OF SUCH USAGE, UNLESS A PRODUCT IS EXPRESSLY DESIGNATED BY ST AS BEING INTENDED FOR "AUTOMOTIVE, AUTOMOTIVE SAFETY OR MEDICAL" INDUSTRY DOMAINS ACCORDING TO ST PRODUCT DESIGN SPECIFICATIONS. PRODUCTS FORMALLY ESCC, QML OR JAN QUALIFIED ARE DEEMED SUITABLE FOR USE IN AEROSPACE BY THE CORRESPONDING GOVERNMENTAL AGENCY.

Resale of ST products with provisions different from the statements and/or technical features set forth in this document shall immediately void any warranty granted by ST for the ST product or service described herein and shall not create or extend in any manner whatsoever, any liability of ST.

ST and the ST logo are trademarks or registered trademarks of ST in various countries.

Information in this document supersedes and replaces all information previously supplied.

The ST logo is a registered trademark of STMicroelectronics. All other names are the property of their respective owners.

© 2014 STMicroelectronics - All rights reserved

STMicroelectronics group of companies

Australia - Belgium - Brazil - Canada - China - Czech Republic - Finland - France - Germany - Hong Kong - India - Israel - Italy - Japan - Malaysia - Malta - Morocco - Philippines - Singapore - Spain - Sweden - Switzerland - United Kingdom - United States of America

www.st.com

单击下面可查看定价，库存，交付和生命周期等信息

[>>STMicro\(意法半导体\)](#)