

### Description

The STMPS2141, STMPS2151, STMPS2161, STMPS2171 power distribution switches are intended for applications where heavy capacitive loads and short-circuits are likely to be encountered. These devices incorporate 90 mW N-channel MOSFET high-side power switches for power distribution. These switches are controlled by a logic enable input.

When the output load exceeds the current limit threshold or a short is present, the device limits the output current to a safe level by switching into a constant current mode. When continuous heavy overloads and short-circuits increase the power dissipation in the switch, causing the junction temperature to rise, a thermal protection circuit shuts the switch off to prevent damage. Recovery from a thermal shutdown is automatic once the device has cooled sufficiently. Internal circuitry ensures the switch remains off until a valid input voltage is present.

### Features

- 90 mW high-side MOSFET switch
- 500/1000 mA continuous current
- Thermal and short-circuit protection with overcurrent logic output
- Operating range from 2.7 to 5.5 V
- CMOS and TTL compatible enable input
- Undervoltage lockout (UVLO)
- 12  $\mu$ A maximum standby supply current
- Ambient temperature range, -40 to 85 °C
- ESD protection: 8 kV HBM
- Reverse current protection
- Fault blanking
- UL recognized components (UL file number: E354278)

Table 1. Device summary

Order codes			Rated continuous output current (mA)	Enable
SO-8	SOT23-5L	MSOP8 <sup>(1)</sup>		
STMPS2141MTR	STMPS2141STR	STMPS2141TTR	500	Active low
STMPS2151MTR	STMPS2151STR	STMPS2151TTR	500	Active high
STMPS2161MTR	STMPS2161STR	STMPS2161TTR	1000	Active low
STMPS2171MTR	STMPS2171STR	STMPS2171TTR	1000	Active high

1. MSOP8 package is also known as "TSSOP8".

# Contents

<b>1</b>	<b>Block diagram</b> .....	<b>7</b>
<b>2</b>	<b>Pin settings</b> .....	<b>8</b>
2.1	Pin connections .....	8
2.2	Pin description .....	8
<b>3</b>	<b>Functional description</b> .....	<b>9</b>
3.1	Fault blanking .....	9
3.2	Overcurrent/overtemperature protection .....	9
3.3	Fault conditions .....	9
3.4	Reversed current blocking .....	10
3.5	UVLO .....	10
<b>4</b>	<b>Ambient temperature</b> .....	<b>11</b>
<b>5</b>	<b>Maximum ratings</b> .....	<b>12</b>
5.1	Absolute maximum ratings .....	12
5.2	Recommended operating conditions .....	12
<b>6</b>	<b>Electrical specifications</b> .....	<b>13</b>
<b>7</b>	<b>Detail device characteristics</b> .....	<b>17</b>
7.1	STMPS2141, STMPS2151 additional electrical charts .....	17
7.1.1	Turn-on/off characteristics at $V_{OUT} = 5.0\text{ V}$ .....	17
7.1.2	Turn-on/off characteristics at $V_{OUT} = 3.0\text{ V}$ .....	18
7.1.3	UVLO .....	19
7.1.4	OC protection characteristics .....	19
7.1.5	Other electrical characteristics .....	20
7.2	STMPS2161, STMPS2171 electrical charts .....	23
7.2.1	Turn-on/off characteristics at $V_{OUT} = 5.0\text{ V}$ .....	23
7.2.2	Turn-on/off characteristics at $V_{OUT} = 3.0\text{ V}$ .....	24
7.2.3	UVLO .....	25
7.2.4	OC protection characteristics .....	25
7.2.5	Other electrical characteristics .....	26

---

8	Package mechanical data .....	29
9	Ordering information .....	37
10	Revision history .....	38

## List of tables

Table 1.	Device summary	1
Table 2.	Pin description	7
Table 3.	Fault conditions	8
Table 4.	SOT23-5L (191 °C/W)	10
Table 5.	MSOP8 (220 °C/W)	10
Table 6.	SO-8 (160 °C/W)	10
Table 7.	Absolute maximum ratings	11
Table 8.	Recommended operating conditions	11
Table 9.	SOT-23-5L electrical characteristics	12
Table 10.	MSO8P/SO-8 electrical characteristics	12
Table 11.	Current limit characteristics ( $V_{IN} = 5.5\text{ V}$ , $I_{OUT} = \text{rated current}$ , $T_J = 25\text{ °C}$ , unless otherwise specified)	13
Table 12.	Supply current characteristics ( $V_{IN} = 5.5\text{ V}$ , $I_{OUT} = \text{rated current}$ , $T_J = 25\text{ °C}$ , unless otherwise specified)	13
Table 13.	Thermal characteristics ( $V_{IN} = 5.5\text{ V}$ , $I_{OUT} = \text{rated current}$ , $T_J = 25\text{ °C}$ , unless otherwise specified)	14
Table 14.	UVLO characteristics ( $V_{IN} = 5.5\text{ V}$ , $I_{OUT} = \text{rated current}$ , $T_J = 25\text{ °C}$ , unless otherwise specified)	14
Table 15.	FAULT pin characteristics ( $V_{IN} = 5.5\text{ V}$ , $I_{OUT} = \text{rated current}$ , $T_J = 25\text{ °C}$ , unless otherwise specified)	14
Table 16.	EN pin characteristics ( $V_{IN} = 5.5\text{ V}$ , $I_{OUT} = \text{rated current}$ , $T_J = 25\text{ °C}$ , unless otherwise specified)	14
Table 17.	SOT23-5L package mechanical data	28
Table 18.	SOT23-5L footprint dimensions	29
Table 19.	SO-8 mechanical data	31
Table 20.	MSOP8 package mechanical data	33
Table 21.	Reel mechanical data	35
Table 22.	Order codes	36
Table 23.	Document revision history	37

# List of figures

Figure 1. Block diagram . . . . . 7

Figure 2. SOT23-5L, SO-8 and MSOP8 pin connections . . . . . 8

Figure 3. Voltage output turn-on delay time (STMP2141/2151, 5 V) . . . . . 17

Figure 4. Voltage output turn-off delay time (STMP2141/2151, 5 V) . . . . . 17

Figure 5. Current output turn-on delay time (STMP2141/2151, 5 V) . . . . . 17

Figure 6. Current output turn-off delay time (STMP2141/2151, 5 V) . . . . . 17

Figure 7. Voltage output turn-on delay time (STMP2141/2151, 3 V) . . . . . 18

Figure 8. Voltage output turn-off delay time (STMP2141/2151, 3 V) . . . . . 18

Figure 9. Current output turn-on delay time (STMP2141/2151, 3 V) . . . . . 18

Figure 10. Current output turn-off delay time (STMP2141/2151, 3 V) . . . . . 18

Figure 11. UVLO rising (STMP2141/2151) . . . . . 19

Figure 12. UVLO falling (STMP2141/2151) . . . . . 19

Figure 13. OC protection at  $V_{OUT} = 3.0\text{ V}$  (STMP2141/2151) . . . . . 19

Figure 14. OC protection at  $V_{OUT} = 3.0\text{ V}$  (STMP2141/2151 - details) . . . . . 19

Figure 17.  $I_{CC}$  vs.  $V_{IN}$  (enabled) (STMP2141/2151) . . . . . 20

Figure 18.  $I_{CC}$  vs. temperature (enabled) (STMP2141/2151) . . . . . 20

Figure 15. OC protection at  $V_{OUT} = 5.0\text{ V}$  (STMP2141/2151) . . . . . 20

Figure 16. OC protection at  $V_{OUT} = 5.0\text{ V}$  (STMP2141/2151 - details) . . . . . 20

Figure 19.  $I_{CC}$  vs.  $V_{IN}$  (disabled) (STMP2141/2151) . . . . . 20

Figure 20.  $I_{CC}$  vs. temperature (disabled) (STMP2141/2151) . . . . . 20

Figure 21.  $R_{ON}$  vs.  $V_{IN}$  (STMP2141/2151) . . . . . 21

Figure 22.  $R_{ON}$  vs. temperature (STMP2141/2151) . . . . . 21

Figure 23.  $I_{OS}$  vs. temperature (STMP2141/2151) . . . . . 21

Figure 24. Switch leakage vs. temperature (STMP2141/2151) . . . . . 21

Figure 25. Output rise time vs.  $V_{IN}$  (STMP2141/2151) . . . . . 21

Figure 26. Output fall time vs.  $V_{IN}$  (STMP2141/2151) . . . . . 21

Figure 27. UVLO vs. temperature (STMP2141/2151) . . . . . 22

Figure 28. Voltage output turn-on delay time (STMP2161/2171, 5 V) . . . . . 23

Figure 29. Voltage output turn-off delay time (STMP2161/2171, 5 V) . . . . . 23

Figure 30. Current output turn-on delay time (STMP2161/2171, 5 V) . . . . . 23

Figure 31. Current output turn-off delay time (STMP2161/2171, 5 V) . . . . . 23

Figure 32. Voltage output turn-on delay time (STMP2161/2171, 3 V) . . . . . 24

Figure 33. Voltage output turn-off delay time (STMP2161/2171, 3 V) . . . . . 24

Figure 34. Current output turn-on delay time (STMP2161/2171, 3 V) . . . . . 24

Figure 35. Current output turn-off delay time (STMP2161/2171, 3 V) . . . . . 24

Figure 36. UVLO rising (STMP2161/2171) . . . . . 25

Figure 37. UVLO falling (STMP2161/2171) . . . . . 25

Figure 38. OC protection at  $V_{OUT} = 3.0\text{ V}$  (STMP2161/2171) . . . . . 25

Figure 39. OC protection at  $V_{OUT} = 3.0\text{ V}$  (STMP2161/2171- detail) . . . . . 25

Figure 42.  $I_{CC}$  vs.  $V_{IN}$  (enabled) (STMP2161/2171) . . . . . 26

Figure 43.  $I_{CC}$  vs. temperature (enabled) (STMP2161/2171) . . . . . 26

Figure 40. OC protection at  $V_{OUT} = 5.0\text{ V}$  (STMP2161/2171) . . . . . 26

Figure 41. OC protection at  $V_{OUT} = 5.0\text{ V}$  (STMP2161/2171- detail) . . . . . 26

Figure 44.  $I_{CC}$  vs.  $V_{IN}$  (disabled) (STMP2161/2171) . . . . . 26

Figure 45.  $I_{CC}$  vs. temperature (disabled) (STMP2161/2171) . . . . . 26

Figure 46.  $R_{ON}$  vs.  $V_{IN}$  (STMP2161/2171) . . . . . 27

Figure 47.  $R_{ON}$  vs. temperature (STMP2161/2171) . . . . . 27

Figure 48.  $I_{OS}$  vs. temperature (STMP2161/2171) . . . . . 27



---

Figure 49.	Switch leakage vs. temperature (STMPS2161/2171) . . . . .	27
Figure 50.	Output rise time vs. $V_{IN}$ (STMPS2161/2171) . . . . .	27
Figure 51.	Output fall time vs. $V_{IN}$ (STMPS2161/2171) . . . . .	27
Figure 52.	UVLO vs. temperature (STMPS2161/2171) . . . . .	28
Figure 53.	SOT23-5L package outline . . . . .	29
Figure 54.	SOT23-5L footprint recommendations . . . . .	30
Figure 55.	SOT23-5L carrier tape . . . . .	31
Figure 56.	SO-8 package outline . . . . .	32
Figure 57.	SO-8 carrier tape . . . . .	33
Figure 58.	MSOP8 package outline . . . . .	34
Figure 59.	MSOP8 carrier tape . . . . .	34
Figure 60.	Reel information . . . . .	36

# 1 Block diagram

Figure 1. Block diagram

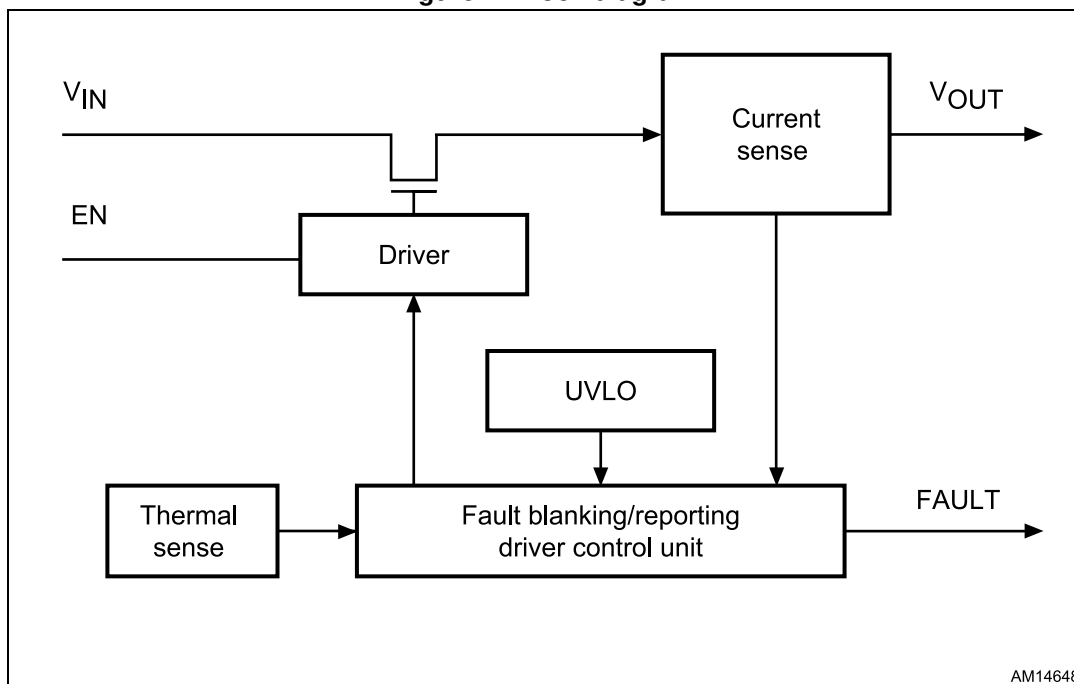

## 2 Pin settings

### 2.1 Pin connections

Figure 2. SOT23-5L, SO-8 and MSOP8 pin connections

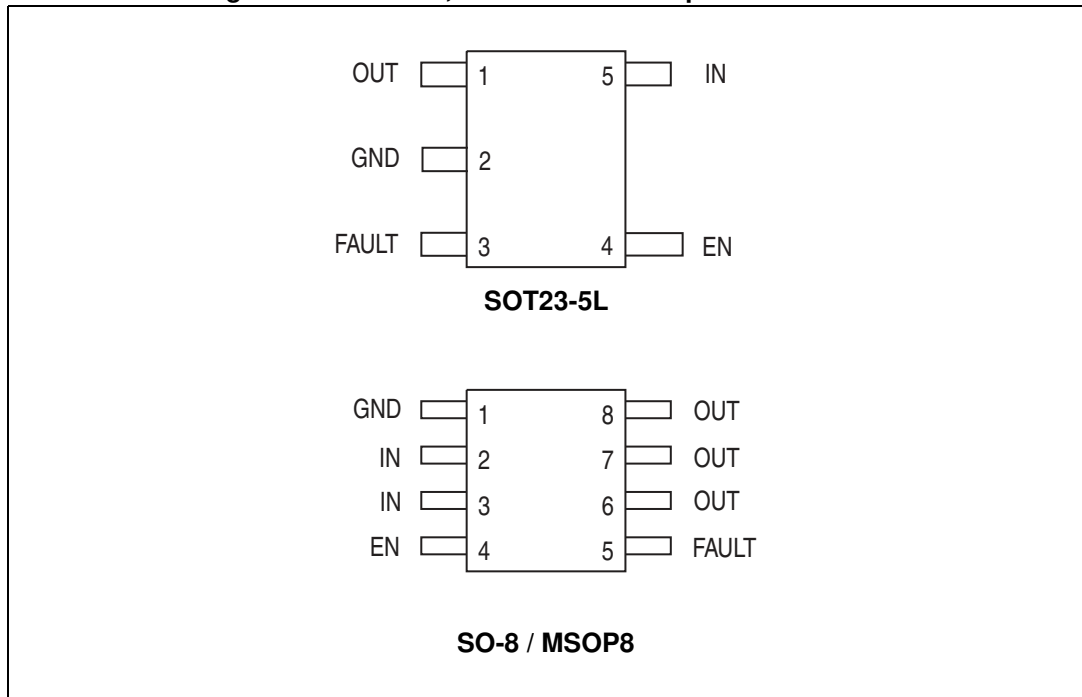

### 2.2 Pin description

Table 2. Pin description

Pin number			Name	Function
SO-8	MSOP8	SOT23-5L		
1	1	2	GND	Ground
2	2	5	IN	2.7 - 5.5 V input
3	3	-	IN	2.7 - 5.5 V input
4	4	4	EN	Enable for power switch
5	5	3	FAULT	Open drain FAULT indicator, active low
6	6	1	OUT	Output of power switch
7	7	-	OUT	Output of power switch
8	8	-	OUT	Output of power switch



### 3 Functional description

#### 3.1 Fault blanking

The STMPS devices feature a 10 ms fault blanking. Fault blanking allows current limit faults, including momentary short-circuit faults that occur when hot-swapping a capacitive load, and also ensures that no fault is issued during power-up. When a load transient causes the device to enter current limit, an internal counter starts. If the load fault persists beyond the 10 ms fault blanking timeout, the FAULT output asserts “low”. Load transient faults less than 10 ms (typ.) do not cause a FAULT output assertion. Only current limit faults are blanked. Die overtemperature faults and input voltage drops below the UVLO threshold cause an immediate fault output.

#### 3.2 Overcurrent/overtemperature protection

In overcurrent or short-circuit condition, the switch limits the current at a value of about 120% of the rated current. If the temperature of the die goes above the limit value, the switch turns off.

#### 3.3 Fault conditions

In power switch applications, 4 types of fault conditions are common. These fault conditions and the response of the STMPS21x1 power switches are described in [Table 3](#).

**Table 3. Fault conditions**

Fault	Condition	STMPS21x1 action
Short-circuit	Output shorted to GND via resistance path of < 1 Ω, causing a rapid current surge.	Reduces output voltage to reduce the current. Asserts FAULT pin after a blanking period
Overcurrent	Output connected to a load that sinks current above threshold.	Reduces output voltage to reduce the current. Asserts FAULT pin after a blanking period.
Overheating	Temperature of junction exceeds 135 °C due to any reason.	Turn OFF output until temperature falls below 125 °C. Asserts FAULT pin immediately.
Undervoltage	Input voltage drops below the UVLO threshold.	Turn OFF output until input voltage rises above the UVLO threshold plus hysteresis. Asserts FAULT pin immediately.

### 3.4 Reversed current blocking

When the switch is OFF (disabled through the EN pin), or when the STMPS device is unpowered ( $V_{IN} = 0\text{ V}$ ) the switch behaves as an Hi-Z at the output pin, ensuring that no reverse current will flow into the device when  $V_{IN} < V_{OUT}$ .

*Note:* In the case where the switch is ON, and a voltage higher than  $V_{IN}$  is applied to the OUT pin, a reverse current occurs. This operating condition is not allowed.

### 3.5 UVLO

When the input voltage drops below critical values, the power switch turns off to prevent improper operation due to low voltage.

## 4 Ambient temperature

In "Enable" operating mode, an amount of power is dissipated as heat in the power switch due to the on-resistance. The power dissipation is:  $P = I^2R$ .

**Table 4. SOT23-5L (191 °C/W)**

Part number	Max. current	Max. $R_{ON}$ at 5 V	Power dissipation	Temperature difference (junction - ambient)	Maximum ambient temperature (at junction temperature 125 °C)
STMPS2141	0.50 A	135 mΩ	33.8 mW	6.5	118.5
STMPS2151					
STMPS2161	1.00 A	135 mΩ	135.0 mW	25.8	99.2
STMPS2171					

**Table 5. MSOP8 (220 °C/W)**

Part number	Max. current	Max. $R_{ON}$ at 5 V	Power dissipation	Temperature difference (junction - ambient)	Maximum ambient temperature (at junction temperature 125 °C)
STMPS2141	0.50 A	140 mΩ	35.0 mW	7.7	117.3
STMPS2151					
STMPS2161	1.00 A	140 mΩ	140.0 mW	30.8	94.2
STMPS2171					

**Table 6. SO-8 (160 °C/W)**

Part number	Max. current	Max. $R_{ON}$ at 5 V	Power dissipation	Temperature difference (junction - ambient)	Maximum ambient temperature (at junction temperature 125 °C)
STMPS2141	0.50 A	140 mΩ	35.0 mW	5.6	119.4
STMPS2151					
STMPS2161	1.00 A	140 mΩ	140.0 mW	22.4	102.6
STMPS2171					

## 5 Maximum ratings

Stressing the device above the rating listed in [Table 7: Absolute maximum ratings](#) may cause permanent damage to the device. These are stress ratings only and operation of the device at these or any other conditions above those indicated in [Section 5.2: Recommended operating conditions](#) of this specification is not implied. Exposure to absolute maximum rating conditions for extended periods may affect device reliability.

### 5.1 Absolute maximum ratings

Table 7. Absolute maximum ratings

Symbol	Parameter	Value	Unit
$V_{IN}$	Input voltage range	-0.3 – 6.0	V
$V_{OUT}$	Output voltage range	-0.3 – ( $V_{IN} + 0.3$ )	V
$V_{IENX}$	EN Input voltage range	-0.3 – 6.0	V
$I_{OUT}$	Continuous output current	Internally limited	-
ESD	ESD protection level (HBM)	8	kV
$T_J$	Junction operating temperature	-40 to 125	°C
$T_{STG}$	Storage temperature	-55 to 150	°C
$T_R$	Thermal resistance (MSOP8)	220	°C/W
$T_R$	Thermal resistance (SOT23-5L)	191	°C/W
$T_R$	Thermal resistance (SO-8)	160	°C/W

### 5.2 Recommended operating conditions

Table 8. Recommended operating conditions

Symbol	Parameter	Value			Unit
		Min.	Typ.	Max.	
$V_{IN}$	Input voltage	2.7	5.0	5.5	V
$V_{OUT}$	Output voltage	0	5.0	5.5	V
$I_{OUT}$ (STMPS2141 STMPS2151)	Continuous output current	0	-	500	mA
$I_{OUT}$ (STMPS2161 STMPS2171)	Continuous output current	0	-	1000	mA

## 6 Electrical specifications

**Table 9. SOT-23-5L electrical characteristics**

Symbol	Parameter	Test condition	Value			Unit
			Min.	Typ.	Max.	
R <sub>ON</sub>	Static drain source ON state resistance SOT23-5L package load = 500 mA (STMP2141/ STMP2151) load = 1000 mA (STMP2161/ STMP2171)	V <sub>IN</sub> = 2.7 V; T <sub>J</sub> = 25 °C;	-	120	160	mΩ
		V <sub>IN</sub> = 5.0 V; T <sub>J</sub> = 25 °C;	-	90	110	mΩ
R <sub>ON</sub>	Static drain source ON state resistance	V <sub>IN</sub> = 2.7 V; -40 < T <sub>J</sub> < 125 °C	-	-	200	mΩ
		V <sub>IN</sub> = 5.0 V; -40 < T <sub>J</sub> < 125 °C	-	-	135	
t <sub>r</sub>	Output rise time	V <sub>IN</sub> = 5.0 V R <sub>L</sub> = 10 Ω C <sub>L</sub> = 1 μF	0.05	-	2	ms

**Table 10. MSO8P/SO-8 electrical characteristics**

Symbol	Parameter	Test condition	Value			Unit
			Min.	Typ.	Max.	
R <sub>ON</sub>	Static drain source ON state resistance SO-8 and MSO8 package load = 500 mA (STMP2141/ STMP2151) load = 1000 mA (STMP2161/ STMP2171)	V <sub>IN</sub> = 2.7 V; T <sub>J</sub> = 25 °C	-	130	170	mΩ
		V <sub>IN</sub> = 5.0 V; T <sub>J</sub> = 25 °C	-	110	125	mΩ
R <sub>ON</sub>	Static drain source ON state resistance	V <sub>IN</sub> = 2.7 V -40 < T <sub>J</sub> < 125 °C	-	-	200	mΩ
		V <sub>IN</sub> = 5.0 V -40 < T <sub>J</sub> < 125 °C	-	-	140	
t <sub>r</sub>	Output rise time	V <sub>IN</sub> = 5.0 V R <sub>L</sub> = 10 Ω C <sub>L</sub> = 1 μF	0.05	-	2	ms

**Table 11. Current limit characteristics**  
 ( $V_{IN} = 5.5\text{ V}$ ,  $I_{OUT} = \text{rated current}$ ,  $T_J = 25\text{ °C}$ , unless otherwise specified)

Symbol	Parameter	Test condition	Value			Unit
			Min.	Typ.	Max.	
$I_{OS}$ (STMPS2141 STMPS2151)	Overcurrent limiting threshold	$V_{IN} = 5.5\text{ V}$ $V_{OUT} = 5.0\text{ V}$	0.60	0.80	1.00	A
$I_{OS}$ (STMPS2161 STMPS2171)	Overcurrent limiting threshold		1.10	1.50	1.90	A
$I_{OS}$ (2141, 2151)	Short-circuit output current	$V_{IN} = 5.5\text{ V}$ , OUT connected to GND, device enabled into short-circuit	-	-	0.9	A
$I_{OS}$ (2161, 2171)	Short-circuit output current		-	-	1.8	A

**Table 12. Supply current characteristics**  
 ( $V_{IN} = 5.5\text{ V}$ ,  $I_{OUT} = \text{rated current}$ ,  $T_J = 25\text{ °C}$ , unless otherwise specified)

Symbol	Parameter	Test condition	Value			Unit
			Min.	Typ.	Max.	
$I_{OFF}$	Switch turned off	No load	-	6.0	12	$\mu\text{A}$
		No load; $-40 < T_J < 125\text{ °C}$	-	-	15	
$I_{ON}$	Switch turned on	No load	-	40	60	$\mu\text{A}$
		No load; $-40 < T_J < 125\text{ °C}$	-	-	70	
$I_{leakage}$	Output leakage current <sup>(1)</sup>	Output grounded, switch is OFF	-	-	2	$\mu\text{A}$
		Output grounded, switch is OFF; $-40 < T_J < 125\text{ °C}$	-	-	5	
$I_{reverse}$	Reversed leakage current	Switch is off, $V_{IN} < V_{OUT}$ , output connected to 5.5 V, 25 °C	-	0.5	2	$\mu\text{A}$
		Switch is off, $V_{IN} < V_{OUT}$ , output connected to 5.5 V, 125 °C	-	0.5	3	

1.  $I_{leakage} = I_{OFF-ground} - I_{OFF}$ , where  $I_{OFF-ground}$  = current into  $V_{IN}$  when switch is off and output is grounded.

**Table 13. Thermal characteristics**  
 ( $V_{IN} = 5.5\text{ V}$ ,  $I_{OUT} = \text{rated current}$ ,  $T_J = 25\text{ }^\circ\text{C}$ , unless otherwise specified)

Symbol	Parameter	Test condition	Value			Unit
			Min.	Typ.	Max.	
T1	Thermal shutdown threshold		-	-	145	°C
T2	Recovery from thermal shutdown		120	-	-	°C
Hysteresis	-		-	14	-	°C

**Table 14. UVLO characteristics**  
 ( $V_{IN} = 5.5\text{ V}$ ,  $I_{OUT} = \text{rated current}$ ,  $T_J = 25\text{ }^\circ\text{C}$ , unless otherwise specified)

Symbol	Parameter	Test condition	Value			Unit
			Min.	Typ.	Max.	
$V_{UVLO}$	Undervoltage lockout threshold		2.0	-	2.5	V
Hysteresis	-		40	75	110	mV

**Table 15. FAULT pin characteristics**  
 ( $V_{IN} = 5.5\text{ V}$ ,  $I_{OUT} = \text{rated current}$ ,  $T_J = 25\text{ }^\circ\text{C}$ , unless otherwise specified)

Symbol	Parameter	Test condition	Value			Unit
			Min.	Typ.	Max.	
OC blanking	FAULT assertion and de-assertion		4	8	15	ms
$V_{OUT}$	Output low voltage	$I_{OUT} = 5\text{ mA}$	-	-	0.4	V
$I_{OFF}$	Off current	$V_{FAULT} = 2.7\text{ V}, 5.5\text{ V}$ (no OC condition)	-	-	1.0	μA

**Table 16. EN pin characteristics**  
 ( $V_{IN} = 5.5\text{ V}$ ,  $I_{OUT} = \text{rated current}$ ,  $T_J = 25\text{ }^\circ\text{C}$ , unless otherwise specified)

Symbol	Parameter	Test condition	Value			Unit
			Min.	Typ.	Max.	
$V_{IH}$	High level input voltage	$V_{IN} = 2.7\text{ to }5.5\text{ V}$	2.0	-	-	V
$V_{IL}$	Low level input voltage	$V_{IN} = 4.5\text{ to }5.5\text{ V}$	-	-	0.8	V
		$V_{IN} = 2.7\text{ to }4.5\text{ V}$	-	-	0.4	V
$I_{IN}$	Input current	$V_{IEN} = 0\text{ V or }V_{IN}$	-0.5	-	0.5	μA



**Table 16. EN pin characteristics**  
( $V_{IN} = 5.5\text{ V}$ ,  $I_{OUT} = \text{rated current}$ ,  $T_J = 25\text{ }^\circ\text{C}$ , unless otherwise specified)

$t_{ON}$	Turn-ON time <sup>(1)</sup>	$R_L = 10\ \Omega$ $C_L = 100\ \mu\text{F}$	-	-	5	ms
$t_{OFF}$	Turn-OFF time <sup>(1)</sup>	$R_L = 10\ \Omega$ $C_L = 100\ \mu\text{F}$	-	-	10	ms

1. Not tested in production, specified by design.



## 7 Detail device characteristics

### 7.1 STMP2141, STMP2151 additional electrical charts

The waveforms displayed in [Section 7.1](#) are captured with the STMP2141 device. The STMP2151 device is expected to have the same characteristics with EN in the opposite polarity.

#### 7.1.1 Turn-on/off characteristics at $V_{OUT} = 5.0\text{ V}$

Figure 3. Voltage output turn-on delay time (STMP2141/2151, 5 V)

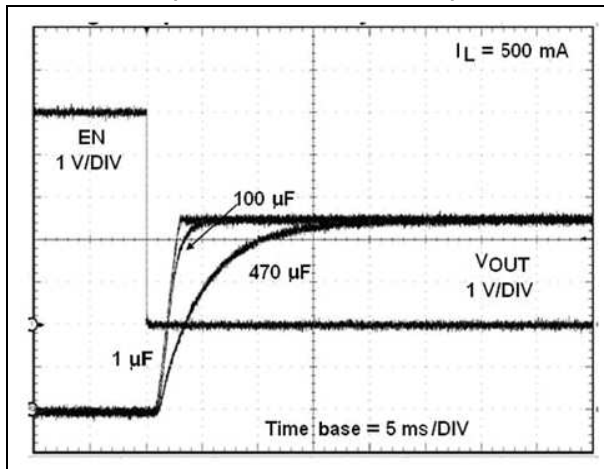

Figure 4. Voltage output turn-off delay time (STMP2141/2151, 5 V)

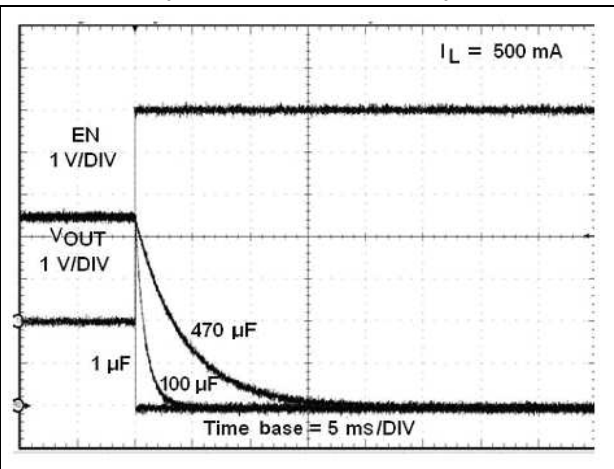

Figure 5. Current output turn-on delay time (STMP2141/2151, 5 V)

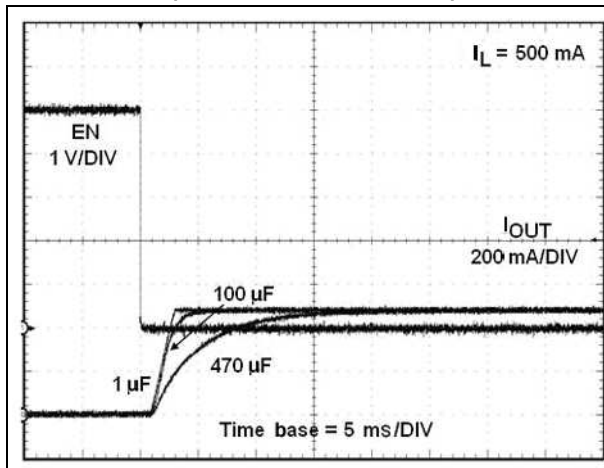
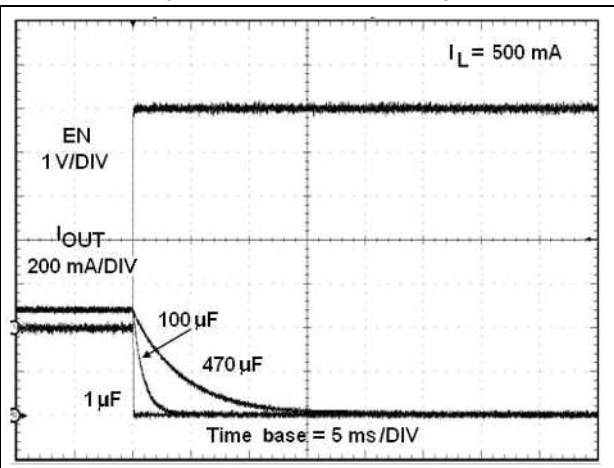

Figure 6. Current output turn-off delay time (STMP2141/2151, 5 V)



7.1.2 Turn-on/off characteristics at  $V_{OUT} = 3.0\text{ V}$

Figure 7. Voltage output turn-on delay time (STMPS2141/2151, 3 V)

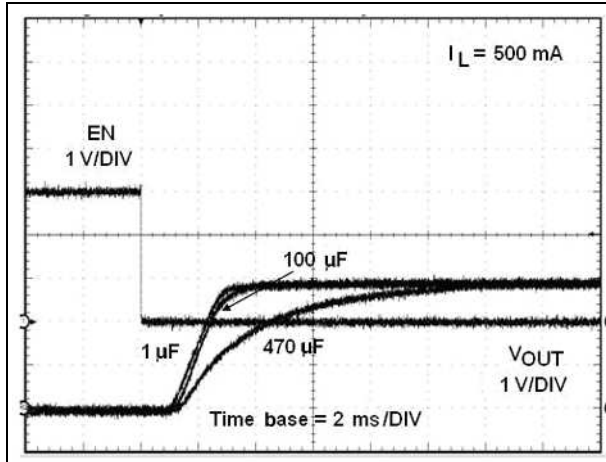

Figure 8. Voltage output turn-off delay time (STMPS2141/2151, 3 V)

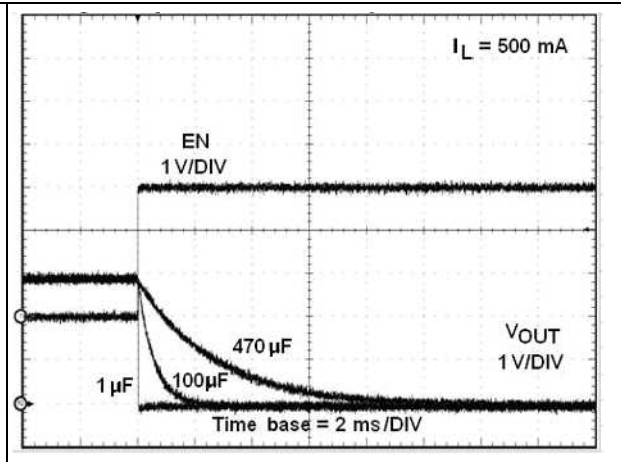

Figure 9. Current output turn-on delay time (STMPS2141/2151, 3 V)

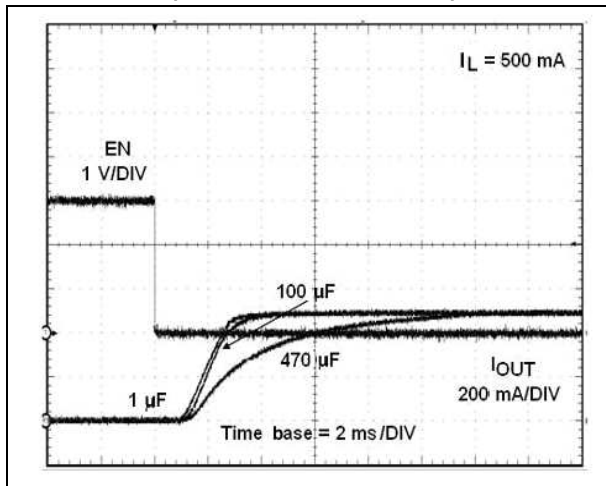
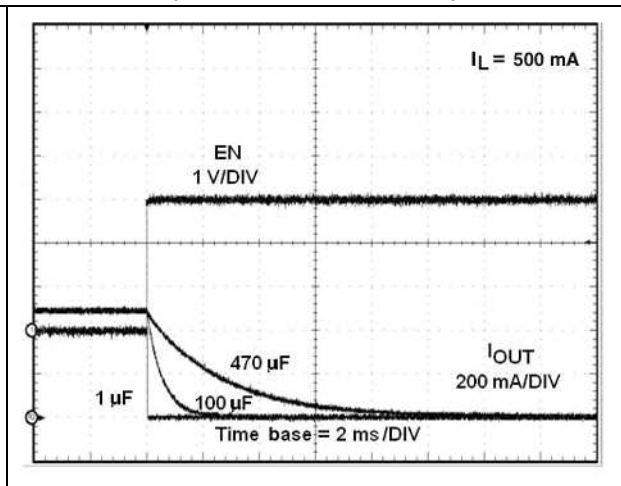

Figure 10. Current output turn-off delay time (STMPS2141/2151, 3 V)



### 7.1.3 UVLO

Figure 11. UVLO rising (STMP2141/2151)

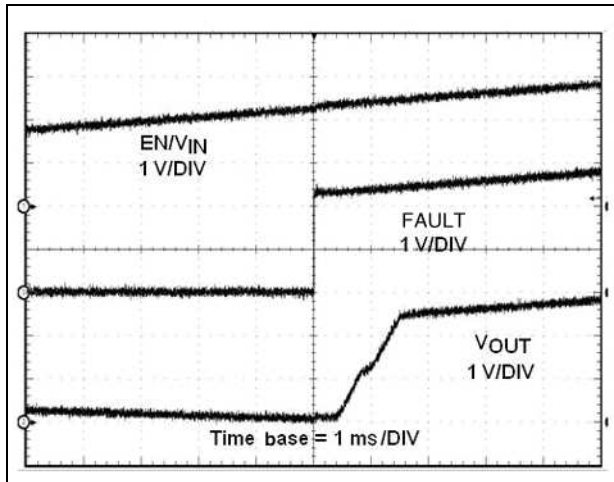
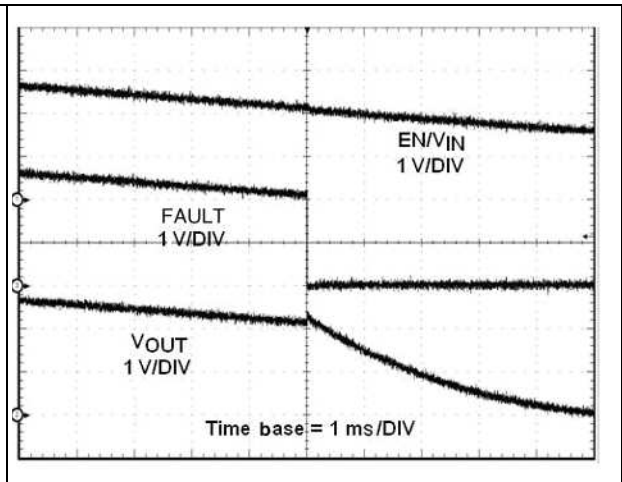

Figure 12. UVLO falling (STMP2141/2151)



### 7.1.4 OC protection characteristics

Figure 13. OC protection at  $V_{OUT} = 3.0\text{ V}$  (STMP2141/2151)

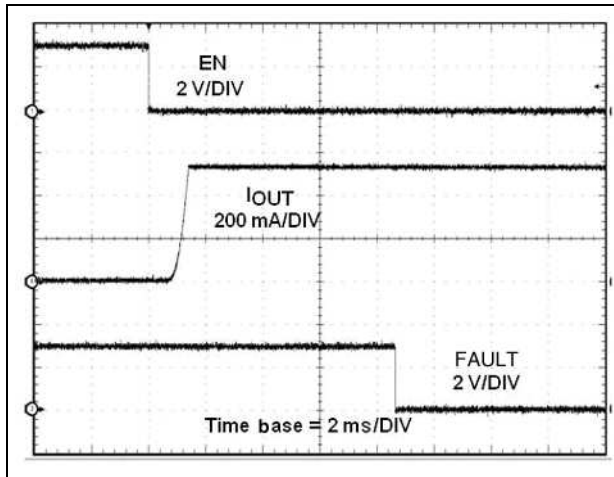

Figure 14. OC protection at  $V_{OUT} = 3.0\text{ V}$  (STMP2141/2151 - details)

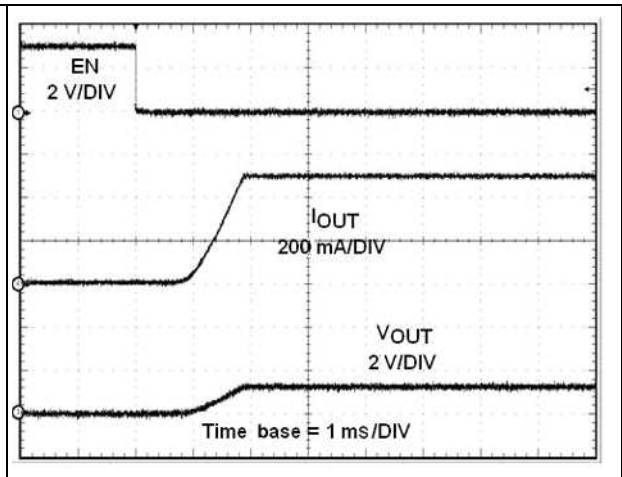

Figure 15. OC protection at  $V_{OUT} = 5.0\text{ V}$  (STMPS2141/2151)

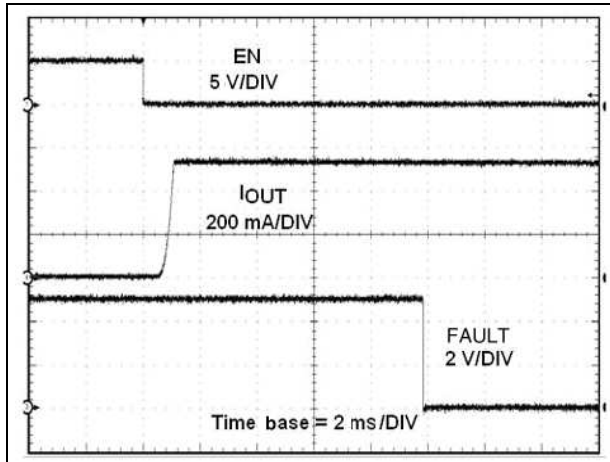
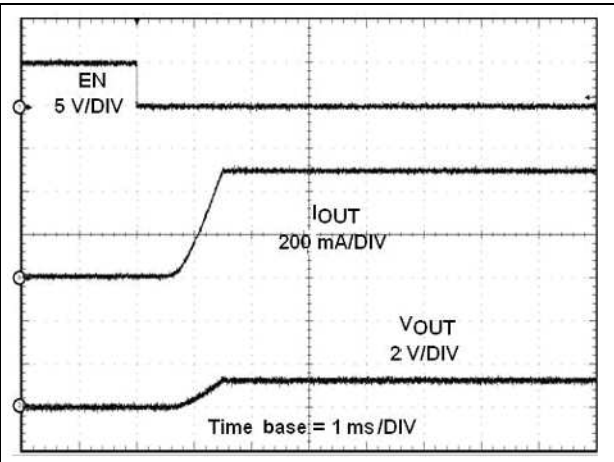

Figure 16. OC protection at  $V_{OUT} = 5.0\text{ V}$  (STMPS2141/2151 - details)



### 7.1.5 Other electrical characteristics

Figure 17.  $I_{CC}$  vs.  $V_{IN}$  (enabled) (STMPS2141/2151)

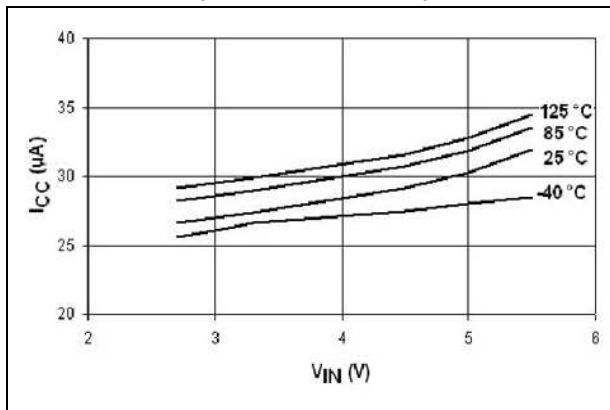

Figure 18.  $I_{CC}$  vs. temperature (enabled) (STMPS2141/2151)

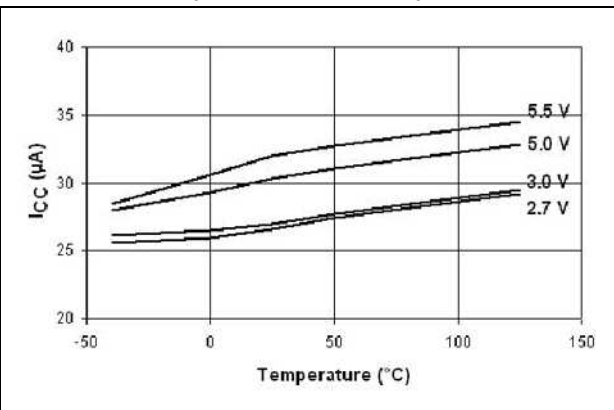

Figure 19.  $I_{CC}$  vs.  $V_{IN}$  (disabled) (STMPS2141/2151)

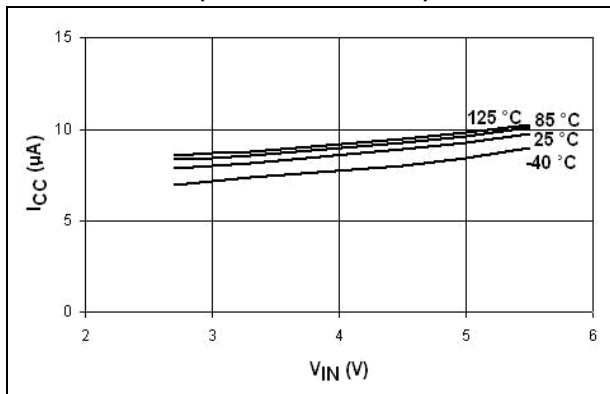

Figure 20.  $I_{CC}$  vs. temperature (disabled) (STMPS2141/2151)

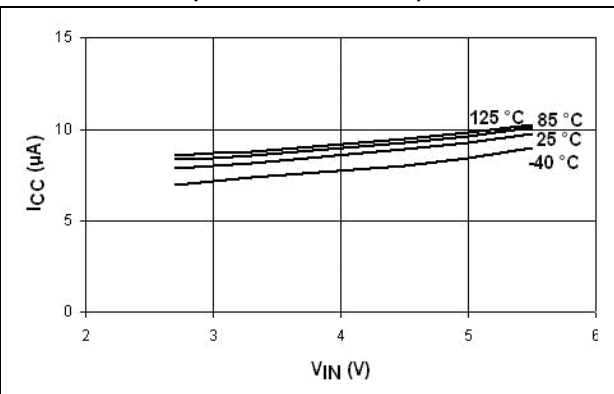

Figure 21.  $R_{ON}$  vs.  $V_{IN}$  (STMP2141/2151)

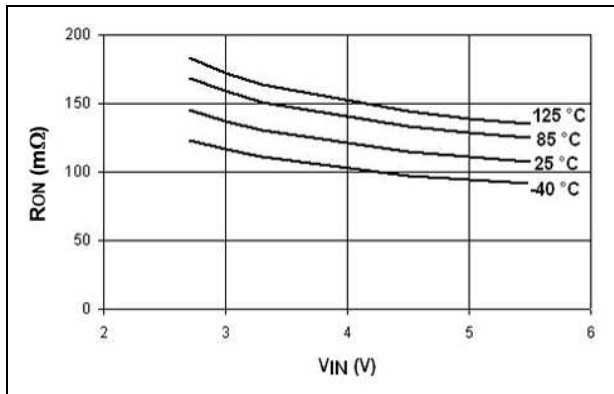

Figure 22.  $R_{ON}$  vs. temperature (STMP2141/2151)

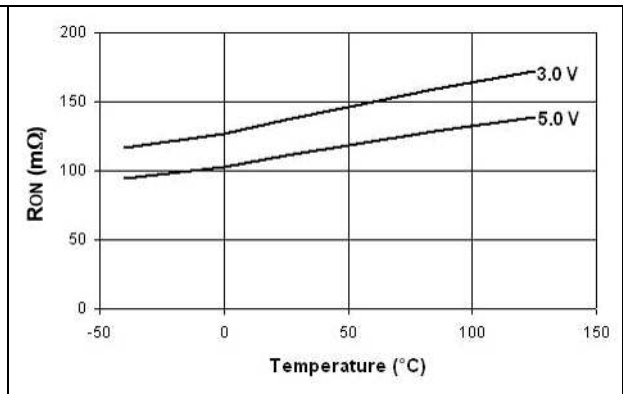

Figure 23.  $I_{OS}$  vs. temperature (STMP2141/2151)

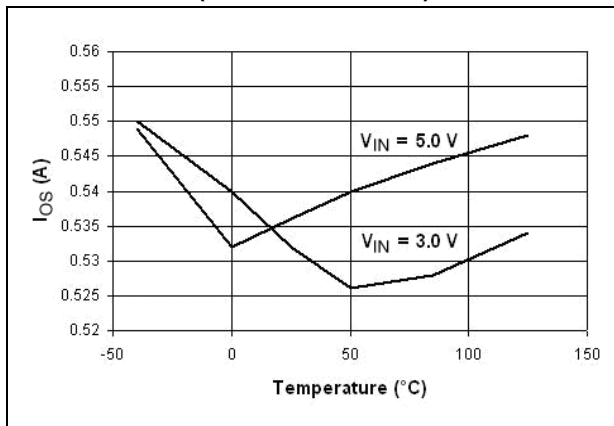

Figure 24. Switch leakage vs. temperature (STMP2141/2151)

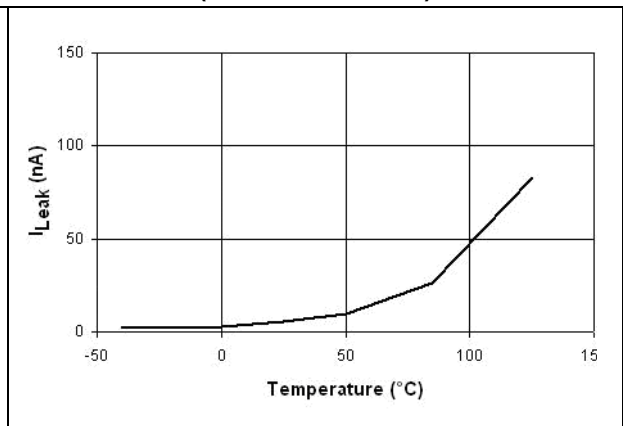

Figure 25. Output rise time vs.  $V_{IN}$  (STMP2141/2151)

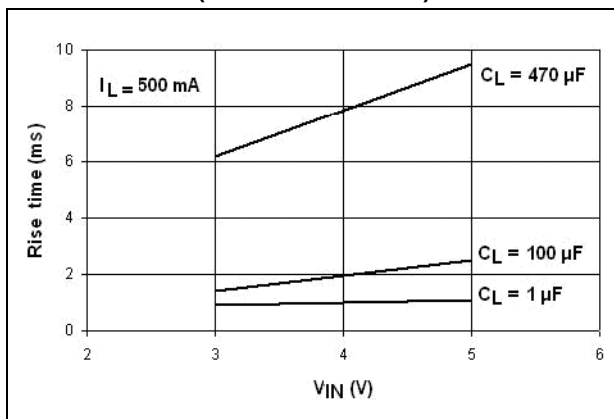

Figure 26. Output fall time vs.  $V_{IN}$  (STMP2141/2151)

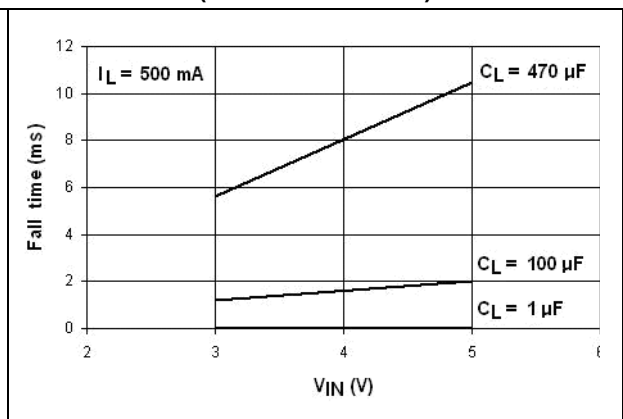
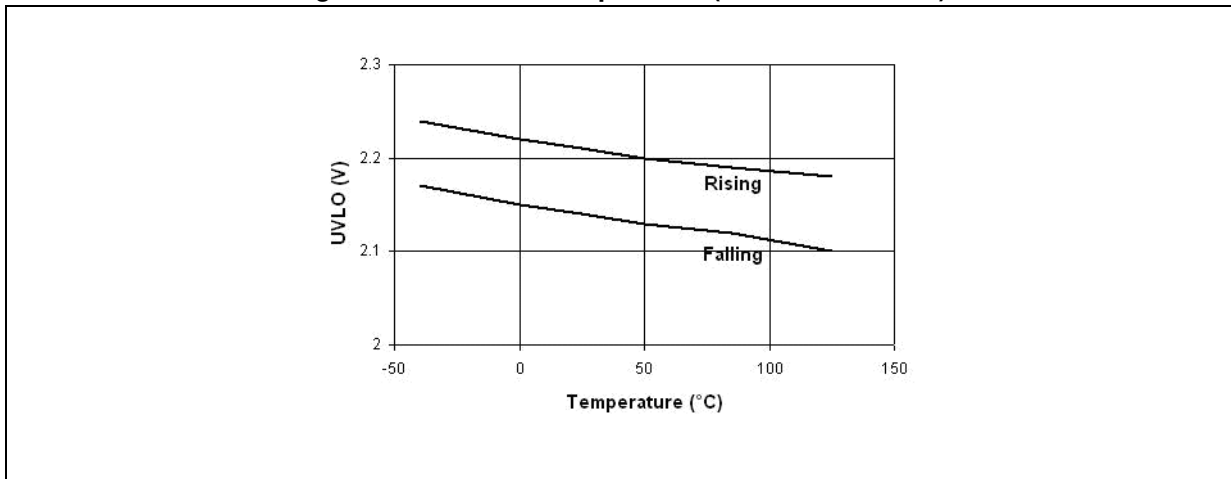

Figure 27. UVLO vs. temperature (STMPS2141/2151)



## 7.2 STMP2161, STMP2171 electrical charts

The waveforms displayed in [Section 7.2](#) are captured with the STMP2161 device. The STMP2171 device is expected to have the same characteristics with EN in the opposite polarity.

### 7.2.1 Turn-on/off characteristics at $V_{OUT} = 5.0\text{ V}$

Figure 28. Voltage output turn-on delay time (STMP2161/2171, 5 V)

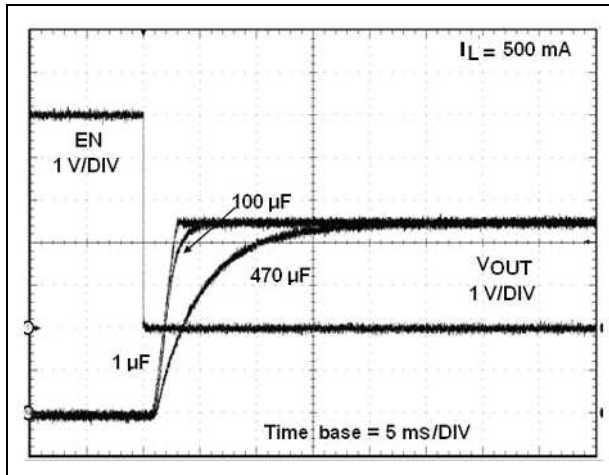

Figure 29. Voltage output turn-off delay time (STMP2161/2171, 5 V)

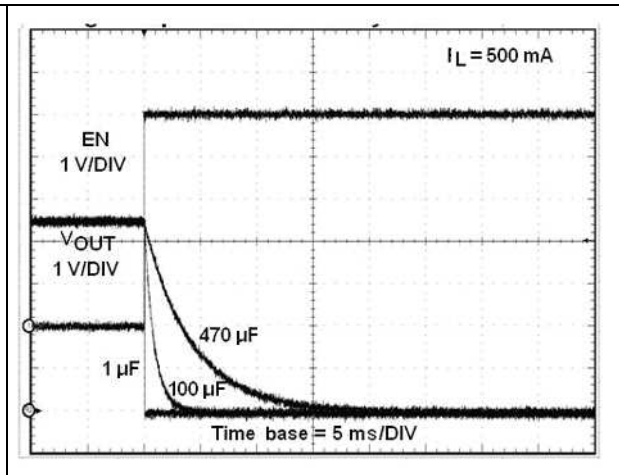

Figure 30. Current output turn-on delay time (STMP2161/2171, 5 V)

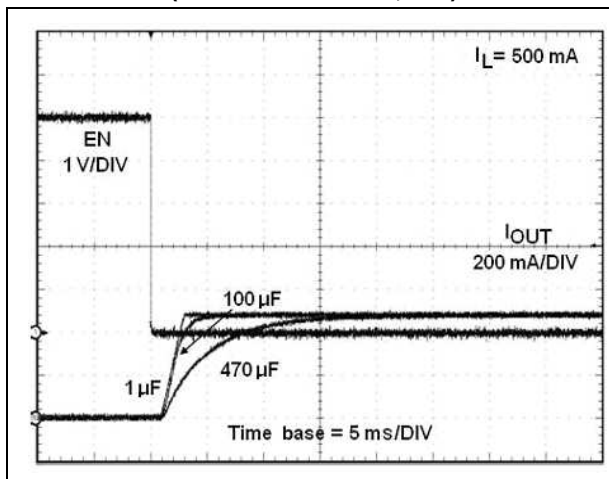
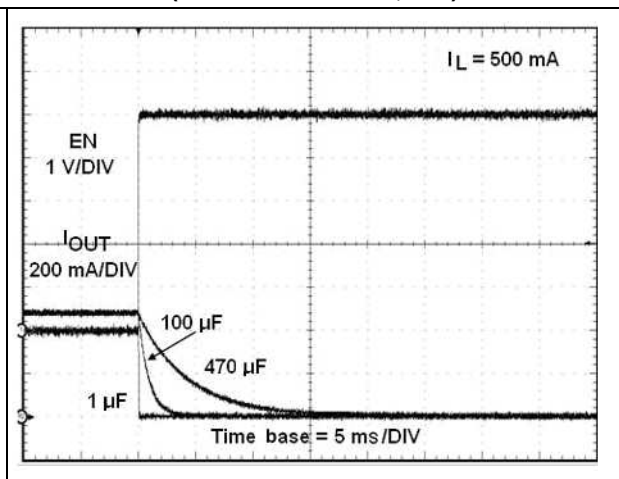

Figure 31. Current output turn-off delay time (STMP2161/2171, 5 V)



### 7.2.2 Turn-on/off characteristics at $V_{OUT} = 3.0\text{ V}$

Figure 32. Voltage output turn-on delay time (STMPS2161/2171, 3 V)

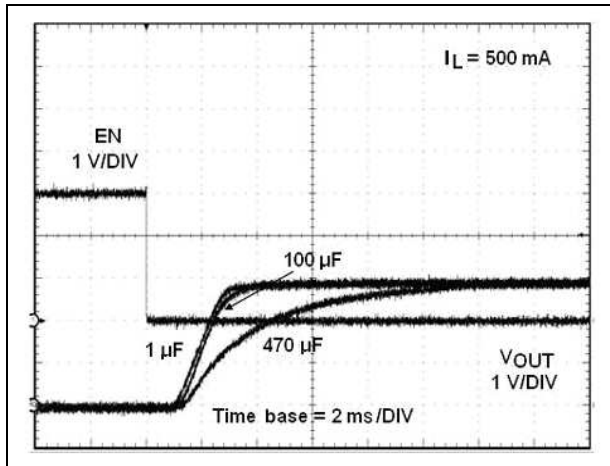

Figure 33. Voltage output turn-off delay time (STMPS2161/2171, 3 V)

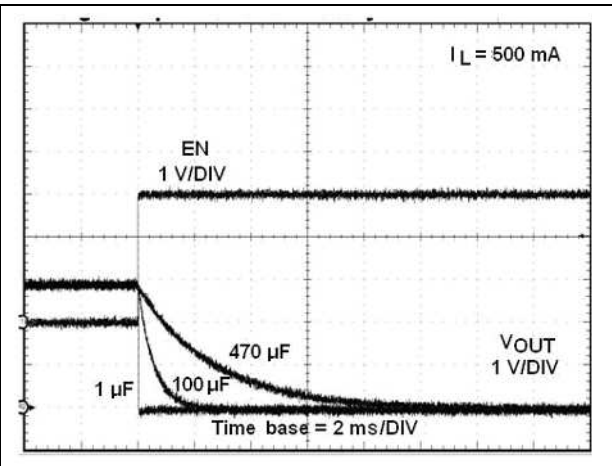

Figure 34. Current output turn-on delay time (STMPS2161/2171, 3 V)

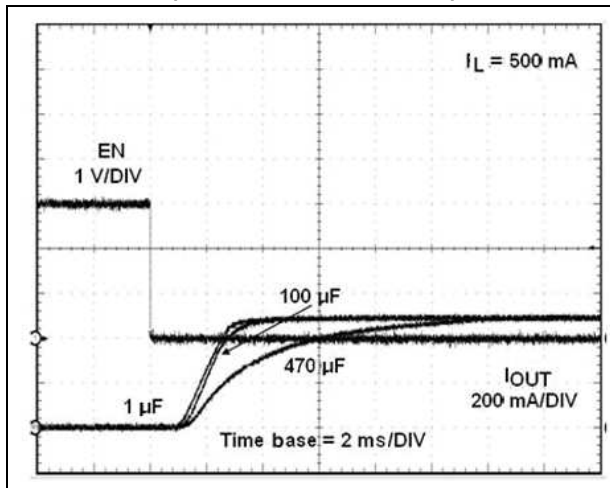
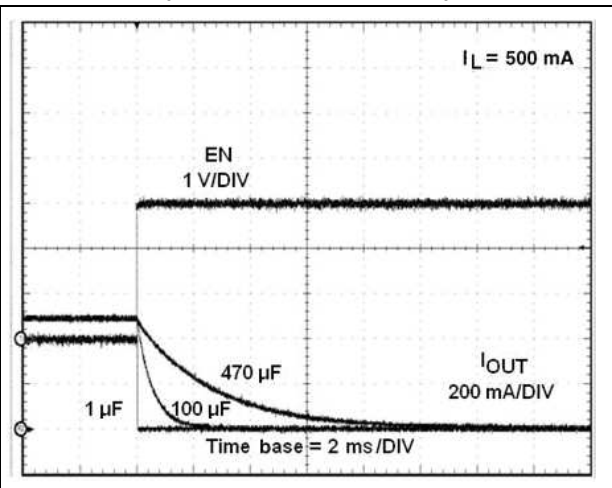

Figure 35. Current output turn-off delay time (STMPS2161/2171, 3 V)





### 7.2.3 UVLO

Figure 36. UVLO rising (STMP2161/2171)

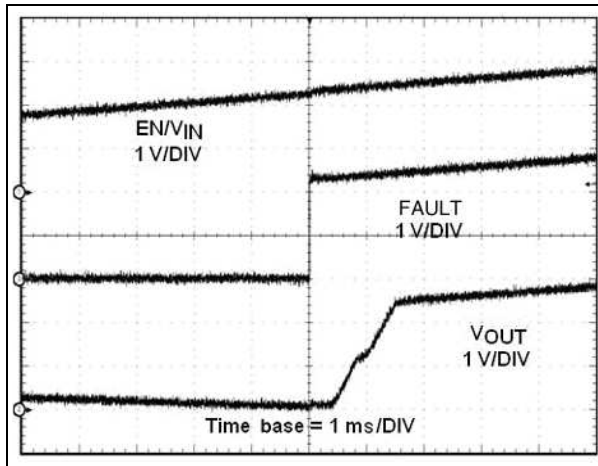
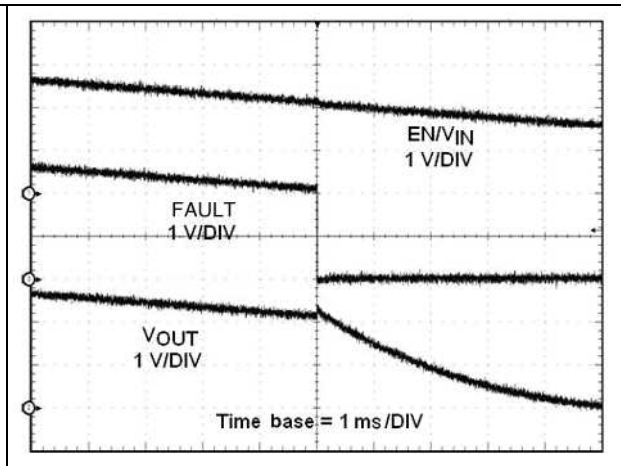

Figure 37. UVLO falling (STMP2161/2171)



### 7.2.4 OC protection characteristics

Figure 38. OC protection at  $V_{OUT} = 3.0\text{ V}$  (STMP2161/2171)

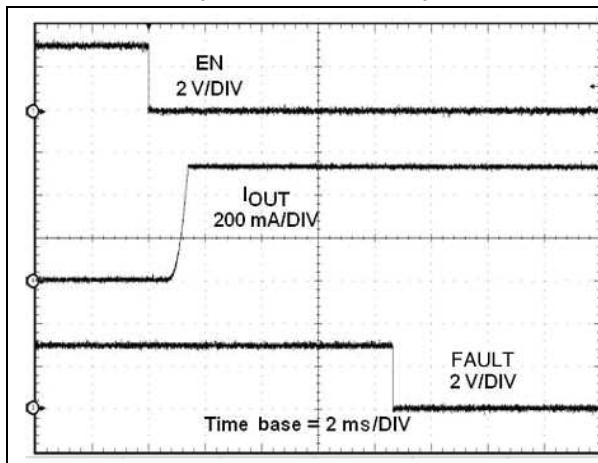

Figure 39. OC protection at  $V_{OUT} = 3.0\text{ V}$  (STMP2161/2171- detail)

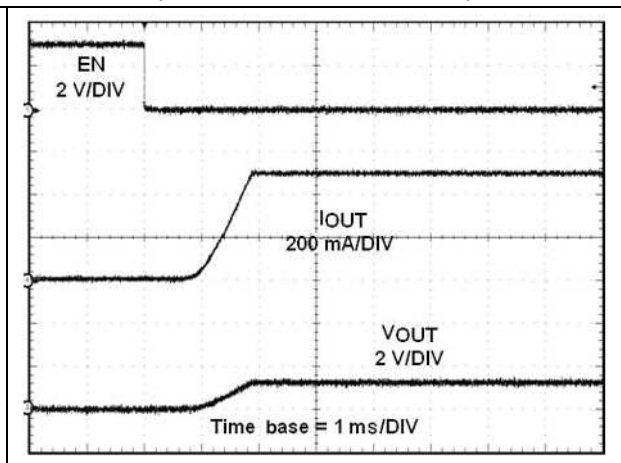

Figure 40. OC protection at  $V_{OUT} = 5.0\text{ V}$  (STMP2161/2171)

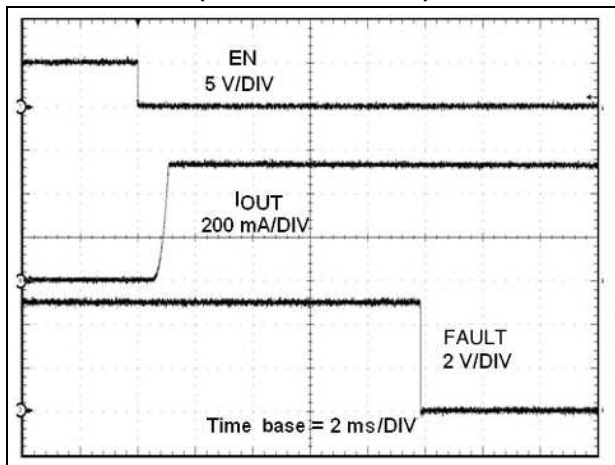
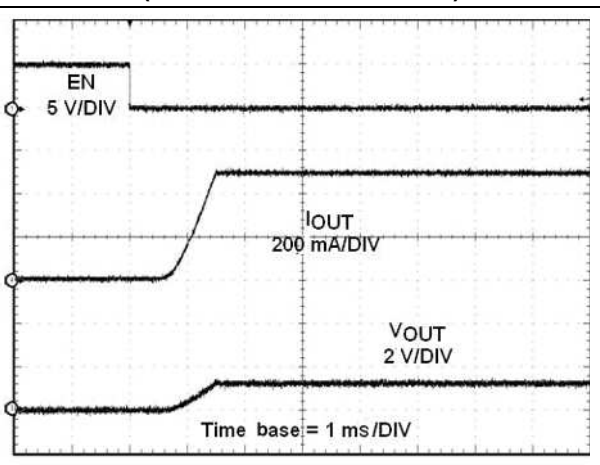

Figure 41. OC protection at  $V_{OUT} = 5.0\text{ V}$  (STMP2161/2171- detail)



7.2.5 Other electrical characteristics

Figure 42.  $I_{CC}$  vs.  $V_{IN}$  (enabled) (STMP2161/2171)

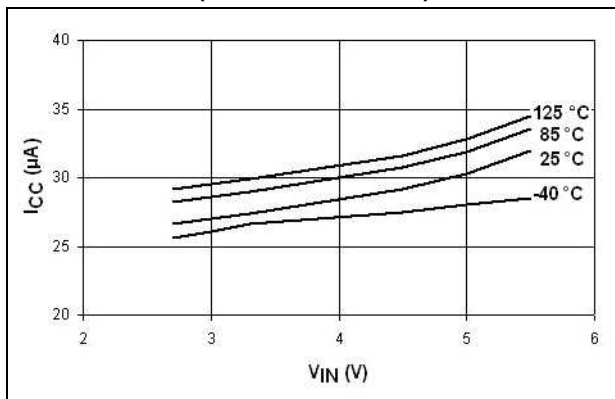

Figure 43.  $I_{CC}$  vs. temperature (enabled) (STMP2161/2171)

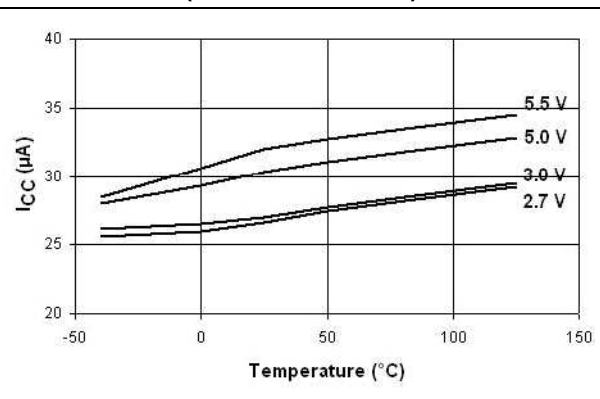

Figure 44.  $I_{CC}$  vs.  $V_{IN}$  (disabled) (STMP2161/2171)

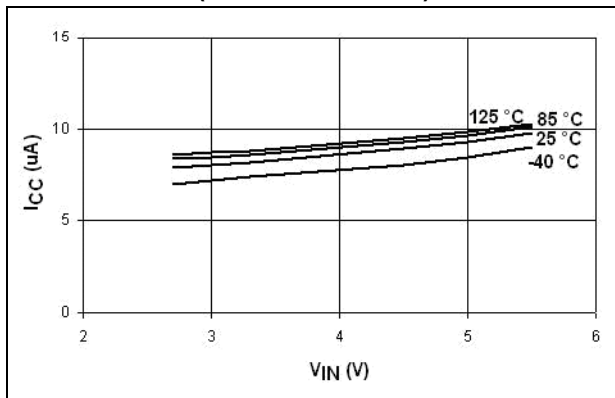

Figure 45.  $I_{CC}$  vs. temperature (disabled) (STMP2161/2171)

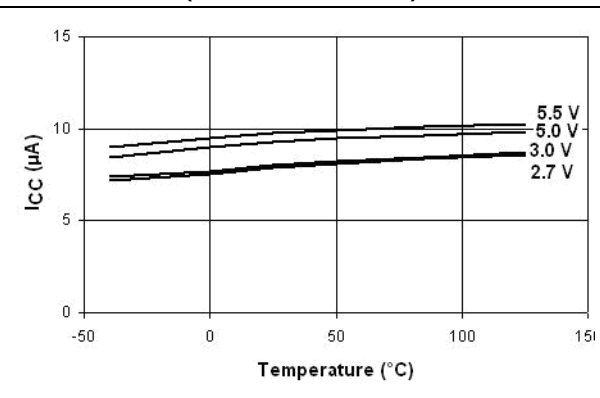

Figure 46.  $R_{ON}$  vs.  $V_{IN}$  (STMP2161/2171)

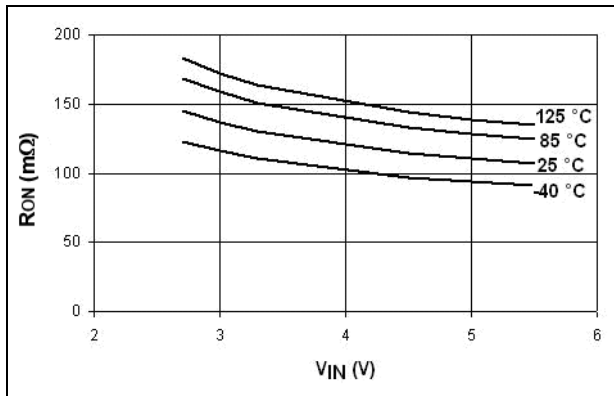

Figure 47.  $R_{ON}$  vs. temperature (STMP2161/2171)

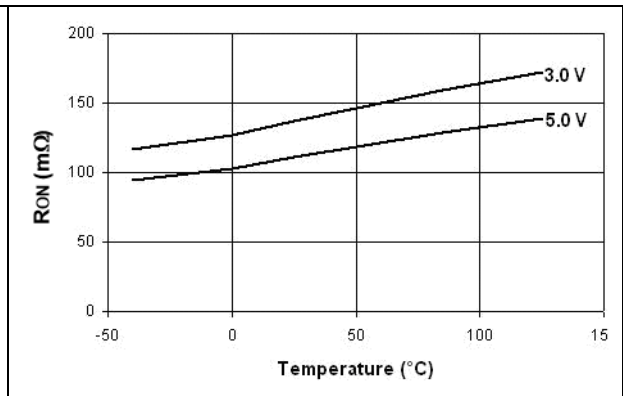

Figure 48.  $I_{OS}$  vs. temperature (STMP2161/2171)

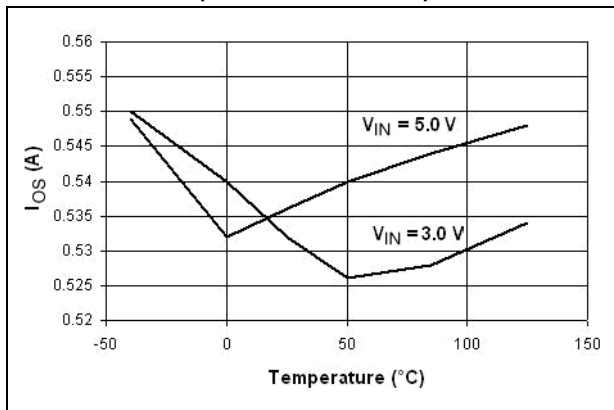

Figure 49. Switch leakage vs. temperature (STMP2161/2171)

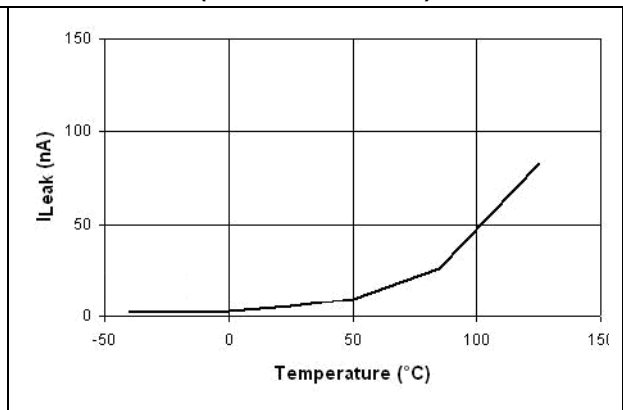

Figure 50. Output rise time vs.  $V_{IN}$  (STMP2161/2171)

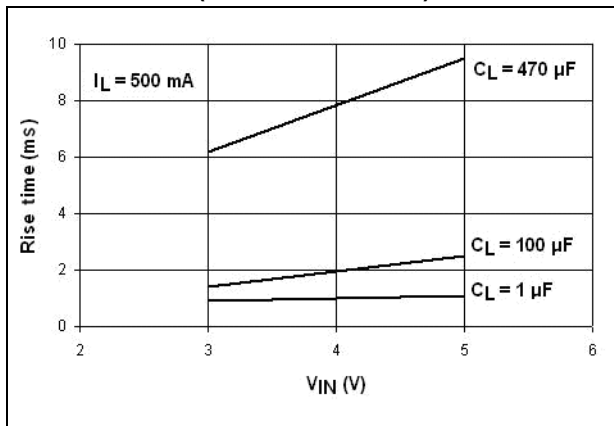

Figure 51. Output fall time vs.  $V_{IN}$  (STMP2161/2171)

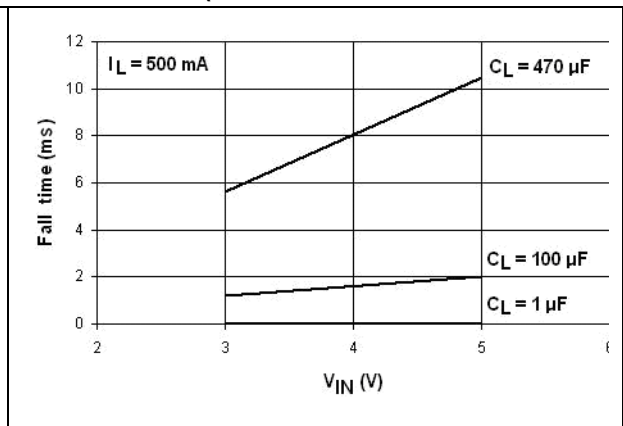
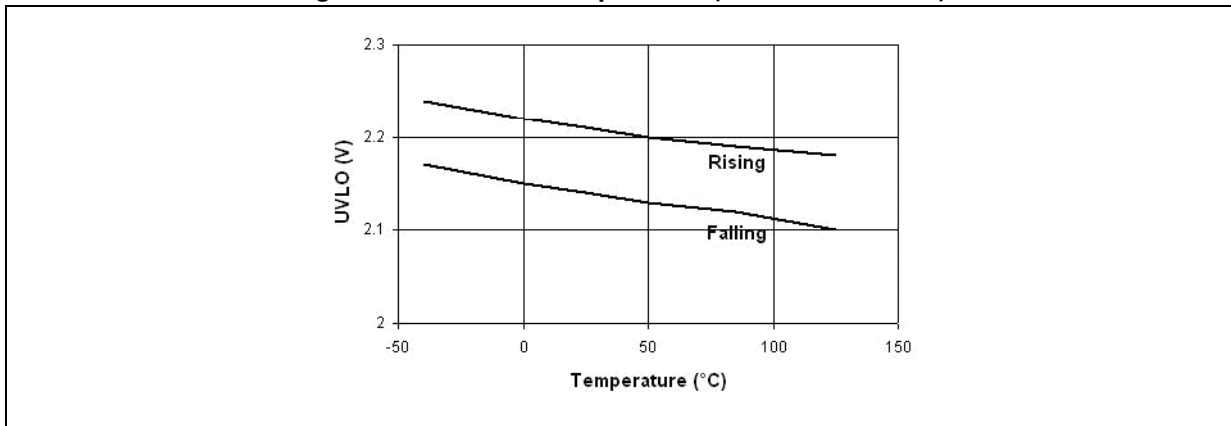

Figure 52. UVLO vs. temperature (STMPS2161/2171)



## 8 Package mechanical data

In order to meet environmental requirements, ST offers these devices in different grades of ECOPACK® packages, depending on their level of environmental compliance. ECOPACK specifications, grade definitions and product status are available at: [www.st.com](http://www.st.com). ECOPACK is an ST trademark.

Figure 53. SOT23-5L package outline

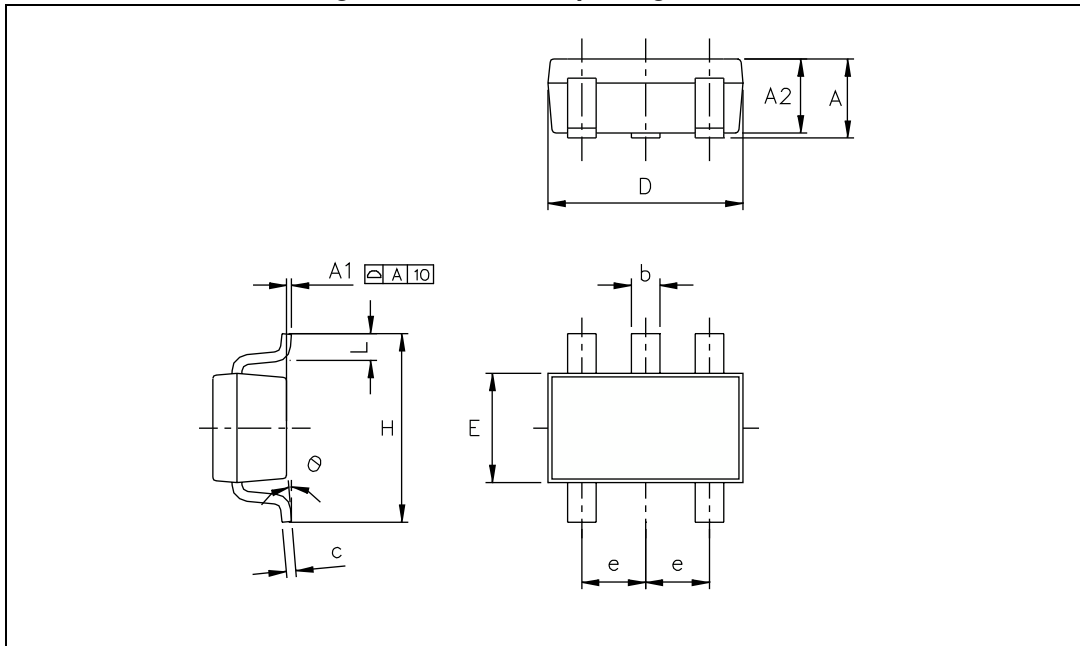

Table 17. SOT23-5L package mechanical data

Symbol	Dimensions					
	Millimeters			Inches		
	Min.	Typ.	Max.	Min.	Typ.	Max.
A	0.90	-	1.45	35.4	-	57.1
A1	0.00	-	0.10	0.0	-	3.9
A2	0.90	-	1.30	35.4	-	51.2
b	0.35	-	0.50	13.7	-	19.7
C	0.09	-	0.20	3.5	-	7.8
D	2.80	-	3.00	110.2	-	118.1
E	1.50	-	1.75	59.0	-	68.8
e	-	0.95	-	-	37.4	-
H	2.60	-	3.00	102.3	-	118.1
L	0.10	-	0.60	3.9	-	23.6

Figure 54. SOT23-5L footprint recommendations

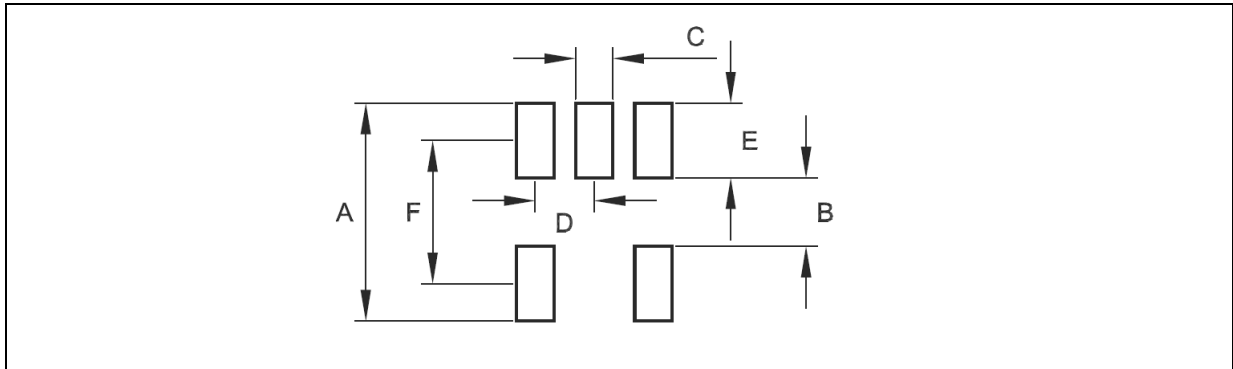
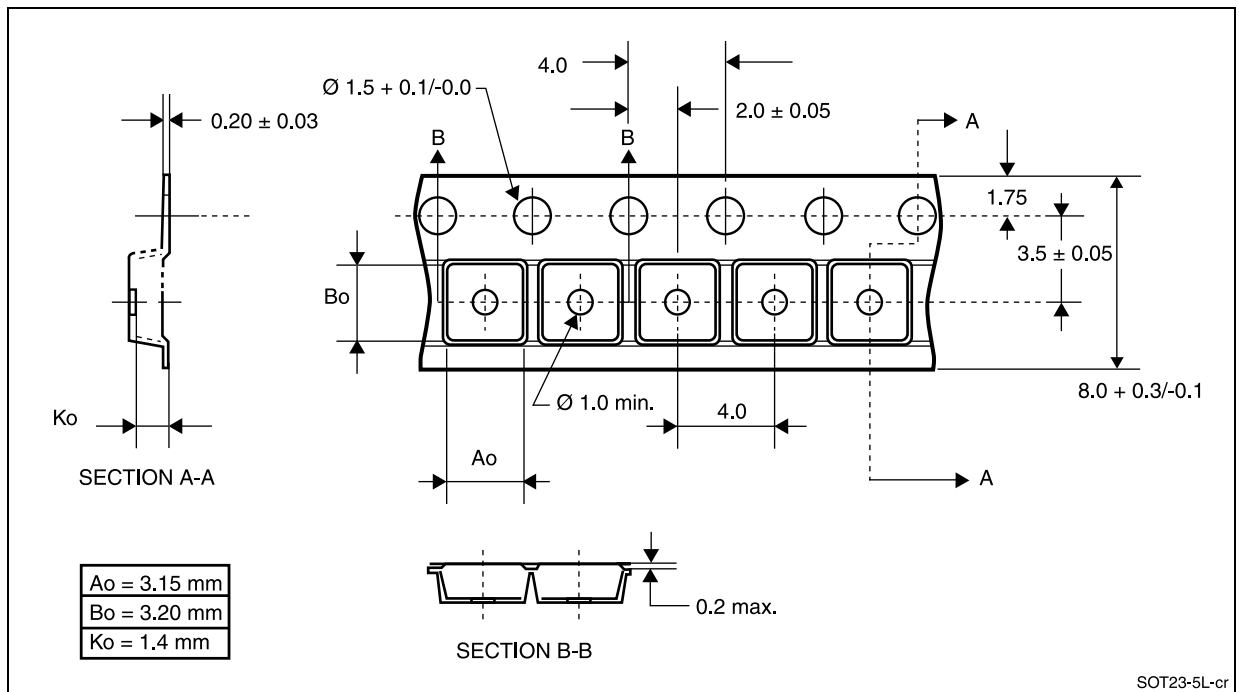

Table 18. SOT23-5L footprint dimensions

Footprint data		
Symbol	Dimensions	
	Millimeters	Inches
A	3.50	0.138
B	1.10	0.043
C	0.60	0.024
D	0.95	0.037
E	1.20	0.047
F	2.30	0.090

Figure 55. SOT23-5L carrier tape



SOT23-5L-cr

Figure 56. SO-8 package outline

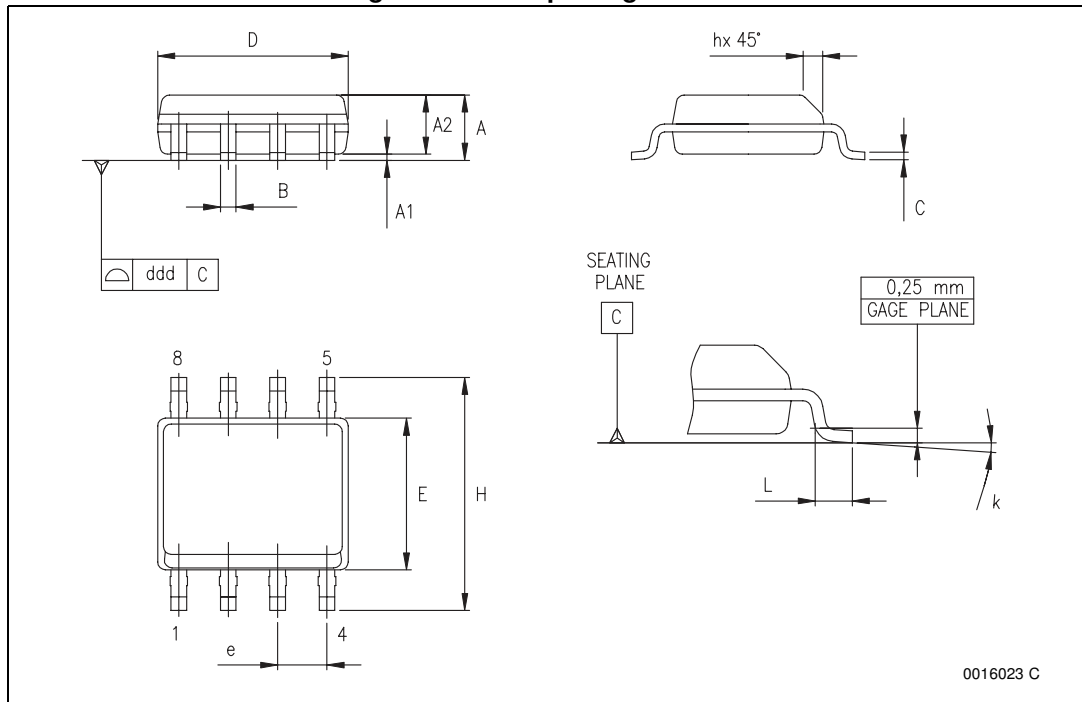

1. Drawing is not to scale.

Table 19. SO-8 mechanical data

Symbol	Dimensions					
	Millimeters			Inches		
	Min.	Typ.	Max.	Min.	Typ.	Max.
A	1.35	-	1.75	0.053	-	0.069
A1	0.10	-	0.25	0.004	-	0.010
A2	1.10	-	1.65	0.043	-	0.065
B	0.33	-	0.51	0.013	-	0.020
C	0.19	-	0.25	0.007	-	0.010
D <sup>(1)</sup>	4.80	-	5.00	0.189	-	0.197
E	3.80	-	4.00	0.15	-	0.157
e	-	1.27	-	-	0.050	-
H	5.80	-	6.20	0.228	-	0.244
h	0.25	-	0.50	0.010	-	0.020
L	0.40	-	1.27	0.016	-	0.050
k	0° (min.), 8° (max.)					
ddd	-	-	0.10	-	-	0.004

1. Dimension D does not include mold flash, protrusions or gate burrs. Mold flash, protrusions or gate burrs shall not exceed 0.15 mm (0.006 inch) in total (both sides).



Figure 57. SO-8 carrier tape

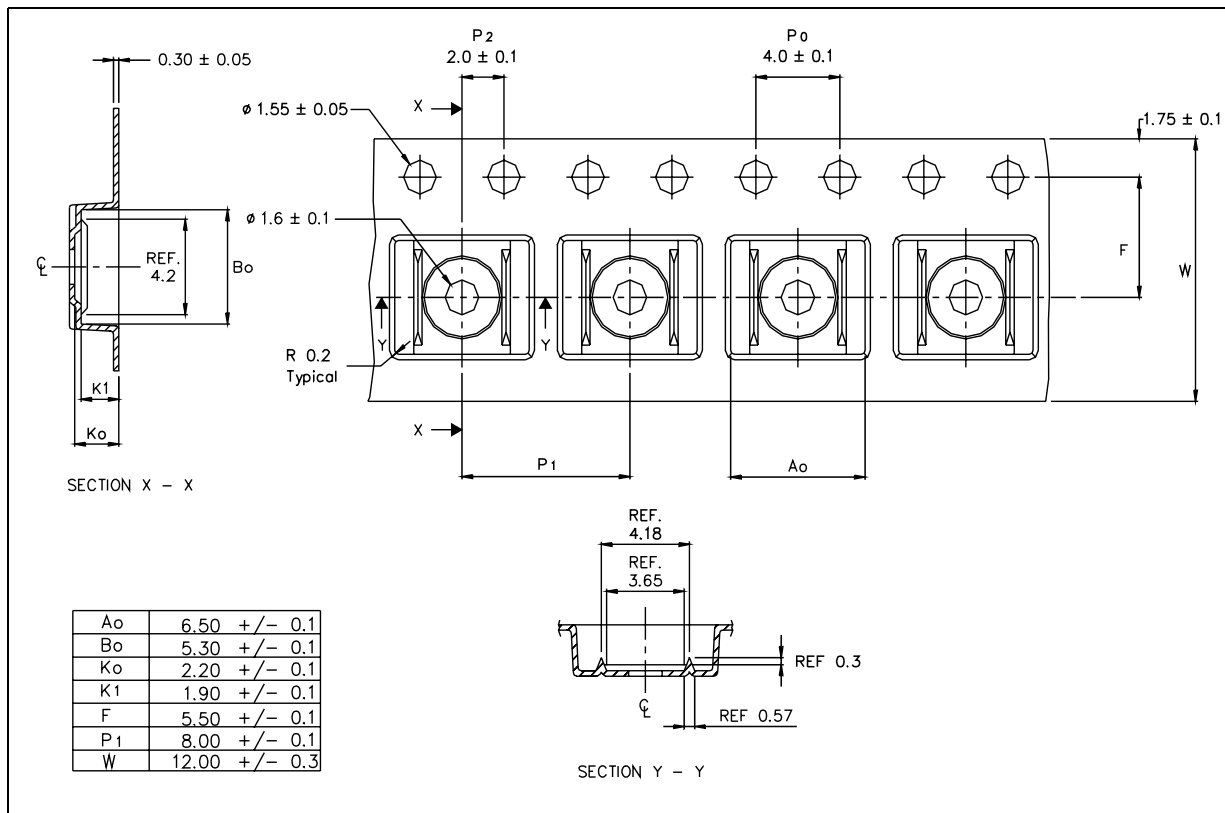
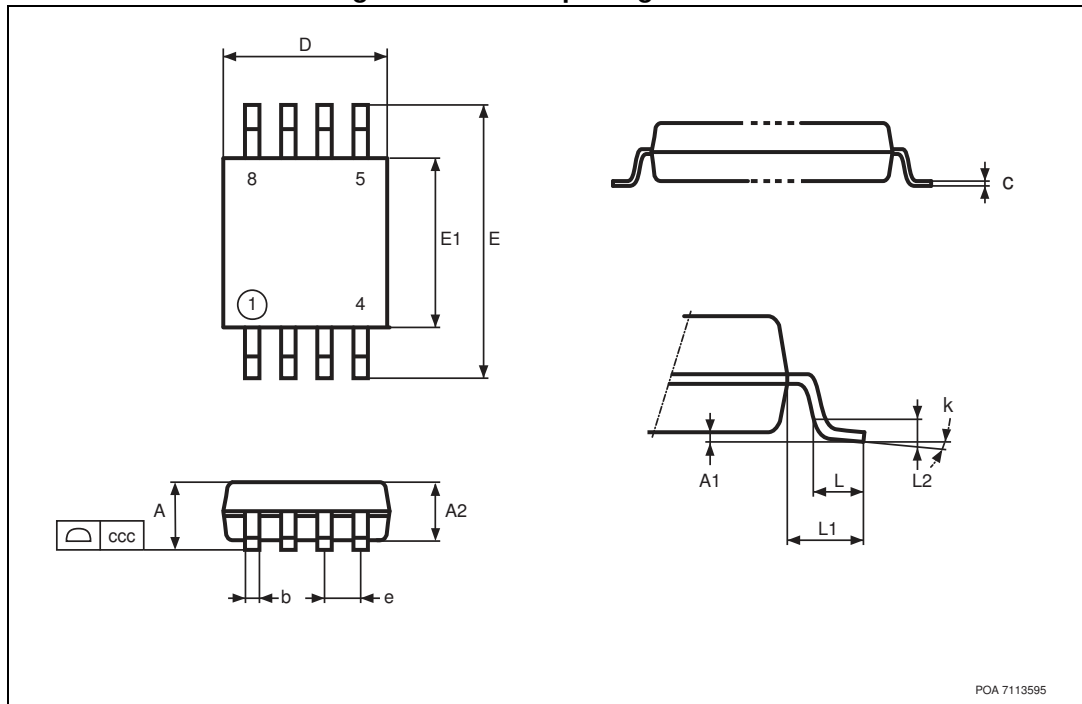

Figure 58. MSOP8 package outline



1. Drawing not to scale.

Table 20. MSOP8 package mechanical data

Symbol	Dimensions					
	Millimeters			Inches		
	Min.	Typ.	Max.	Min.	Typ.	Max.
A	-	-	1.10	-	-	0.043
A1	0.05	-	0.15	0.002	0.004	0.006
A2	0.75	0.85	0.95	0.031	0.034	0.037
b	0.25	-	0.40	0.010	0.013	0.016
c	0.13	-	0.23	0.005	0.007	0.009
D	2.90	3.00	3.10	0.114	0.118	0.122
E	4.65	4.90	5.15	0.187	0.193	0.199
E1	2.90	3.00	3.10	0.114	0.118	0.122
e	-	0.65	-	-	0.026	-
L	0.40	0.55	0.70	0.016	0.022	0.028
L1	-	0.95	-	-	0.037	-
K	0°	-	6°	0°	-	6°
ccc			0.10			0.004

Figure 59. MSOP8 carrier tape

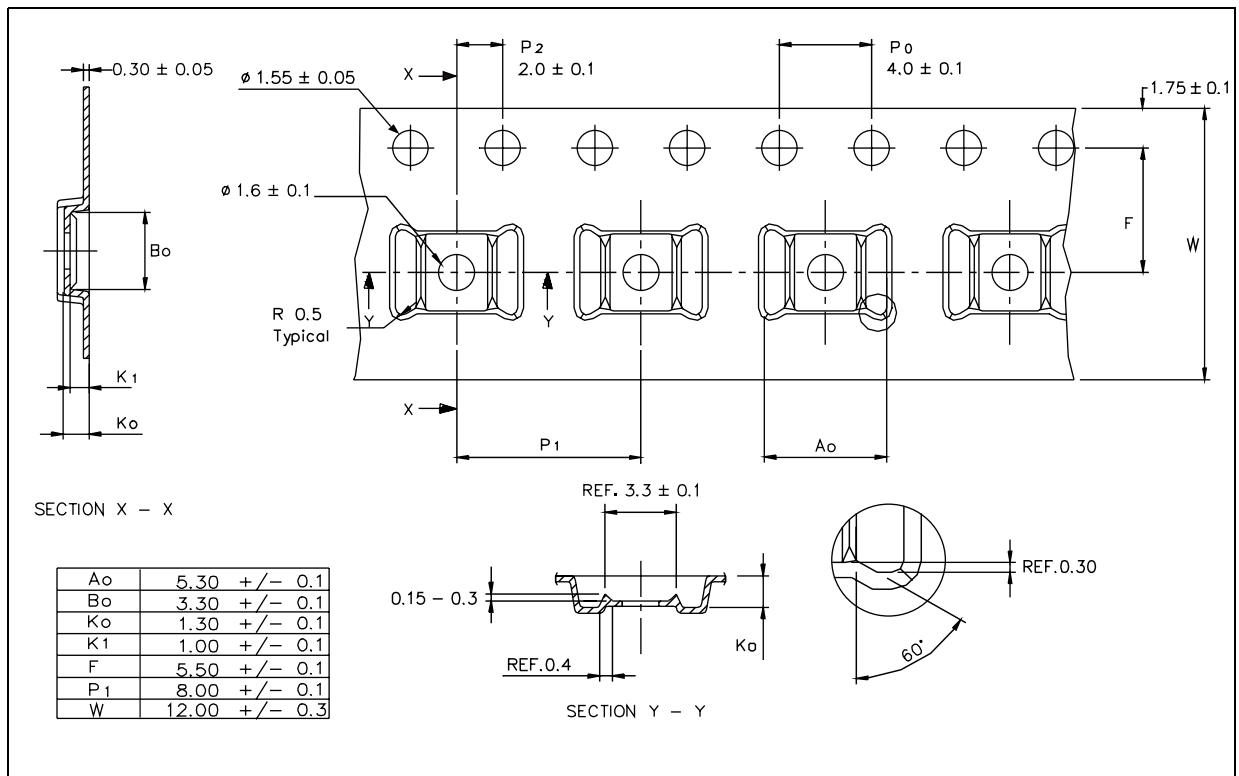

Figure 60. Reel information

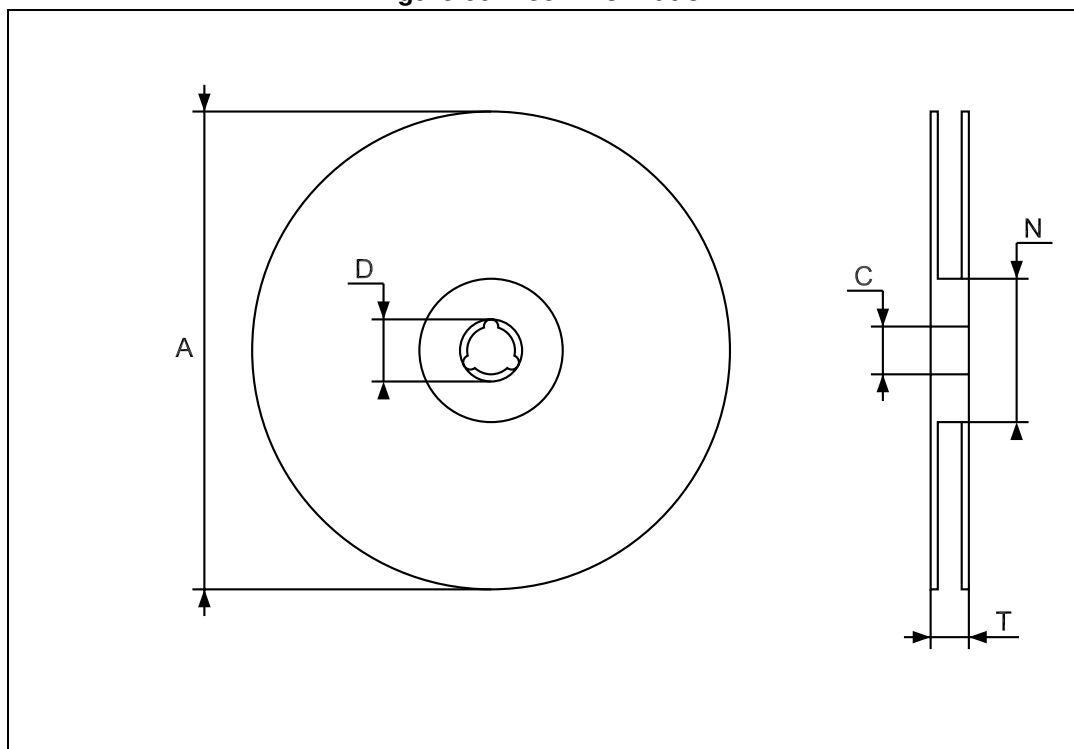

Table 21. Reel mechanical data

Symbol	Dimensions (mm)		
	Min.	Typ.	Max.
A			
SOT23-5L			180
S0-8, MSOP8	-	-	330
C	12.8	13.0	13.2
D	20.2	-	-
N	60	-	-
T	-	-	22.4

## 9 Ordering information

Table 22. Order codes

Part number	Package	Marking
STMPS2141MTR	SO-8	2141E
STMPS2151MTR		2151E
STMPS2161MTR		2161E
STMPS2171MTR		2171E
STMPS2141STR	SOT23-5L	2141
STMPS2151STR		2151
STMPS2161STR		2161
STMPS2171STR		2171
STMPS2141TTR	MSOP8	2141
STMPS2151TTR		2151
STMPS2161TTR		2161
STMPS2171TTR		2171

## 10 Revision history

**Table 23. Document revision history**

Date	Revision	Changes
01-Aug-2007	1	Initial release.
18-Dec-2007	2	Minor text changes, updated Figure 53 on page 28, added Section 7: Detail device characteristics on page 16.
24-Jan-2008	3	Footnote added in Table 1 on page 1, replaced Figure 58 on page 32 and Table 20 on page 32, TSSOP8 package name replaced with MSOP8.
17-Jul-2009	4	Updated Chapter 3, test conditions modified for Ireverse in Table 12 on page 14 and Chapter 7. Added: Figure 55, Figure 56, Figure 59, Figure 59 and Figure 60.
21-Nov-2012	5	Updated Table 1 (replaced "Current limit" by "Rated continuous output current"). Updated values and units in Table 4 to Table 6. Corrected Figure 1 and Figure 2 (replaced EN_N by EN). Replaced $I_I$ by $I_{IN}$ , $I_{LIMIT}$ by $I_{OS}$ , $I_O$ by $I_{OUT}$ , mS by ms, OC by FAULT, $R_{ds(on)}$ by $R_{ON}$ , $V_I$ and $V_{CC}$ by $V_{IN}$ , $V_O$ by $V_{OUT}$ , in the whole document. Updated Section 5 (added cross-references). Updated Table 9 and Table 10 (replaced $T_r$ by $t_r$ ), Table 11 (updated test conditions). Updated Table 15 (replaced Fault, OCx, and $V_{OC}$ by FAULT). Updated Table 16 (replaced $V_{IENX}$ by $V_{IEN}$ , mF by $\mu F$ ). Updated titles of Figure 3 to Figure 52 (added conditions). Updated Figure 3 to Figure 16, Figure 25, Figure 26, Figure 28 to Figure 41, Figure 50 and Figure 51 (replaced $R_L$ by $I_L$ , mS by ms, and $\mu F$ by $\mu F$ ). Updated Figure 55, Figure 59, and Figure 59 (removed superfluous references to notes). Reformatted Section 8 (moved Figure 57 on page 31). Removed Figure 56. Updated Table 21 (added SOT23-5L, SO-8, and MSOP package and max. value for SOT23-5L package). Added Section 9. Minor corrections throughout document.
25-Jan-2013	6	Updated Features (added UL recognized components).
14-Feb-2022	7	Updated Features on the cover page, <a href="#">Figure 21</a> , <a href="#">Figure 22</a> , <a href="#">Figure 46</a> and <a href="#">Figure 47</a> .

**IMPORTANT NOTICE – PLEASE READ CAREFULLY**

STMicroelectronics NV and its subsidiaries (“ST”) reserve the right to make changes, corrections, enhancements, modifications, and improvements to ST products and/or to this document at any time without notice. Purchasers should obtain the latest relevant information on ST products before placing orders. ST products are sold pursuant to ST’s terms and conditions of sale in place at the time of order acknowledgement.

Purchasers are solely responsible for the choice, selection, and use of ST products and ST assumes no liability for application assistance or the design of Purchasers’ products.

No license, express or implied, to any intellectual property right is granted by ST herein.

Resale of ST products with provisions different from the information set forth herein shall void any warranty granted by ST for such product.

ST and the ST logo are trademarks of ST. For additional information about ST trademarks, please refer to [www.st.com/trademarks](http://www.st.com/trademarks). All other product or service names are the property of their respective owners.

Information in this document supersedes and replaces information previously supplied in any prior versions of this document.

© 2022 STMicroelectronics – All rights reserved



单击下面可查看定价，库存，交付和生命周期等信息

[>>STMicro\(意法半导体\)](#)