

2 A high PSRR ultra low drop linear regulator with reverse current protection

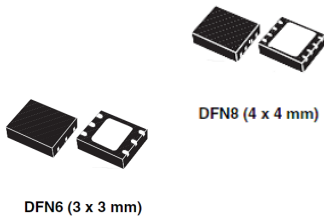

Features

- Input voltage from 1.25 V to 6.0 V
- Ultra low drop: 130 mV (typ.) at 2 A load
- 1 % output accuracy at 25 °C, 2 % in full temperature range
- High PSRR: 70 dB at 1 kHz
- Reverse current protection
- 2 A guaranteed output current
- Available in fixed and adjustable output voltage version from 0.5 V with 100 mV step
- Power Good
- Internal current and thermal limit
- Operating junction temperature range: -40 °C to 125 °C
- DFN6 (3 x 3 mm) and DFN8 (4 x 4 mm) packages

Applications

- Telecom infrastructure
- Medium power POL

Description

The **LD39200** provides 2 A of maximum current with an input voltage range from 1.25 V to 6.0 V, and a typical dropout voltage of 130 mV.

It is stable with ceramic capacitors on the output (10 µF).

Typical power supply rejection ratio is 70 dB at 1 kHz and starts to roll off at 20 kHz.

The enable logic control function puts the **LD39200** in shutdown mode, reducing the total current consumption to 10 nA (typ.).

Power Good flag is available on a dedicated pin.

The device also includes reverse current protection, short-circuit constant current limit and thermal protection.

Typical applications are for Telecom infrastructure and consumer.

Maturity status link

[LD39200](#)

1 Block diagram

Figure 1. Block diagram

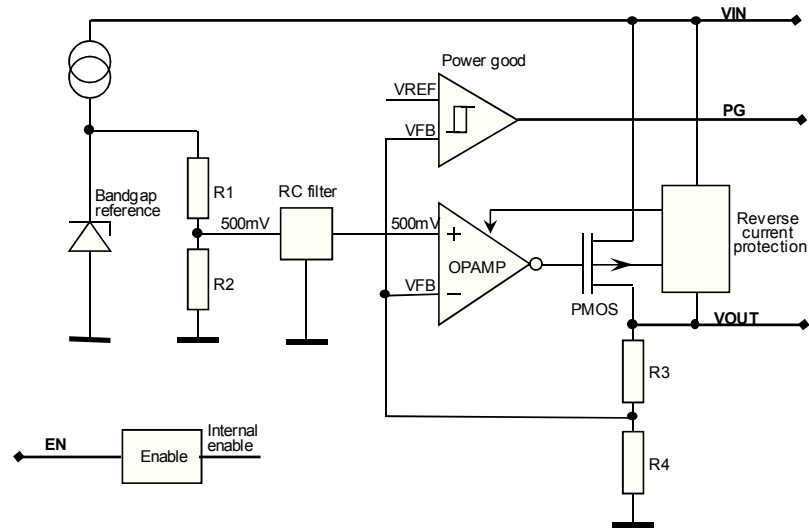

AM13907V1

2 Pin configuration and description

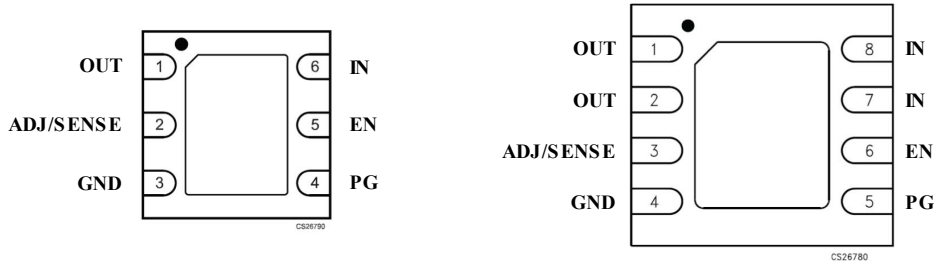
Figure 2. Pin configuration (top view)

AM13909V1

Table 1. DFN6 (3 x 3 mm) package pin description

Pin name	Pin number	Description
IN	6	Input voltage
GND	3	Ground
EN	5	Enable pin. The device is in OFF state when this pin is pulled low
ADJ/sense ⁽¹⁾	2	Adjustable pin on ADJ version can be connected to external resistor divider to set the output voltage. Output sense pin on the fixed version has to be connected to V_{OUT}
OUT	1	Output voltage
PG	4	Power Good
GND	Exposed pad	Exposed pad should be connected to GND

1. The output sense pin of the fixed version has to be connected to the output pin for proper operation.

Table 2. DFN8 (4 x 4 mm) package pin description

Pin name	Pin number	Description
IN ⁽¹⁾	7, 8	Input voltage
GND	4	Ground
EN	6	Enable pin. The device is in OFF state when this pin is pulled low
ADJ/sense ⁽²⁾	3	Adjustable pin on ADJ version can be connected to external resistor divider to set the output voltage. Output sense pin on the fixed version has to be connected to V_{OUT}
OUT ⁽³⁾	1, 2	Output voltage
PG	5	Power Good
GND	Exposed pad	Exposed pad should be connected to GND

- Both of input pins have to be connected together on the board.
- The output sense pin of the fixed version has to be connected to the OUT pin for proper operation.
- Both of output pins have to be connected together on the board.

3 Typical application

Figure 3. LD39200 typical application schematic

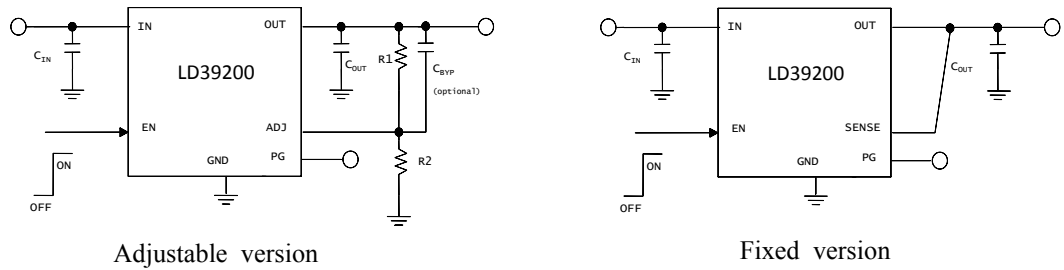

AM13909V1

Note: $R1$ and $R2$ are calculated according to the following formula: $R1 = R2 \times (V_{OUT} / V_{ADJ} - 1)$. Recommended value for C_{IN} and C_{OUT} is $10 \mu F$.

4 Maximum ratings

Table 3. Absolute maximum ratings

Symbol	Parameter	Value	Unit
V_{IN}	Input supply voltage	-0.3 to 7	V
V_{ADJ}	Adjustable voltage	-0.3 to 2	V
V_{OUT}/V_{SENSE}	Output voltage/output sense voltage	-0.3 to 7	V
I_{OUT}	Output current	Internally limited	A
EN	Enable pin voltage	-0.3 to 7	V
PG	Power Good pin voltage	-0.3 to 7	V
P_D	Power dissipation	Internally limited	W
ESD	Charge device model	±500	V
	Human body model	±2000	
T_{J-OP}	Operating junction temperature	-40 to 125	°C
T_{J-MAX}	Maximum junction temperature	150	°C
T_{STG}	Storage temperature	-55 to 150	°C

Note: Absolute maximum ratings are those values beyond which damage to the device may occur. Functional operation under these conditions is not implied.

Table 4. Thermal data

Symbol	Parameter	DFN6 (3 x 3 mm)	DFN8 (4 x 4 mm)	Unit
R_{THJC}	Junction-to-case thermal resistance	10	4	°C/W
R_{THJA}	Junction-to-ambient thermal resistance	55	40	

5 Electrical characteristics

($T_J = 25\text{ }^\circ\text{C}$, $V_{IN} = V_{OUT} + 1\text{ V}$; $V_{OUT} = V_{ADJ}$; $C_{IN} = 10\text{ }\mu\text{F}$; $C_{OUT} = 10\text{ }\mu\text{F}$; $I_{OUT} = 10\text{ mA}$; $V_{EN} = V_{IN}$)

Table 5. Electrical characteristics, adjustable version

Symbol	Parameter	Test conditions	Min.	Typ.	Max.	Unit
V_{IN}	Operating input voltage range		1.25		6.0	V
V_{ADJ}	Adjustable pin voltage			0.5		V
	Adjustable pin voltage accuracy	$T_J = 25\text{ }^\circ\text{C}$ $-40\text{ }^\circ\text{C} < T_J < 125\text{ }^\circ\text{C}$	-1.0 -2.0		1.0 2.0	%
I_{ADJ}	Adjustable pin current	$-40\text{ }^\circ\text{C} < T_J < 125\text{ }^\circ\text{C}$		100		nA
$\frac{\Delta V_{ADJ}\%}{\Delta V_{IN}}$	Static line regulation	$V_{OUT} + 1\text{ V} < V_{IN} < 6.0\text{ V}$; $T_J = 25\text{ }^\circ\text{C}$		0.01		%V
		$-40\text{ }^\circ\text{C} < T_J < 125\text{ }^\circ\text{C}$			0.2	
$\frac{\Delta V_{ADJ}\%}{\Delta I_{OUT}}$	Static load regulation	$0\text{ mA} < I_{OUT} < 2\text{ A}$; $T_J = 25\text{ }^\circ\text{C}$		0.1		%A
		$-40\text{ }^\circ\text{C} < T_J < 125\text{ }^\circ\text{C}$			0.4	
V_{DROP}	Dropout voltage ⁽¹⁾	$V_{IN} = 1.4\text{ V}$; $I_{OUT} = 1\text{ A}$; $-40\text{ }^\circ\text{C} < T_J < 125\text{ }^\circ\text{C}$		120	250	mV
		$V_{IN} = 2.5\text{ V}$; $I_{OUT} = 2\text{ A}$; $-40\text{ }^\circ\text{C} < T_J < 125\text{ }^\circ\text{C}$		135	250	
		$V_{IN} = 5.3\text{ V}$; $I_{OUT} = 2\text{ A}$; $-40\text{ }^\circ\text{C} < T_J < 125\text{ }^\circ\text{C}$		110	250	
eN	Output noise voltage	$V_{OUT} = V_{ADJ}$; $f = 10\text{ Hz to } 100\text{ kHz}$		45		$\mu\text{V}_{RMS} / V_{OUT}$
eN	Output noise voltage	$V_{IN} = V_{OUT} + 0.4\text{ V}$, $I_{OUT} = 700\text{ mA}$; $C_{IN} = C_{OUT} = 10\text{ }\mu\text{F}$, $R_2 = 10\text{ k}\Omega$, $R_1 = (V_{OUT} - 0.5) \times 20\text{ k}\Omega$, $C_{byp} = 470\text{ nF}$		24		μV_{RMS}
SVR	Supply voltage rejection	$V_{OUT} = 1.8\text{ V}$; $V_{IN} = V_{OUT} + 0.5\text{ V}$; $C_{OUT} = 10\text{ }\mu\text{F}$; $I_{OUT} = 10\text{ mA}$; $T_J = 25\text{ }^\circ\text{C}$; $f = 1\text{ kHz}$		70		dB
		$V_{OUT} = 1.8\text{ V}$; $V_{IN} = V_{OUT} + 0.5\text{ V}$; $C_{OUT} = 10\text{ }\mu\text{F}$; $I_{OUT} = 10\text{ mA}$; $T_J = 25\text{ }^\circ\text{C}$; $f = 100\text{ kHz}$		50		
		$V_{OUT} = 1.8\text{ V}$; $V_{IN} = V_{OUT} + 0.5\text{ V}$; $C_{OUT} = 10\text{ }\mu\text{F}$; $I_{OUT} = 10\text{ mA}$; $T_J = 25\text{ }^\circ\text{C}$; $f = 500\text{ kHz}$		50		dB
		$V_{OUT} = 1.8\text{ V}$; $V_{IN} = V_{OUT} + 0.5\text{ V}$; $C_{OUT} = 10\text{ }\mu\text{F}$; $I_{OUT} = 10\text{ mA}$; $T_J = 25\text{ }^\circ\text{C}$; $f = 1\text{ MHz}$		40		

Symbol	Parameter	Test conditions	Min.	Typ.	Max.	Unit
I _Q	Quiescent current	I _{OUT} = 0 A		100		μA
		I _{OUT} = 0 A; -40 °C < T _J < 125 °C			300	
		I _{OUT} = 2 A;		1		mA
		I _{OUT} = 2 A; -40 °C < T _J < 125 °C			3	
	Shutdown current	V _{EN} = 0, V _{IN} = 6 V		10		nA
I _{SC}	Short-circuit current	V _{OUT} = 0 V		3.5		A
I _{MIN}	Minimum output current				0	A
V _{EN}	Enable input logic low	1.25 V < V _{IN} < 6.0 V			0.5	V
	Enable input logic high	-40 °C < T _J < 125 °C	1.2			
I _{EN}	Enable pin input current	V _{EN} = V _{IN} ; 1.25 < V _{IN} < 6.0 V		10		nA
PG	Power Good output threshold	Rising edge		0.92* V _{out}		V
		Falling edge		0.8*V _{out}		
	Power Good output voltage low	I _{sink} = 6 mA open drain output			0.4	
T _{SHDN}	Thermal shutdown			170		°C
	Hysteresis			20		

1. Dropout voltage is the input-to-output voltage difference at which the output voltage is 100 mV below its nominal value; this specification does not apply to nominal output voltages below 1.2 V.

(T_J = 25 °C, V_{IN} = V_{OUT}+1 V; C_{IN} = 10 μF; C_{OUT} = 10 μF; I_{OUT} = 10 mA; V_{EN} = V_{IN})

Table 6. Electrical characteristics, fixed version

Symbol	Parameter	Test conditions	Min.	Typ.	Max.	Unit
V _{IN}	Operating input voltage range		1.25		6.0	V
V _{OUT}	Output voltage accuracy	T _J = 25 °C	-1.0		1.0	%
		-40 °C < T _J < 125 °C	-2.0		2.0	
ΔV _{ADJ} %/ ΔV _{IN}	Static line regulation	V _{OUT} + 1 V < V _{IN} < 6.0 V; T _J = 25 °C		0.01		%/ V
		-40 °C < T _J < 125 °C			0.1	
ΔV _{ADJ} %/ ΔI _{OUT}	Static load regulation	0 mA < I _{OUT} < 2 A; T _J = 25 °C		0.05		%/ A
		-40 °C < T _J < 125 °C			0.4	
V _{DROP}	Dropout voltage	V _{OUT} = 3.3 V; I _{OUT} = 2 A; -40 °C < T _J < 125 °C		130	250	mV
e _N	Output noise voltage	V _{OUT} = 2.5 V; f = 10 Hz to 100 kHz		40		μV _{RMS} /V _{OUT}

Symbol	Parameter	Test conditions	Min.	Typ.	Max.	Unit
SVR	Supply voltage rejection	$V_{OUT} = 1.8\text{ V}; V_{IN} = V_{OUT} + 0.5\text{ V};$ $C_{OUT} = 10\text{ }\mu\text{F}; I_{OUT} = 10\text{ mA};$ $T_J = 25\text{ }^\circ\text{C}; f = 1\text{ kHz}$		70		dB
		$V_{OUT} = 1.8\text{ V}; V_{IN} = V_{OUT} + 0.5\text{ V};$ $C_{OUT} = 10\text{ }\mu\text{F}; I_{OUT} = 10\text{ mA};$ $T_J = 25\text{ }^\circ\text{C}; f = 100\text{ kHz}$		50		
		$V_{OUT} = 1.8\text{ V}; V_{IN} = V_{OUT} + 0.5\text{ V};$ $C_{OUT} = 10\text{ }\mu\text{F}; I_{OUT} = 10\text{ mA};$ $T_J = 25\text{ }^\circ\text{C}; f = 500\text{ kHz}$		50		
		$V_{OUT} = 1.8\text{ V}; V_{IN} = V_{OUT} + 0.5\text{ V};$ $C_{OUT} = 10\text{ }\mu\text{F}; I_{OUT} = 10\text{ mA};$ $T_J = 25\text{ }^\circ\text{C}; f = 1\text{ MHz}$		40		
I_Q	Quiescent current	$I_{OUT} = 0\text{ A}$		100		μA
		$I_{OUT} = 0\text{ A}; -40\text{ }^\circ\text{C} < T_J < 125\text{ }^\circ\text{C}$			300	
		$I_{OUT} = 2\text{ A};$		1		mA
		$I_{OUT} = 2\text{ A}; -40\text{ }^\circ\text{C} < T_J < 125\text{ }^\circ\text{C}$			3	
	Shutdown current	$V_{EN} = 0, V_{IN} = 6\text{ V}$		50		nA
I_{SC}	Short-circuit current	$V_{OUT} = 0\text{ V}$		3.5		A
I_{MIN}	Minimum output current				0	A
V_{EN}	Enable input logic low	$1.25\text{ V} < V_{IN} < 6.0\text{ V}$			0.5	V
	Enable input logic high	$-40\text{ }^\circ\text{C} < T_J < 125\text{ }^\circ\text{C}$	1.2			
I_{EN}	Enable pin input current	$V_{EN} = V_{IN}; 1.25 < V_{IN} < 6.0\text{ V}$		10		nA
PG	Power Good output threshold	Rising edge		$0.92 \cdot V_{OUT}$		V
		Falling edge		$0.8 \cdot V_{OUT}$		
	Power Good output voltage low	$I_{sink} = 6\text{ mA}$ open drain output				
T_{SHDN}	Thermal shutdown			170		$^\circ\text{C}$
	Hysteresis			20		

6 Application information

6.1 Thermal and short-circuit protections

The LD39200 is self-protected from short-circuit conditions and overtemperature. When the output load is higher than the one supported by the device, the output current rises until the limit of typically 3.5 A is reached; at this point the current is kept constant even when the load impedance is zero. The thermal protection acts when the junction temperature reaches 170 °C. The IC enters the shutdown status. As soon as the junction temperature falls again below 150 °C the device starts working again. In order to calculate the maximum power the device can dissipate, keeping the junction temperature below T_{J-OP} , the following formula is used:

$$P_{DMAX} = (125 - T_{AMB}) / R_{THJ} - A \quad (1)$$

6.2 Output voltage setting for ADJ version

In the adjustable version, the output voltage can be set from 0.5 V up to the input voltage minus the voltage drop across the pass transistor (dropout voltage), by connecting a resistor divider between the ADJ pin and the output, allowing remote voltage sensing. The resistor divider can be selected using the following equation:

$$V_{OUT} = V_{ADJ}(1 + R1 / R2), \text{ with } V_{ADJ} = 0.5 V \text{ (typ.)} \quad (2)$$

6.3 Enable pin

The LD39200 features an enable function. When the EN voltage is higher than 1.2 V the device is ON, and if it is lower than 0.5 V the device is OFF. In shutdown mode, the total current consumption is 10 nA (typ). The EN pin does not have an internal pull-up, therefore it cannot be left floating if it is not used.

6.4 Power Good pin (PG)

Some applications require a flag showing that the output voltage is in the correct range. Power Good threshold depends on the output voltage. When the output voltage is higher than $0.92 * V_{OUT(nom)}$, the PG pin goes to high impedance. If the output voltage is below $0.80 * V_{OUT(nom)}$ the PG pin goes to low impedance. If the device works well, the PG pin is at high impedance.

6.5 Reverse current protection

The device avoids the reverse current to flow from the output to the input during any operating condition ($EN = 0$ or $EN = 1, V_{IN} > V_{OUT} + V_{DROP}$). During fast turn-on/off this function prevents a big current from flowing to the input. Moreover it is used to avoid the reverse current to flow from the output pin to the input one, when other power supplies, providing a voltage higher than the input voltage, are connected to the output pin. If a power supply, providing a voltage lower than LDO output voltage, is connected to OUT pin, LDO works in current protection, causing high power dissipation inside the device.

When the device is disabled ($EN = \text{low}$) and $V_{OUT} > 0 V$, a small current (few μA) is sunk from the OUT pin.

7 Typical performance characteristics

(The following plots are referred to the typical application circuit and, unless otherwise noted, at $T_A = 25\text{ }^\circ\text{C}$)

Figure 4. Dropout voltage vs. temperature
($V_{in} = 1.3\text{ V}$, $I_{out} = 1\text{ A}$)

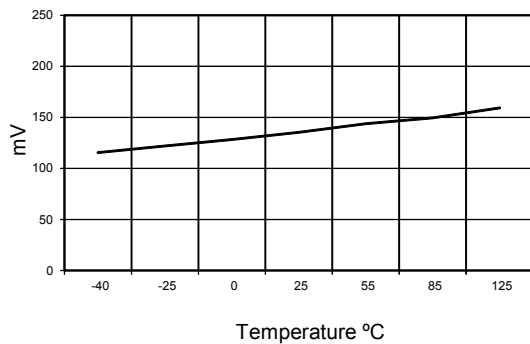

AM13910V1

Figure 5. Dropout voltage vs. temperature
($V_{in} = 1.4\text{ V}$, $I_{out} = 1\text{ A}$)

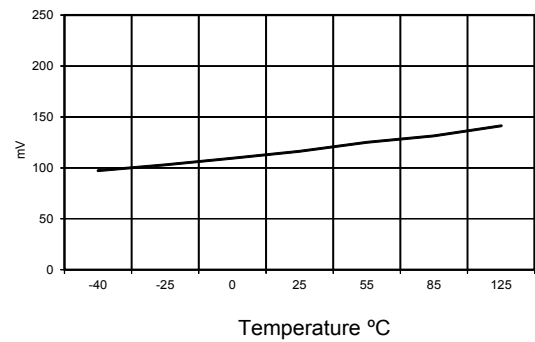

AM13911V1

Figure 6. Dropout voltage vs. temperature
($V_{in} = 1.4\text{ V}$, $I_{out} = 2\text{ A}$)

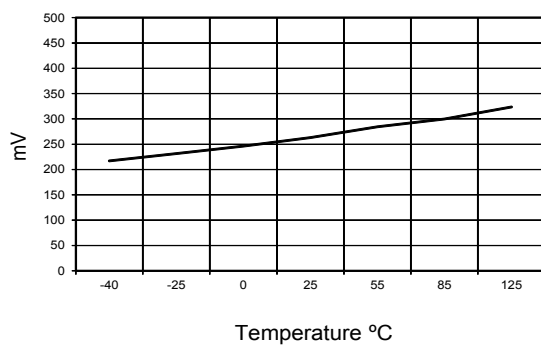

AM13912V1

Figure 7. Dropout voltage vs. temperature
($V_{in} = 1.5\text{ V}$, $I_{out} = 1\text{ A}$)

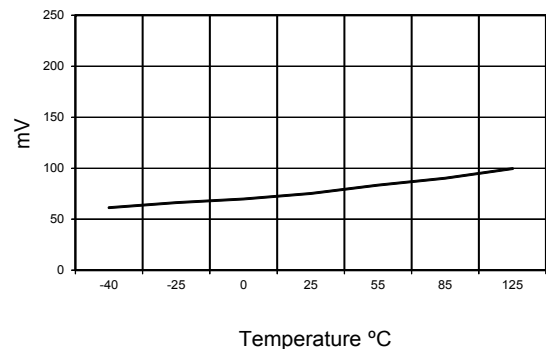

AM13913V1

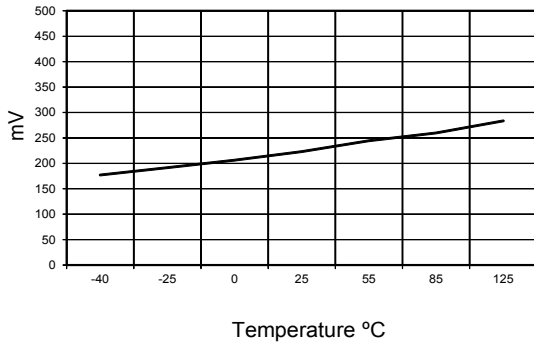
Figure 8. Dropout voltage vs. temperature
 ($V_{in} = 1.5\text{ V}$, $I_{out} = 2\text{ A}$)

AM13914V1

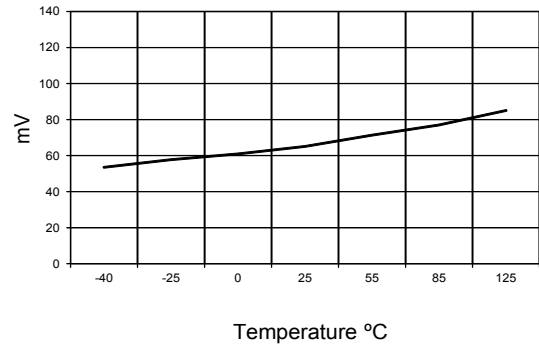
Figure 9. Dropout voltage vs. temperature
 ($V_{in} = 2.5\text{ V}$, $I_{out} = 1\text{ A}$)

AM13915V1

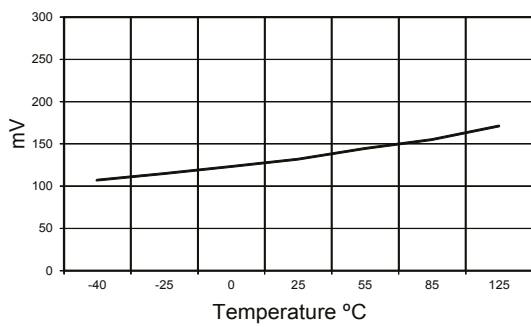
Figure 10. Dropout voltage vs. temperature
 ($V_{in} = 2.5\text{ V}$, $I_{out} = 2\text{ A}$)

AM13916V1

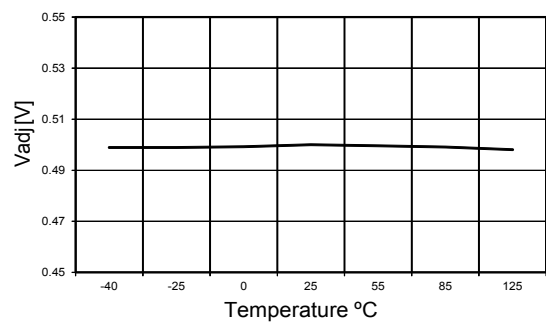
Figure 11. Reference voltage vs. temperature
 ($V_{in} = 1.5\text{ V}$, $I_{out} = 10\text{ mA}$)

AM13917V1

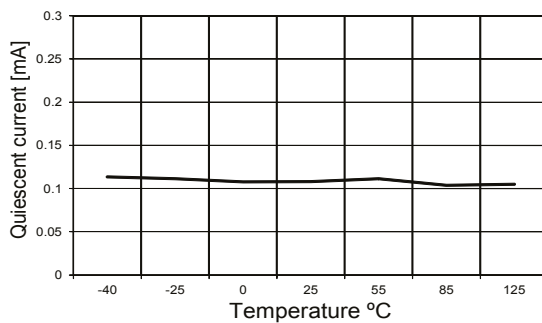
Figure 12. Quiescent current vs. temperature
 ($V_{in} = 1.5\text{ V}$, $I_{out} = 0\text{ mA}$)

AM13918V1

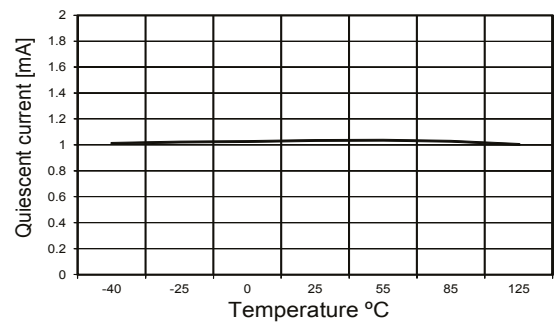
Figure 13. Quiescent current vs. temperature
 ($V_{in} = 1.5\text{ V}$, $I_{out} = 2\text{ A}$)

AM13919V1

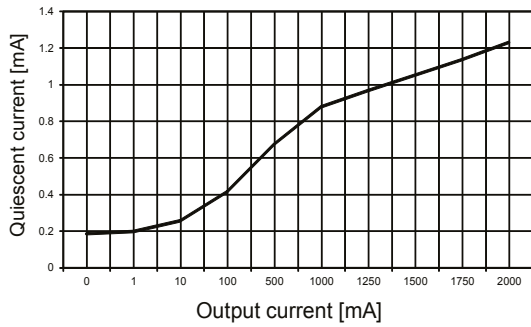
Figure 14. Quiescent current vs. output current

AM13920V2

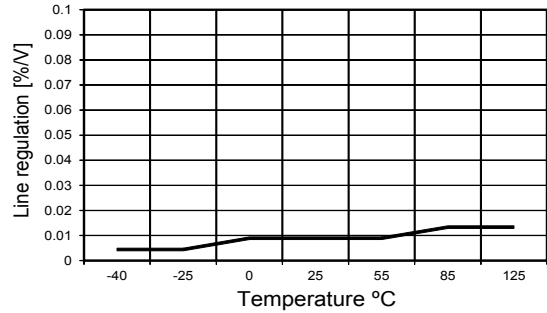
Figure 15. Line regulation vs. temperature (1.5 V ≤ Vin ≤ 6 V, Iout = 10 mA)

AM13920V1

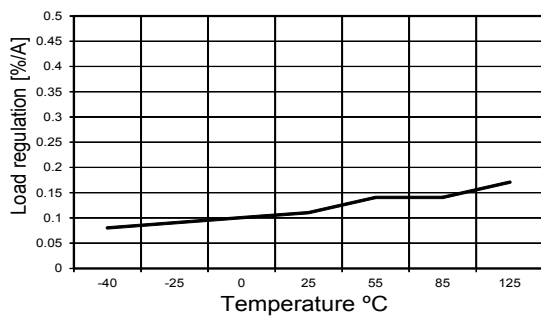
Figure 16. Load regulation vs. temperature (Vin = 1.5 V, 0 < Iout < 2 A)

AM13921V1

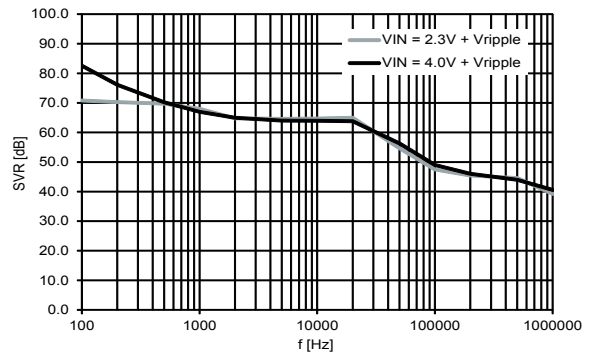
Figure 17. SVR vs. frequency

AM13922V1

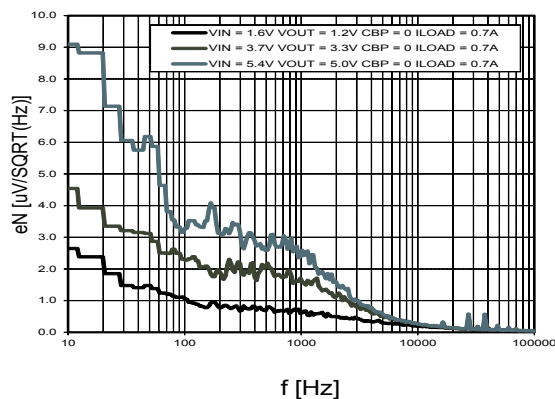
Figure 18. Noise spectral density (no Cbyp)

AM13923V1

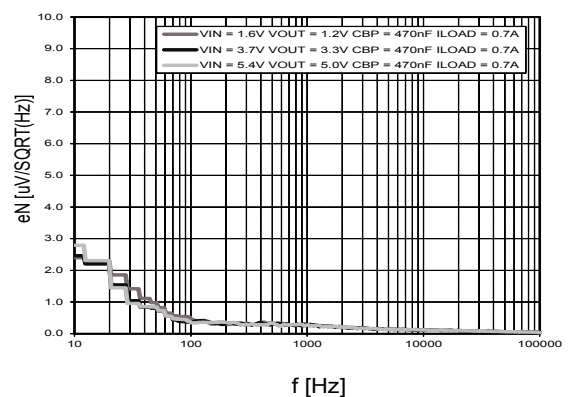
Figure 19. Noise spectral density (Cbyp = 470 nF)

AM13924V1

Figure 20. Stability plan

Figure 21. Enable startup, $V_{IN} = 1.25\text{ V}$, $I_{OUT} = 2\text{ A}$

Figure 22. Enable startup, $V_{IN} = 6\text{ V}$, $I_{OUT} = 2\text{ A}$

Figure 23. Enable startup, no Cbyp

Figure 24. Enable startup, $C_{byp} = 470\text{ nF}$

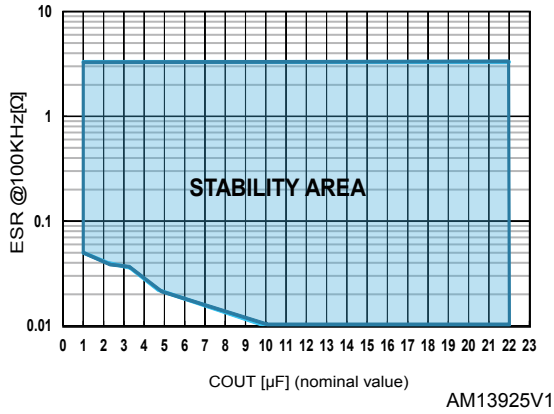
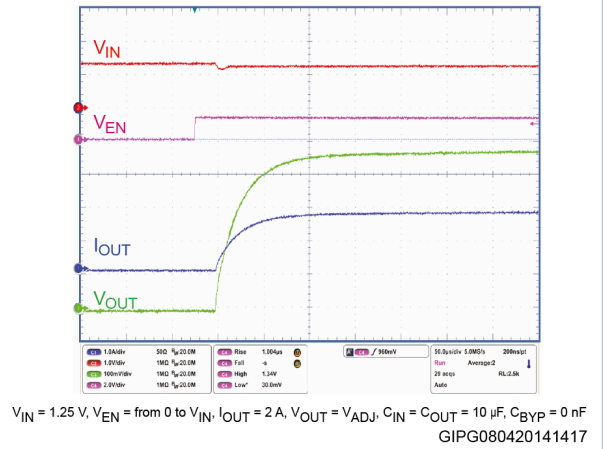
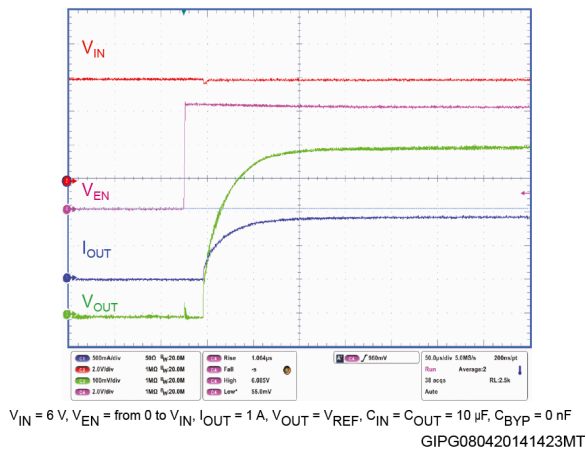
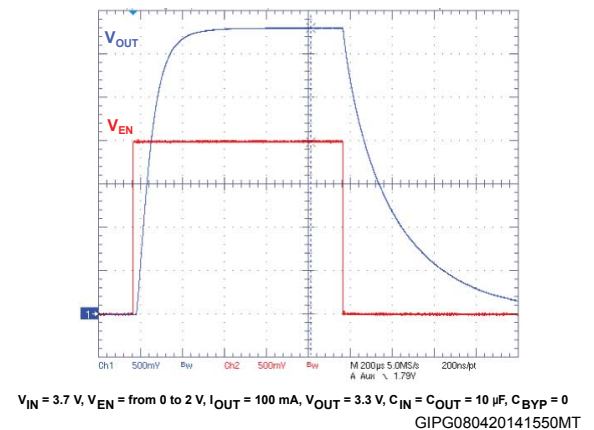
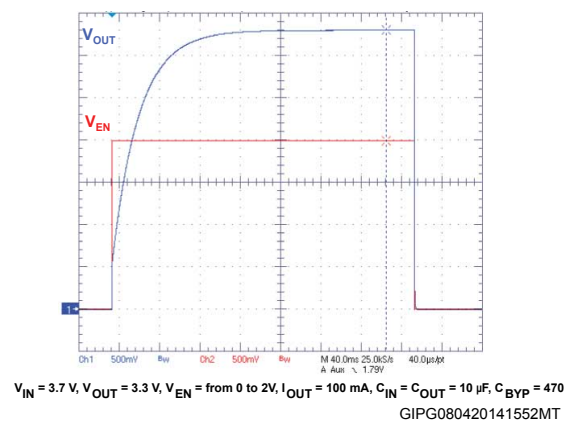
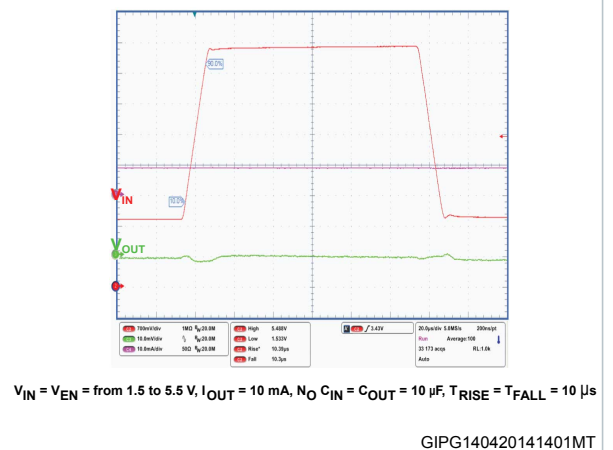
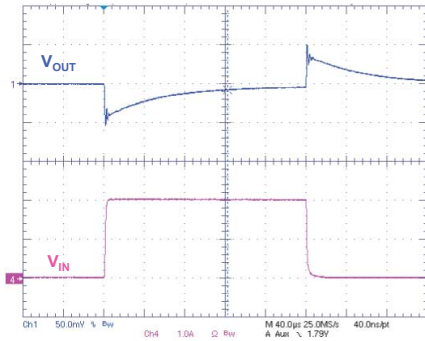
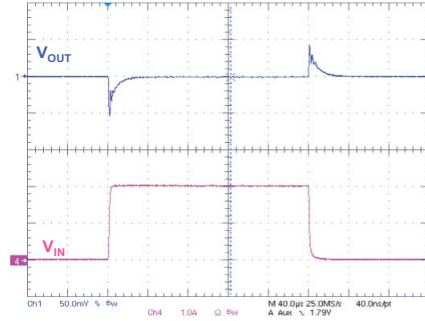
Figure 25. Line transient

Figure 26. Load transient, no C_{byp}

 $V_{IN} = 3.7\text{ V}, V_{OUT} = 3.3\text{ V}, I_{LOAD} = 10\text{ mA to } 2\text{ A}, C_{BYP} = 0$

GIPG140420141403MT

Figure 27. Load transient, C_{byp} = 470 nF

 $V_{IN} = 3.7\text{ V}, V_{OUT} = 3.3\text{ V}, I_{LOAD} = 10\text{ mA to } 2\text{ A}, C_{BYP} = 470\text{ nF}$

GIPG140420141405MT

8 Package mechanical data

In order to meet environmental requirements, ST offers these devices in different grades of ECOPACK® packages, depending on their level of environmental compliance. ECOPACK® specifications, grade definitions and product status are available at: www.st.com. ECOPACK® is an ST trademark.

8.1 DFN6 (3 x 3 mm) mechanical data

Figure 28. DFN6 (3 x 3 mm) package outline

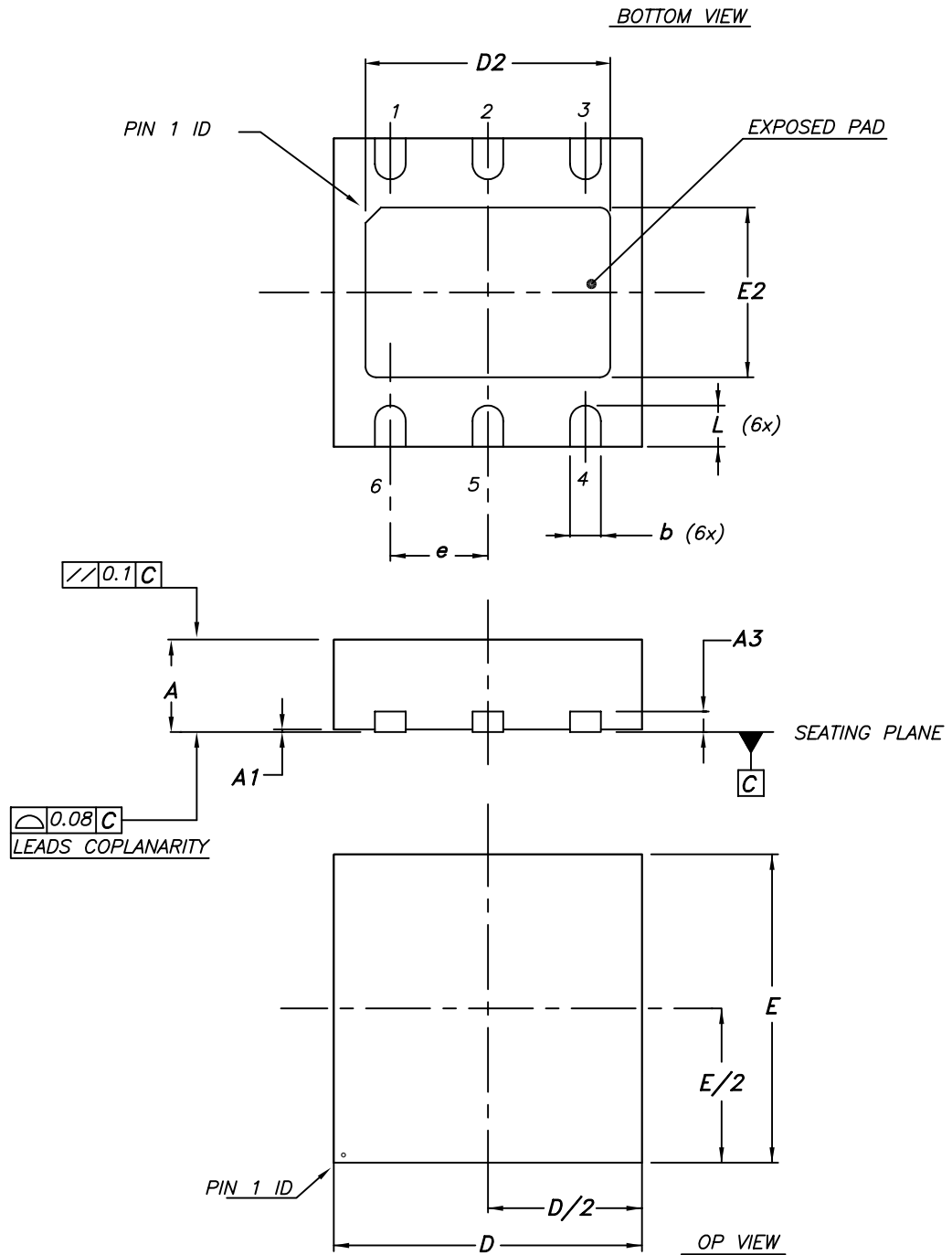

7946637_C

Table 7. DFN6 (3 x 3 mm) mechanical data

Dim.	mm		
	Min.	Typ.	Max.
A	0.80		1
A1	0	0.02	0.05
A3		0.20	
b	0.23		0.45
D	2.90	3	3.10
D2	2.23		2.50
E	2.90	3	3.10
E2	1.50		1.75
e		0.95	
L	0.30	0.40	0.50

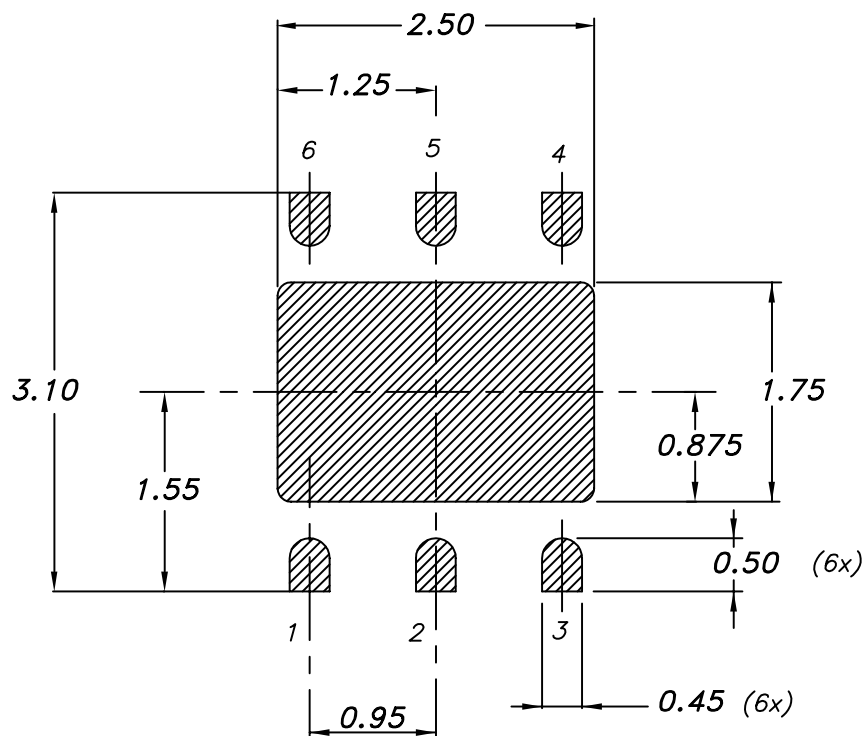
Figure 29. DFN6 (3 x 3 mm) recommended footprint (all dimensions are in mm)

7946637_C

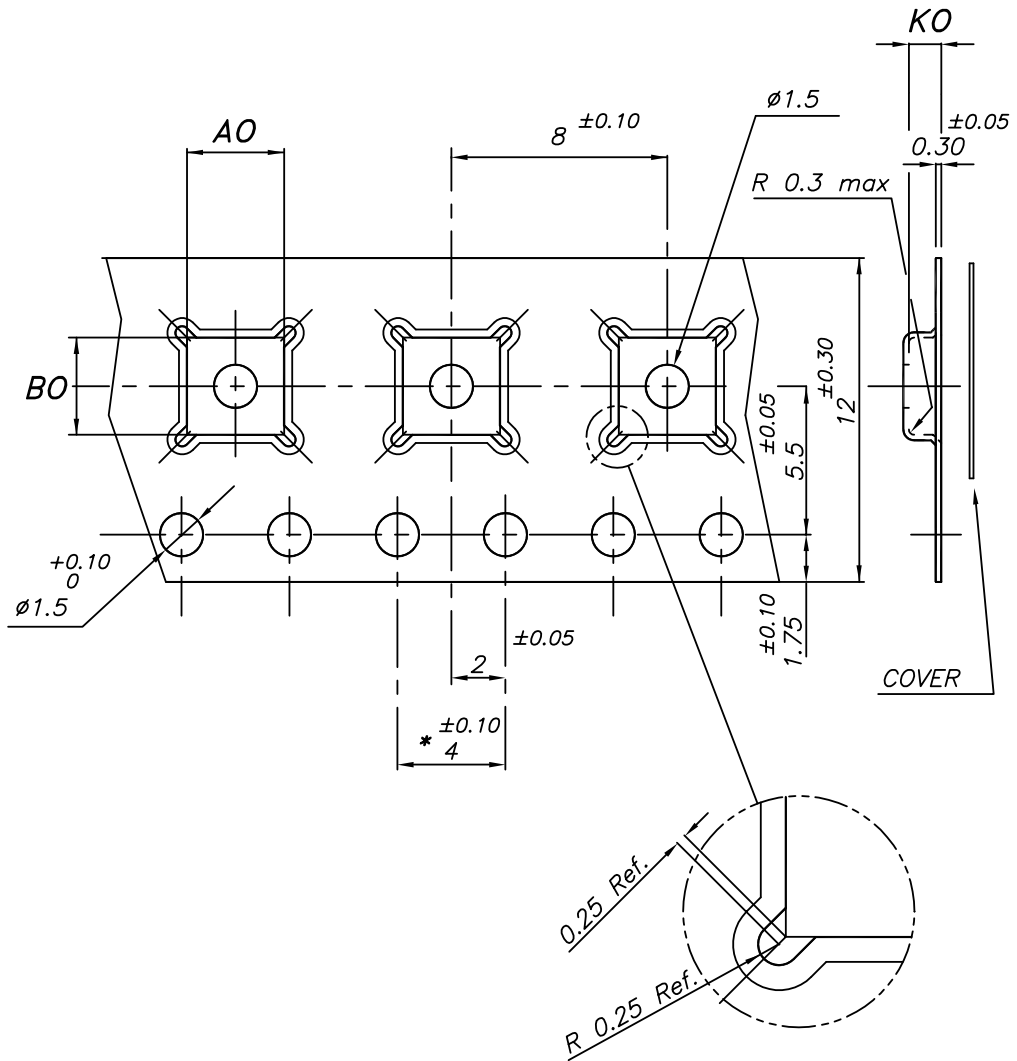
8.2 DFN6 (3 x 3 mm) tape and reel mechanical data
Figure 30. DFN6 (3 x 3 mm) tape outline

* - 10 SPROCKET HOLE PITCH CUMULATIVE TOLERANCE ± 0.20

7875978_N

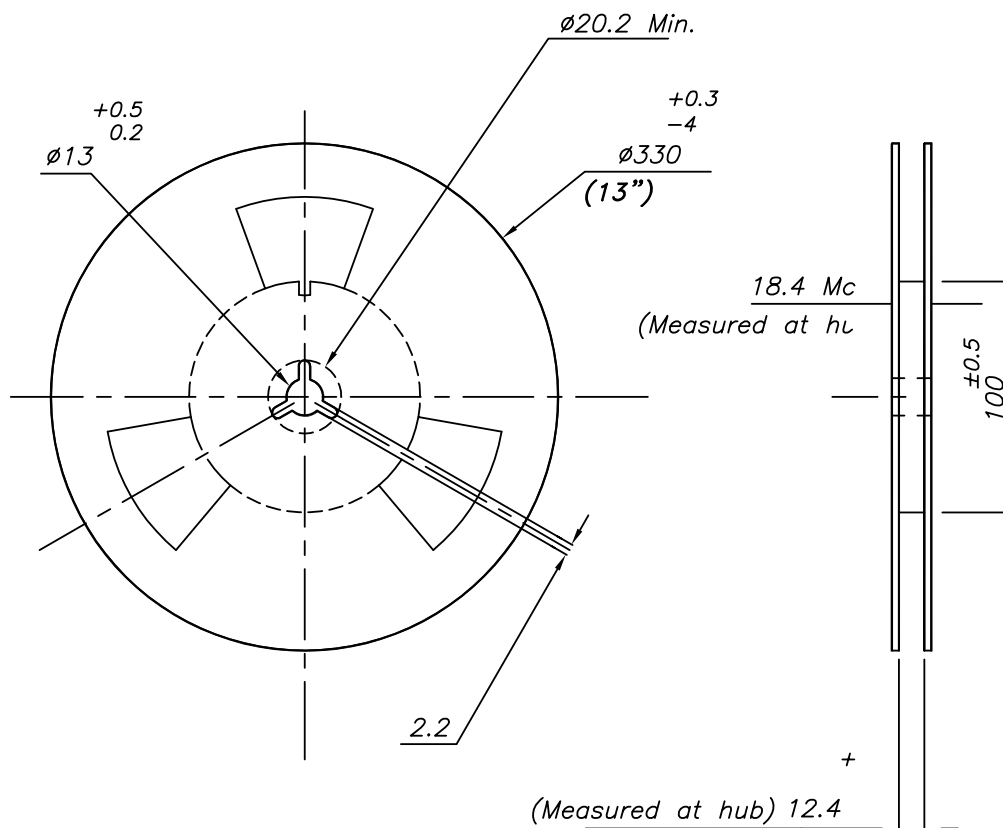
Figure 31. DFN6 (3 x 3 mm) reel outline

7875978_N

Table 8. DFN6 (3 x 3 mm) tape and reel mechanical data

Dim.	mm		
	Min.	Typ.	Max.
A0	3.20	3.30	3.40
B0	3.20	3.30	3.40
K0	1	1.10	1.20

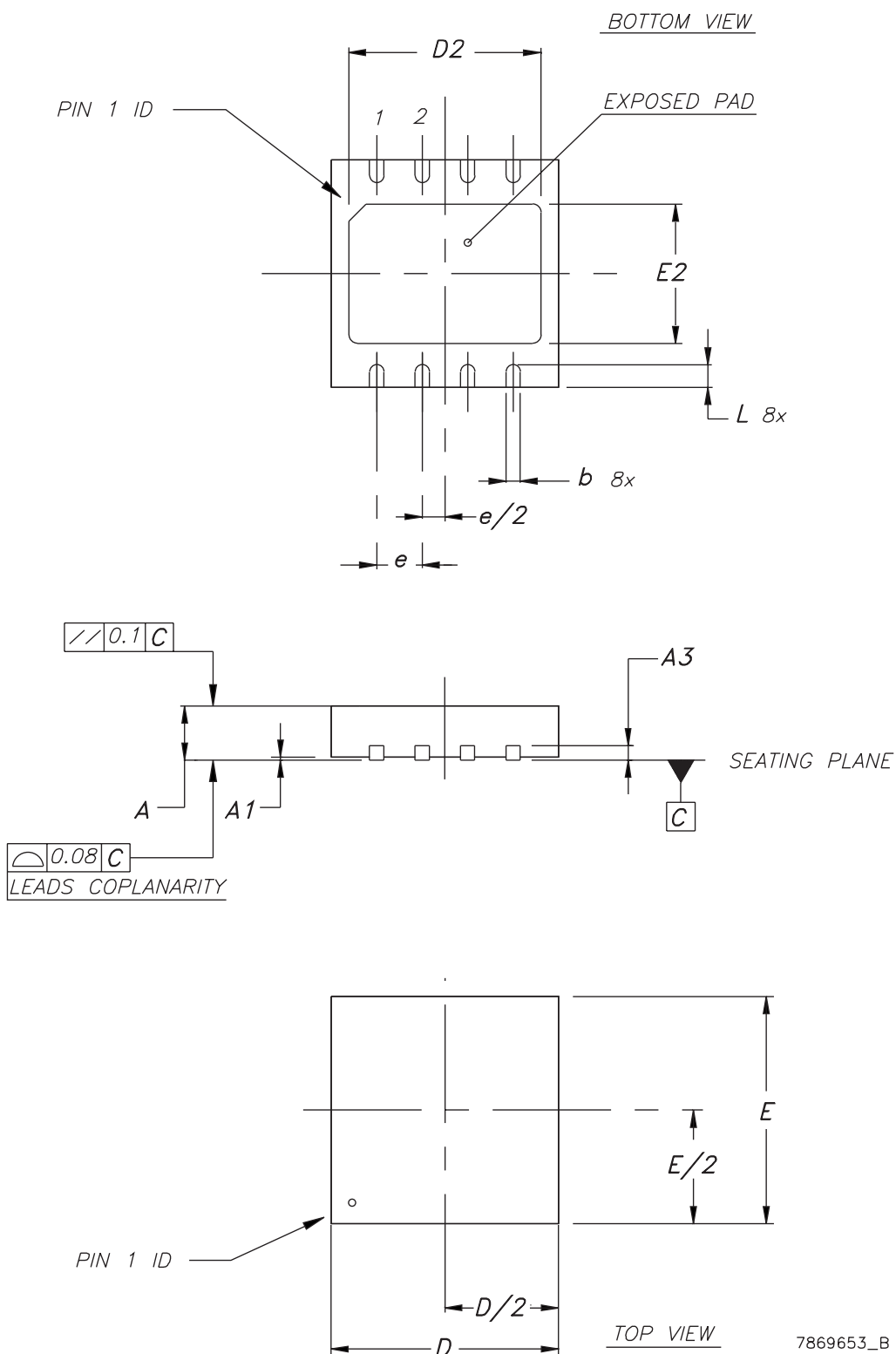
8.3 DFN8 (4 x 4 mm) mechanical data
Figure 32. DFN8 (4 x 4 mm) package outline

7869653_B

Table 9. DFN8 (4 x 4 mm) mechanical data

Dim.	mm		
	Min.	Typ.	Max.
A	0.80	0.90	1
A1	0	0.02	0.05
A3		0,20	
b	0.23	0.30	0.38
D	3.90	4	4.10
D2	2.82	3	3.23
E	3.90	4	4.10
E2	2.05	2.20	2.30
e		0.80	
L	0.40	0.50	0.60

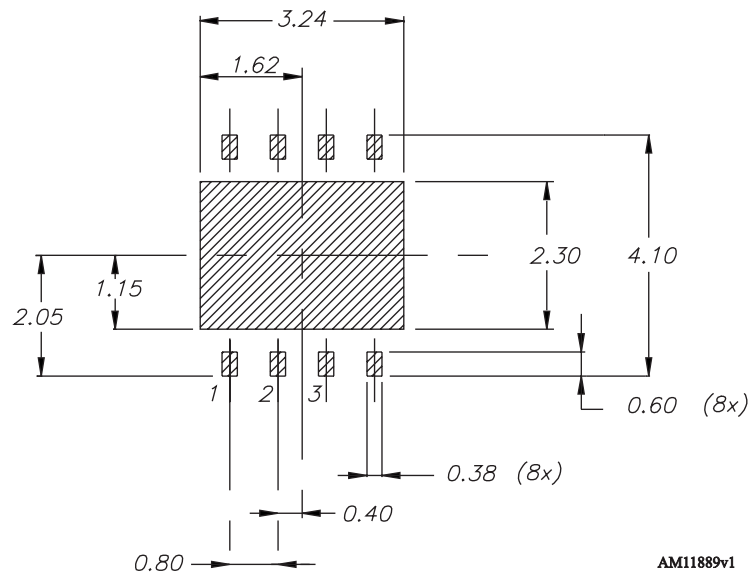
Figure 33. DFN8 (4 x 4 mm) recommended footprint (all dimensions are in mm)

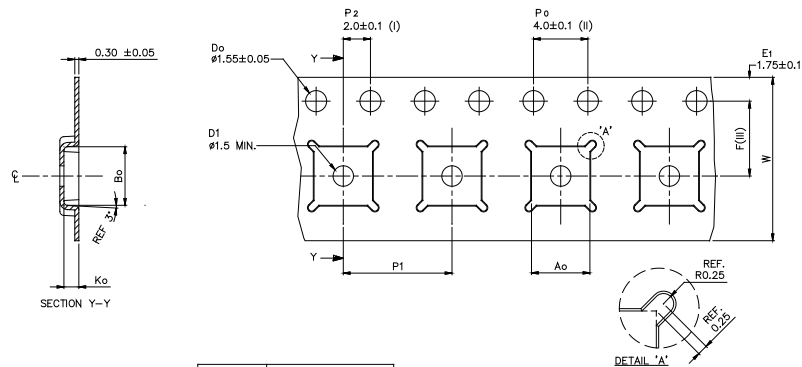
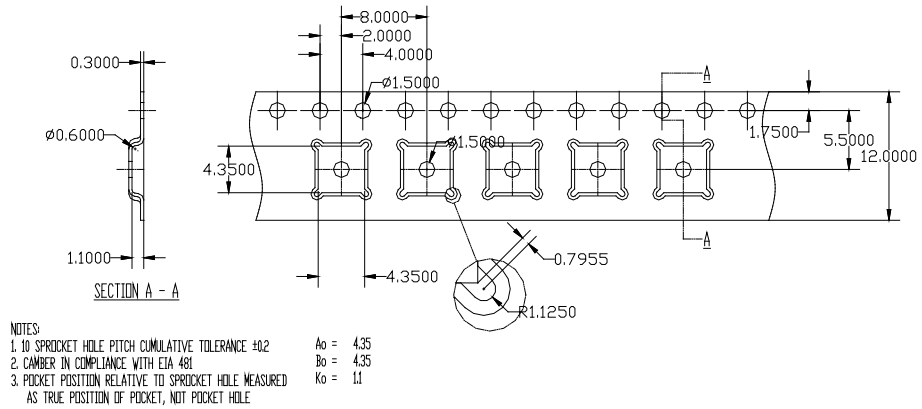
8.4 DFN8 (4 x 4 mm) reel mechanical data
Figure 34. DFN8 (4 x 4 mm) tape outline (all dimensions are in mm)

A_0	4.30 \pm 0.1
B_0	4.30 \pm 0.1
K_0	1.10 \pm 0.1
F	5.50 \pm 0.1
P_1	8.00 \pm 0.1
W	12.00 \pm 0.3

- (I) Measured from centreline of sprocket hole to centreline of pocket.
- (II) Cumulative tolerance of 10 sprocket holes is ± 0.20 .
- (III) Measured from centreline of sprocket hole to centreline of pocket.
- (IV) Other material available.

7279936

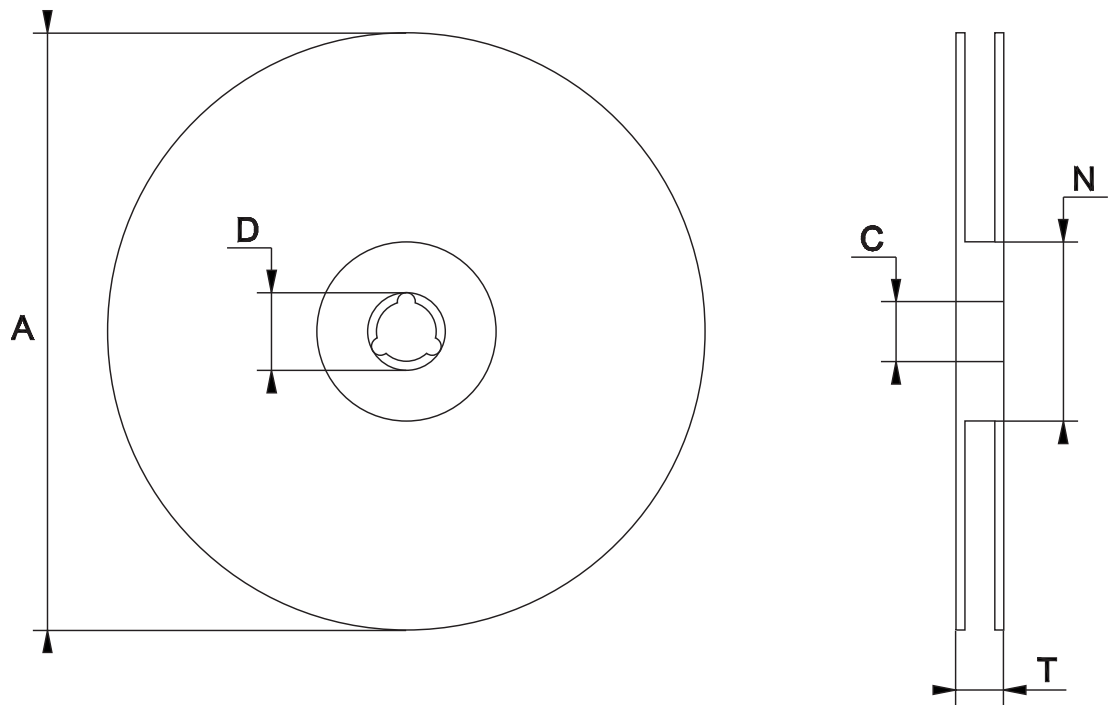
Figure 35. DFN8 (4 x 4 mm) reel outline

Note: Drawing not in scale

Table 10. DFN8 (4 x 4 mm) reel mechanical data

Dim.	mm		
	Min.	Typ.	Max.
A			330
C	12.8	13.0	13.2
D	20.2		
N	60		
T			22.4

9 Ordering information

Table 11. Order codes

DFN6 (3 x 3 mm)	DFN8 (4 x 4 mm)	Output voltage
LD39200PUR	LD39200DPUR	ADJ
LD39200PU33R		3.3 V

Revision history

Table 12. Document revision history

Date	Revision	Changes
08-Jul-2014	1	Initial release.
06-Jul-2017	2	Updated Table 11: "Order codes". Minor text changes.
17-Sep-2018	3	Updated note Section 3 Typical application .

Contents

1	Block diagram	2
2	Pin configuration and description	3
3	Typical application	4
4	Maximum ratings	5
5	Electrical characteristics	6
6	Application information	9
6.1	Thermal and short-circuit protections	9
6.2	Output voltage setting for ADJ version	9
6.3	Enable pin	9
6.4	Power Good pin (PG)	9
6.5	Reverse current protection	9
7	Typical performance characteristics	10
8	Package information	15
8.1	DFN6 (3 x 3 mm) package information	15
8.2	DFN6 (3 x 3 mm) packing information	17
8.3	DFN8 (4 x 4 mm) package information	19
8.4	DFN8 (4 x 4 mm) packing information	21
9	Ordering information	24
	Revision history	25

List of tables

Table 1.	DFN6 (3 x 3 mm) package pin description	3
Table 2.	DFN8 (4 x 4 mm) package pin description	3
Table 3.	Absolute maximum ratings	5
Table 4.	Thermal data	5
Table 5.	Electrical characteristics, adjustable version	6
Table 6.	Electrical characteristics, fixed version	7
Table 7.	DFN6 (3 x 3 mm) mechanical data	17
Table 8.	DFN6 (3 x 3 mm) tape and reel mechanical data	19
Table 9.	DFN8 (4 x 4 mm) mechanical data	21
Table 10.	DFN8 (4 x 4 mm) reel mechanical data	23
Table 11.	Order codes	24
Table 12.	Document revision history	25

List of figures

Figure 1.	Block diagram	2
Figure 2.	Pin configuration (top view)	3
Figure 3.	LD39200 typical application schematic	4
Figure 4.	Dropout voltage vs. temperature ($V_{in} = 1.3\text{ V}$, $I_{out} = 1\text{ A}$)	10
Figure 5.	Dropout voltage vs. temperature ($V_{in} = 1.4\text{ V}$, $I_{out} = 1\text{ A}$)	10
Figure 6.	Dropout voltage vs. temperature ($V_{in} = 1.4\text{ V}$, $I_{out} = 2\text{ A}$)	10
Figure 7.	Dropout voltage vs. temperature ($V_{in} = 1.5\text{ V}$, $I_{out} = 1\text{ A}$)	10
Figure 8.	Dropout voltage vs. temperature ($V_{in} = 1.5\text{ V}$, $I_{out} = 2\text{ A}$)	11
Figure 9.	Dropout voltage vs. temperature ($V_{in} = 2.5\text{ V}$, $I_{out} = 1\text{ A}$)	11
Figure 10.	Dropout voltage vs. temperature ($V_{in} = 2.5\text{ V}$, $I_{out} = 2\text{ A}$)	11
Figure 11.	Reference voltage vs. temperature ($V_{in} = 1.5\text{ V}$, $I_{out} = 10\text{ mA}$)	11
Figure 12.	Quiescent current vs. temperature ($V_{in} = 1.5\text{ V}$, $I_{out} = 0\text{ mA}$)	11
Figure 13.	Quiescent current vs. temperature ($V_{in} = 1.5\text{ V}$, $I_{out} = 2\text{ A}$)	11
Figure 14.	Quiescent current vs. output current	12
Figure 15.	Line regulation vs. temperature ($1.5\text{ V} \leq V_{in} \leq 6\text{ V}$, $I_{out} = 10\text{ mA}$)	12
Figure 16.	Load regulation vs. temperature ($V_{in} = 1.5\text{ V}$, $0 < I_{out} < 2\text{ A}$)	12
Figure 17.	SVR vs. frequency	12
Figure 18.	Noise spectral density (no C _{by})	12
Figure 19.	Noise spectral density (C _{by} = 470 nF)	12
Figure 20.	Stability plan	13
Figure 21.	Enable startup, $V_{in} = 1.25\text{ V}$, $I_{out} = 2\text{ A}$	13
Figure 22.	Enable startup, $V_{in} = 6\text{ V}$, $I_{out} = 2\text{ A}$	13
Figure 23.	Enable startup, no C _{by}	13
Figure 24.	Enable startup, C _{by} = 470 nF	13
Figure 25.	Line transient	13
Figure 26.	Load transient, no C _{by}	14
Figure 27.	Load transient, C _{by} = 470 nF	14
Figure 28.	DFN6 (3 x 3 mm) package outline	16
Figure 29.	DFN6 (3 x 3 mm) recommended footprint (all dimensions are in mm)	17
Figure 30.	DFN6 (3 x 3 mm) tape outline	18
Figure 31.	DFN6 (3 x 3 mm) reel outline	19
Figure 32.	DFN8 (4 x 4 mm) package outline	20
Figure 33.	DFN8 (4 x 4 mm) recommended footprint (all dimensions are in mm)	21
Figure 34.	DFN8 (4 x 4 mm) tape outline (all dimensions are in mm)	22
Figure 35.	DFN8 (4 x 4 mm) reel outline	23

IMPORTANT NOTICE – PLEASE READ CAREFULLY

STMicroelectronics NV and its subsidiaries (“ST”) reserve the right to make changes, corrections, enhancements, modifications, and improvements to ST products and/or to this document at any time without notice. Purchasers should obtain the latest relevant information on ST products before placing orders. ST products are sold pursuant to ST’s terms and conditions of sale in place at the time of order acknowledgement.

Purchasers are solely responsible for the choice, selection, and use of ST products and ST assumes no liability for application assistance or the design of Purchasers’ products.

No license, express or implied, to any intellectual property right is granted by ST herein.

Resale of ST products with provisions different from the information set forth herein shall void any warranty granted by ST for such product.

ST and the ST logo are trademarks of ST. All other product or service names are the property of their respective owners.

Information in this document supersedes and replaces information previously supplied in any prior versions of this document.

© 2018 STMicroelectronics – All rights reserved

单击下面可查看定价，库存，交付和生命周期等信息

[>>STMicro\(意法半导体\)](#)