

## 16 A standard SCRs

### Features

- $I_{T(RMS)} = 16 \text{ A}$
- $V_{DRM}/V_{RRM} = 600 \text{ to } 1000 \text{ V}$
- $I_{GT} = 25 \text{ mA}$

### Description

The standard TN16 / TYNx16 16 A SCRs series is suitable for general purpose applications.

Using clip assembly technology, they provide a superior performance in surge current capabilities.

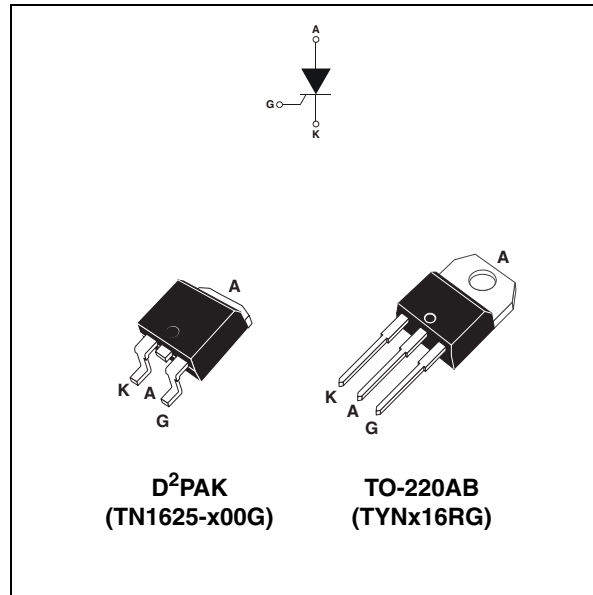

**Table 1. Device summary**

Parameter	TN1625-600G TYN616RG	TYN816RG	TN1625-1000G	Unit
$V_{DRM}/V_{RRM}$	600	800	1000	V
Sensitivity	25	25	25	mA

# 1 Characteristics

**Table 2. Absolute ratings (limiting values)**

Symbol	Parameter		Value	Unit	
$I_{T(RMS)}$	RMS on-state current (180 °Conduction angle)		$T_c = 110\text{ °C}$	16	A
$I_{T(AV)}$	Average on-state current (180 °Conduction angle)		$T_c = 110\text{ °C}$	10	A
$I_{TSM}$	Non repetitive surge peak on-state current	$t_p = 8.3\text{ ms}$	$T_j = 25\text{ °C}$	200	A
		$t_p = 10\text{ ms}$		190	
$I^2t$	$I^2t$ Value for fusing	$t_p = 10\text{ ms}$	$T_j = 25\text{ °C}$	180	$A^2s$
dI/dt	Critical rate of rise of on-state current $I_G = 2 \times I_{GT}$ , $t_r \leq 100\text{ ns}$	F = 60 Hz	$T_j = 125\text{ °C}$	50	A/ $\mu s$
$I_{GM}$	Peak gate current	$t_p = 20\text{ }\mu s$	$T_j = 125\text{ °C}$	4	A
$P_{G(AV)}$	Average gate power dissipation		$T_j = 125\text{ °C}$	1	W
$T_{stg}$ $T_j$	Storage junction temperature range Operating junction temperature range			- 40 to + 150 - 40 to + 125	°C
$V_{RGM}$	Maximum peak reverse gate voltage			5	V

**Table 3. Electrical characteristics ( $T_j = 25\text{ °C}$ , unless otherwise specified)**

Symbol	Test Conditions		Value	Unit		
$I_{GT}$	$V_D = 12\text{ V}$ $R_L = 33\text{ }\Omega$	MIN.	2	mA		
		MAX.	25			
$V_{GT}$		MAX.	1.3	V		
$V_{GD}$	$V_D = V_{DRM}$ $R_L = 3.3\text{ k}\Omega$	$T_j = 125\text{ °C}$	MIN.	0.2	V	
$I_H$	$I_T = 500\text{ mA}$ Gate open		MAX.	40	mA	
$I_L$	$I_G = 1.2 \times I_{GT}$		MAX.	60	mA	
dV/dt	$V_D = 67\% V_{DRM}$ Gate open	$T_j = 125\text{ °C}$	MIN.	500	V/ $\mu s$	
$V_{TM}$	$I_{TM} = 32\text{ A}$ $t_p = 380\text{ }\mu s$	$T_j = 25\text{ °C}$	MAX.	1.6	V	
$V_{t0}$	Threshold voltage		$T_j = 125\text{ °C}$	MAX.	0.77	V
$R_d$	Dynamic resistance		$T_j = 125\text{ °C}$	MAX.	23	m $\Omega$
$I_{DRM}$ $I_{RRM}$	$V_{DRM} = V_{RRM}$	$T_j = 25\text{ °C}$	MAX.	5	$\mu A$	
		$T_j = 125\text{ °C}$		2	mA	

**Table 4. Thermal resistance**

Symbol	Parameter		Value	Unit
$R_{th(j-c)}$	Junction to case (DC)		1.1	°C/W
$R_{th(j-a)}$	Junction to ambient (DC)	S = 01 cm <sup>2</sup> D <sup>2</sup> PAK	45	°C/W
		TO-220AB	60	

S = copper surface under tab



**Figure 1. Maximum average power dissipation versus average on-state current**

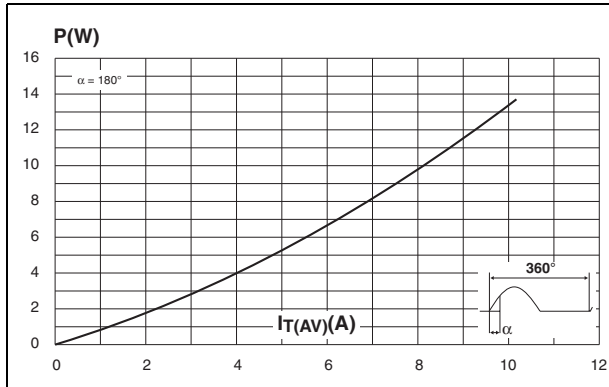

**Figure 2. Average and D.C. on-state current versus case temperature**

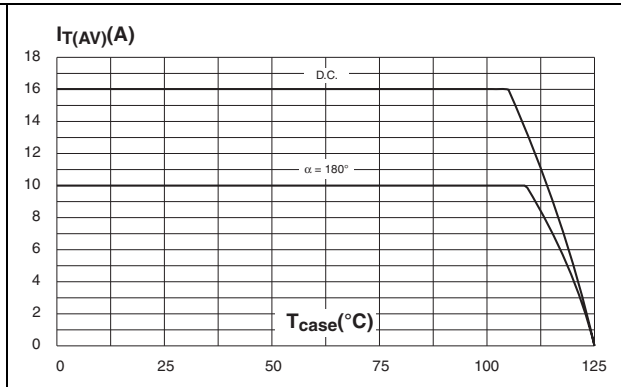

**Figure 3. Average and D.C. on-state current versus ambient temperature (copper surface under tab: S=1cm²) (D²PAK)**

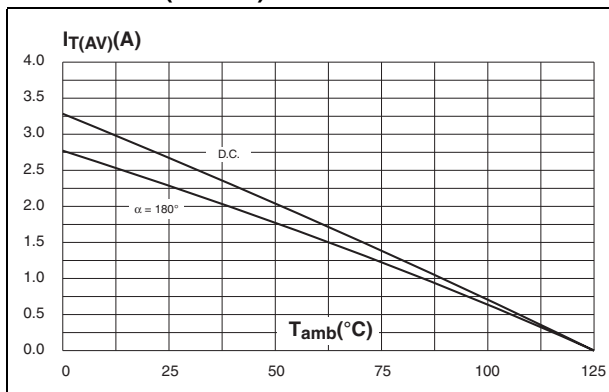

**Figure 4. Relative variation of thermal impedance versus pulse duration**

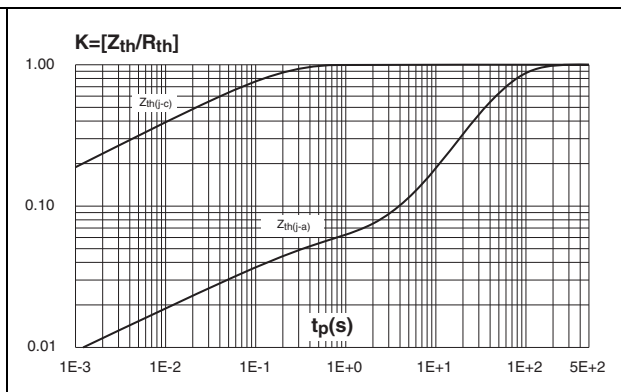

**Figure 5. Relative variation of gate trigger current, holding current and latching current versus junction temperature**

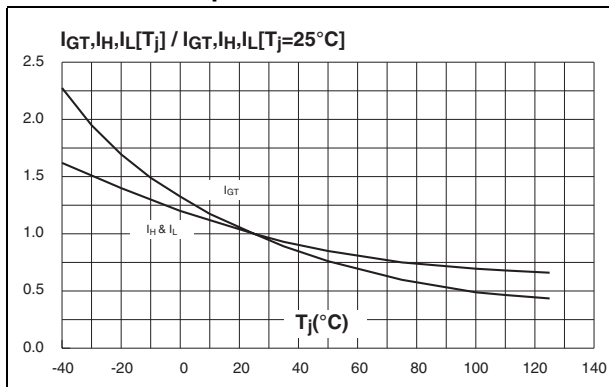

**Figure 6. Surge peak on-state current versus number of cycles**

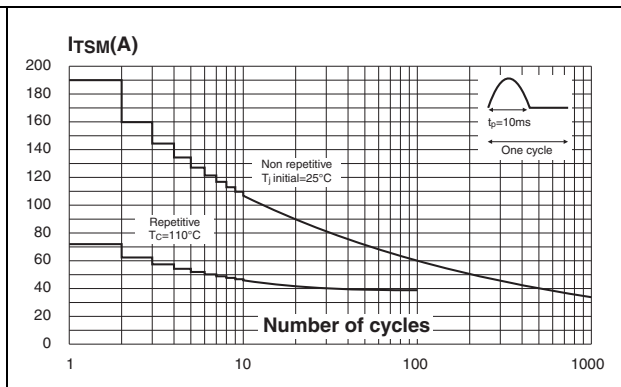

**Figure 7. Non-repetitive surge peak on-state current for a sinusoidal pulse with width  $t_p < 10$  ms, and corresponding values of  $I^2t$**

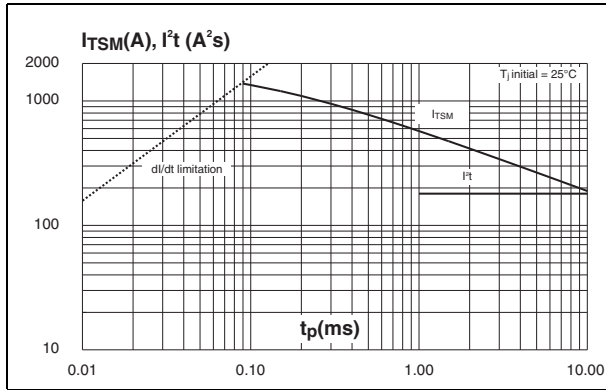

**Figure 8. On-state characteristics (maximum values)**

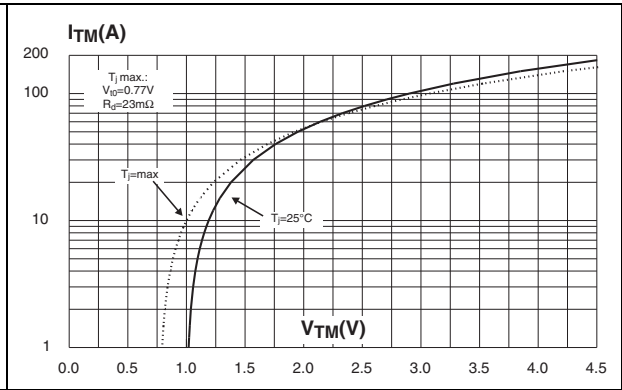

**Figure 9. Thermal resistance junction to ambient versus copper surface under tab (epoxy printed circuit board FR4, copper thickness: 35  $\mu\text{m}$ ) ( $D^2\text{PAK}$ )**

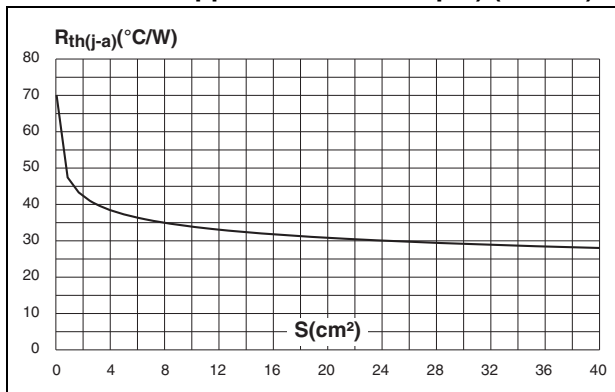

## 2 Ordering information scheme

Figure 10. TN1625

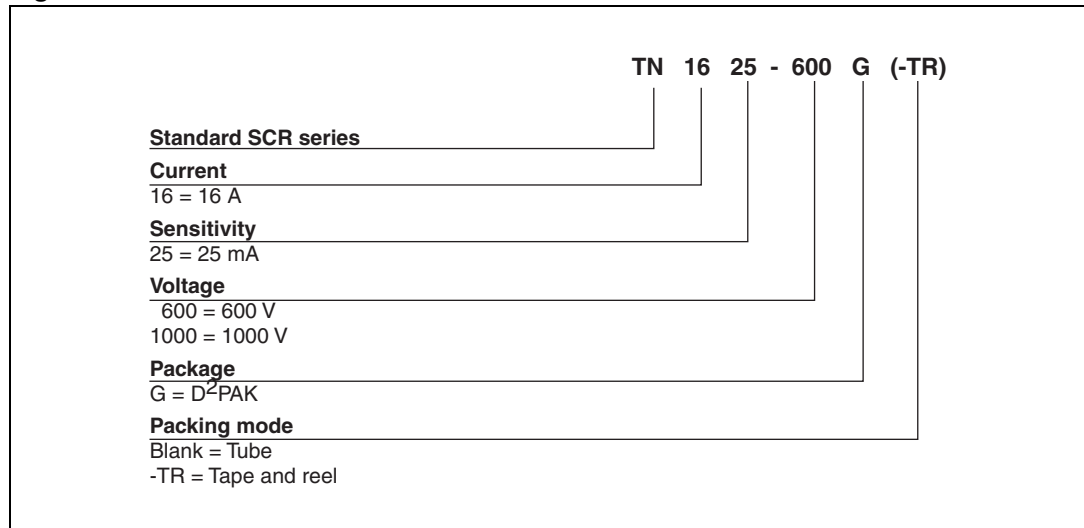
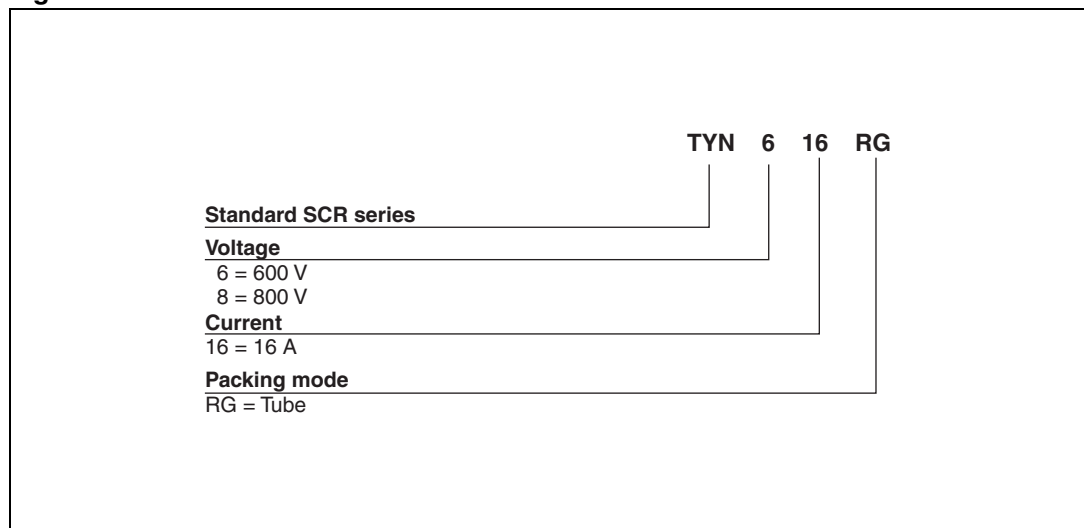

Figure 11. TYNx16



### 3 Package information

- Epoxy meets UL94,V0
- Cooling method: C
- Recommended torque value: 0.4 - 0.6 N·m

In order to meet environmental requirements, ST offers these devices in ECOPACK® packages. These packages have a lead-free second level interconnect. The category of second level interconnect is marked on the package and on the inner box label, in compliance with JEDEC Standard JESD97. The maximum ratings related to soldering conditions are also marked on the inner box label. ECOPACK is an ST trademark. ECOPACK specifications are available at: [www.st.com](http://www.st.com).

**Table 5. TO-220AB dimensions**

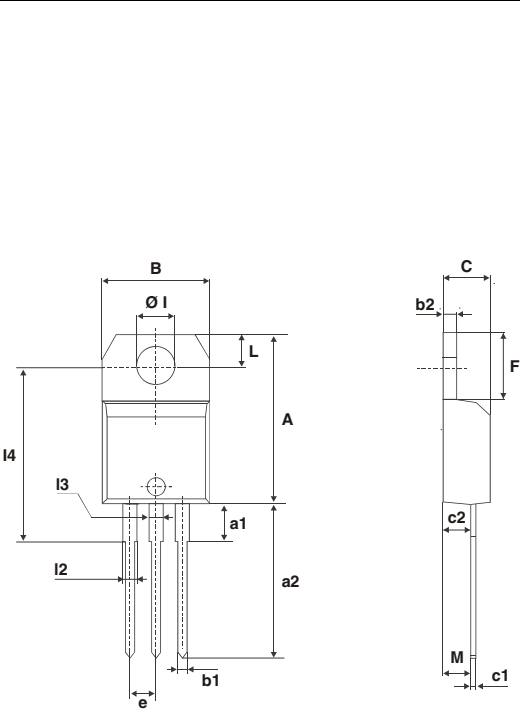

Ref.	Dimensions					
	Millimeters			Inches		
	Min.	Typ.	Max.	Min.	Typ.	Max.
A	15.20		15.90	0.598		0.625
a1		3.75			0.147	
a2	13.00		14.00	0.511		0.551
B	10.00		10.40	0.393		0.409
b1	0.61		0.88	0.024		0.034
b2	1.23		1.32	0.048		0.051
C	4.40		4.60	0.173		0.181
c1	0.49		0.70	0.019		0.027
c2	2.40		2.72	0.094		0.107
e	2.40		2.70	0.094		0.106
F	6.20		6.60	0.244		0.259
ØI	3.75		3.85	0.147		0.151
I4	15.80	16.40	16.80	0.622	0.646	0.661
L	2.65		2.95	0.104		0.116
I2	1.14		1.70	0.044		0.066
I3	1.14		1.70	0.044		0.066
M		2.60			0.102	

Table 6. D<sup>2</sup>PAK dimensions

Ref.	Dimensions					
	Millimeters			Inches		
	Min.	Typ.	Max.	Min.	Typ.	Max.
A	4.30		4.60	0.169		0.181
A1	2.49		2.69	0.098		0.106
A2	0.03		0.23	0.001		0.009
B	0.70		0.93	0.027		0.037
B2	1.25	1.40		0.048	0.055	
C	0.45		0.60	0.017		0.024
C2	1.21		1.36	0.047		0.054
D	8.95		9.35	0.352		0.368
E	10.00		10.28	0.393		0.405
G	4.88		5.28	0.192		0.208
L	15.00		15.85	0.590		0.624
L2	1.27		1.40	0.050		0.055
L3	1.40		1.75	0.055		0.069
R	0.40			0.016		
V2	0°		8°	0°		8°

Figure 12. Footprint (dimensions in mm)

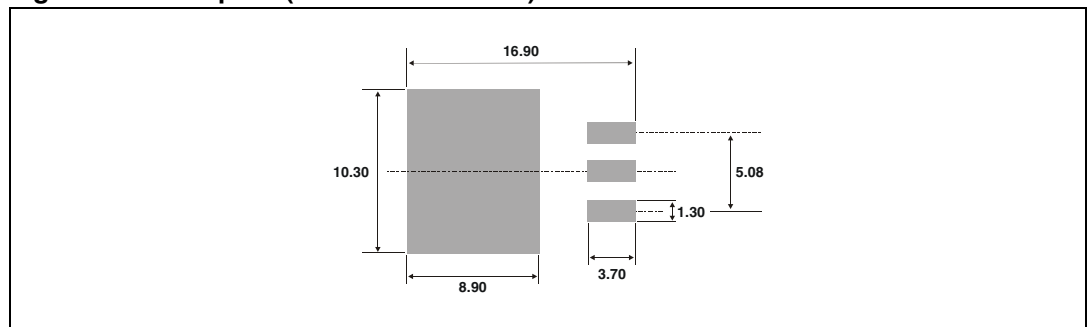

## 4 Ordering information

**Table 7. Ordering information**

Order code <sup>(1)</sup>	Marking <sup>(1)</sup>	Package	Weight	Base qty	Delivery mode
TN1625-x00G	TN1625x00G	D <sup>2</sup> PAK	1.5 g	50	Tube
TN1625-x00G-TR	TN1625x00G	D <sup>2</sup> PAK	1.5 g	1000	Tape and reel
TYNx16RG	TYNx16	TO-220AB	2.3 g	50	Tube

1. x indicates votage, 6, 8 or 10 for 600, 800 and 1000 V respectively

## 5 Revision history

**Table 8. Document revision history**

Date	Revision	Changes
Apr-2002	4A	Last update.
13-Feb-2006	5	TO-220AB delivery mode changed from bulk to tube. ECOPACK statement added.
07-Nov-2007	6	Reformatted to current standards. <a href="#">Table 2</a> : I <sub>T(RMS)</sub> value corrected from 12 A to 16 A



**Please Read Carefully:**

Information in this document is provided solely in connection with ST products. STMicroelectronics NV and its subsidiaries ("ST") reserve the right to make changes, corrections, modifications or improvements, to this document, and the products and services described herein at any time, without notice.

All ST products are sold pursuant to ST's terms and conditions of sale.

Purchasers are solely responsible for the choice, selection and use of the ST products and services described herein, and ST assumes no liability whatsoever relating to the choice, selection or use of the ST products and services described herein.

No license, express or implied, by estoppel or otherwise, to any intellectual property rights is granted under this document. If any part of this document refers to any third party products or services it shall not be deemed a license grant by ST for the use of such third party products or services, or any intellectual property contained therein or considered as a warranty covering the use in any manner whatsoever of such third party products or services or any intellectual property contained therein.

**UNLESS OTHERWISE SET FORTH IN ST'S TERMS AND CONDITIONS OF SALE ST DISCLAIMS ANY EXPRESS OR IMPLIED WARRANTY WITH RESPECT TO THE USE AND/OR SALE OF ST PRODUCTS INCLUDING WITHOUT LIMITATION IMPLIED WARRANTIES OF MERCHANTABILITY, FITNESS FOR A PARTICULAR PURPOSE (AND THEIR EQUIVALENTS UNDER THE LAWS OF ANY JURISDICTION), OR INFRINGEMENT OF ANY PATENT, COPYRIGHT OR OTHER INTELLECTUAL PROPERTY RIGHT.**

**UNLESS EXPRESSLY APPROVED IN WRITING BY AN AUTHORIZED ST REPRESENTATIVE, ST PRODUCTS ARE NOT RECOMMENDED, AUTHORIZED OR WARRANTED FOR USE IN MILITARY, AIR CRAFT, SPACE, LIFE SAVING, OR LIFE SUSTAINING APPLICATIONS, NOR IN PRODUCTS OR SYSTEMS WHERE FAILURE OR MALFUNCTION MAY RESULT IN PERSONAL INJURY, DEATH, OR SEVERE PROPERTY OR ENVIRONMENTAL DAMAGE. ST PRODUCTS WHICH ARE NOT SPECIFIED AS "AUTOMOTIVE GRADE" MAY ONLY BE USED IN AUTOMOTIVE APPLICATIONS AT USER'S OWN RISK.**

Resale of ST products with provisions different from the statements and/or technical features set forth in this document shall immediately void any warranty granted by ST for the ST product or service described herein and shall not create or extend in any manner whatsoever, any liability of ST.

ST and the ST logo are trademarks or registered trademarks of ST in various countries.

Information in this document supersedes and replaces all information previously supplied.

The ST logo is a registered trademark of STMicroelectronics. All other names are the property of their respective owners.

© 2007 STMicroelectronics - All rights reserved

STMicroelectronics group of companies

Australia - Belgium - Brazil - Canada - China - Czech Republic - Finland - France - Germany - Hong Kong - India - Israel - Italy - Japan - Malaysia - Malta - Morocco - Singapore - Spain - Sweden - Switzerland - United Kingdom - United States of America

[www.st.com](http://www.st.com)



单击下面可查看定价，库存，交付和生命周期等信息

[>>STMicro\(意法半导体\)](#)